

AMiLA®

ELDICO
sport

1978 **45** ΧΡΟΝΙΑ 2023

κατάλογος και
προκαταλόγος

2024

Σύμβουλος Αγορών

AMiLA®

in impulse

ReNeGaDE

SPIRIT

SOLE

TOTAL GYM 

BODYCRAFT





username



Οι Επιλογές Μας Δηλώνουν Ποιοι Είμαστε

Στην **ΕΛΔΙΚΟ** όλα είναι μία αλυσίδα αποτελούμενη από συνεργάτες και προμηθευτές, η οποία στηρίζεται σε διαδικασίες δοκιμασμένες στο χρόνο.

Σε επίπεδο brand name δημιουργήσαμε τα **ESCAPE** και **AMILA**, τα οποία αυτή τη στιγμή αναπτύσσουμε περαιτέρω. Βάζοντας τον πελάτη στο κέντρο των διαδικασιών μας, επιδιώκουμε να γίνουμε πρότυπο πελατοκεντρικής εταιρείας και πρώτη επιλογή των πελατών μας.

Αγαπάμε τους ανθρώπους μας, αγαπάμε και σεβόμαστε τους πελάτες μας και προσπαθούμε μέσα από την ομαδική εργασία να τους υπηρετήσουμε σωστά **κερδίζοντας έτσι επάξια και τον δικό τους σεβασμό.**

ISO 9001:2015

Για να εξασφαλίσει την ποιότητα και ασφάλεια των προϊόντων της, η **ΕΛΔΙΚΟ** φρόντισε να εγκαταστήσει στις λειτουργίες της Σύστημα Διασφάλισης Ποιότητας [ΣΔΠ] σύμφωνα με το Διεθνές πρότυπο **ISO 9001:2015**.

Πρακτικά, αυτό σημαίνει ότι η **ΕΛΔΙΚΟ** πέρασε από όλα τα απαιτούμενα στάδια προετοιμασίας και πλέον περνάει με επιτυχία τις επιθεωρήσεις που πραγματοποιούνται μία ή δύο φορές το χρόνο.

Με το **ISO 9001:2015** διασφαλίζεται η εισαγωγή, η παραλαβή, η παραγγελιοληψία, η συσκευασία και αποστολή των προϊόντων της μέσα από **συνεχείς, αυστηρούς ελέγχους** που αποτελούν αναπόσπαστο κομμάτι της λειτουργίας της.

Η δέσμευση **ISO 9001:2015** συνάδει με την επιθυμία της **ΕΛΔΙΚΟ** να δείχνει τον μέγιστο σεβασμό στον πελάτη της, να αντιμετωπίζει με σοβαρότητα και επαγγελματισμό κάθε πιθανό πρόβλημα και να κινείται ανοιχτά για την επικοινωνία και την επίλυσή του.

Εφαρμόζοντας τη νομοθεσία τόσο του ελληνικού κράτους, όσο και της Ευρωπαϊκής Ένωσης σχετικά με την ασφαλή φύση των προϊόντων της και την ασφάλεια των καταναλωτών, η **ΕΛΔΙΚΟ** εκπληρώνει ουσιαστικά τη φιλοδοξία της να έχει στο επίκεντρο της προσοχής της τον πελάτη, οικοδομώντας γύρω του ένα **Σύστημα Διασφάλισης Ποιότητας** που τον εξασφαλίζει σε όλα τα επίπεδα.



Το Όραμά Μας

Να είμαστε μια πρωτοπόρα εταιρεία με ισχυρό brand name και καινοτόμα προϊόντα, πρότυπο για πελάτες και ανταγωνιστές, πρώτη επιλογή για συνεργάτες. Μέσω της μάθησης, της προσωπικής ανέλιξης και της ουσιαστικής συμμετοχής στην πρόοδό της να καλλιεργεί στους εργαζομένους της κουλτούρα οργάνωσης, καινοτομίας, ομαδικής εργασίας και πνεύμα αλληλοσεβασμού εντός και εκτός εταιρείας.



Εταιρική Κοινωνική Ευθύνη

Η **ΕΛΔΙΚΟ ΣΠΟΡ ΜΟΝ. ΑΕΕ** πρωτοπορεί στον κλάδο των εισαγωγών και της εμπορίας αθλητικών, εποχιακών και ειδών εξοχής, ενώ παράλληλα πρωτοστατεί στο σύστημα Εναλλακτικής Διαχείρισης.

Η προστασία του περιβάλλοντος αποτελεί σημαντική της βίβληψη, γι' αυτό και συμμετέχει στο **Σύστημα Συñ. Εναλλακτικής Διαχείρισης "ΑΝΑΚΥΚΛΩΣΗ"** της Ελληνικής Εταιρείας Αξιοποίησης Ανακύκλωσης ενώ παράλληλα υλοποιεί **πρόγραμμα μείωσης του πλαστικού στις συσκευασίες**, αντικαθιστώντας το με ανακυκλώσιμο χαρτί.

Η **ΕΛΔΙΚΟ ΣΠΟΡ ΜΟΝ. ΑΕΕ**, στα πλαίσια της **Εταιρικής Κοινωνικής Ευθύνης**, έχει τη χαρά να βοηθά την προσπάθεια του φοιτητικού σωματείου **"Circle Club"**, που δραστηριοποιείται στους τομείς του μπάσκετ, του ποδοσφαίρου, του τένις, και του cheerleading, μέσα από τα προϊόντα που παρέχει δωρεάν για τις προπονήσεις και τα πρωταθλήματα που συμμετέχουν.





Επιλογή Προμηθευτών

Η επιλογή των κατάλληλων προμηθευτών γίνεται μέσα από μια εκτεταμένη τράπεζα πληροφοριών η οποία **εμπλουτίζεται συνεχώς από τις επισκέψεις και επαφές μας σε διεθνείς εκθέσεις.**

Τα κριτήρια μας είναι αυστηρά αναφορικά με την ποιότητα των προσφερόμενων προϊόντων και βασίζονται σε μια δυνατή - αμφίδρομη σχέση επικοινωνίας.

Συνεργαζόμαστε με εργοστάσια που κατασκευάζουν ποικίλα προϊόντα, τα οποία προμηθεύουν, επίσης, επώνυμα brands και φυσικά είναι **πιστοποιημένα με ISO**, ώστε να έχουμε εξασφαλισμένη την οργάνωση και την εξυπηρέτηση από μέρους τους.

Έχουμε επιλέξει ορισμένα από τα καλύτερα εργοστάσια της Κίνας, της Ταϊβάν και του Πακιστάν, με στελέχη που γνωρίζουν καλά την αγγλική γλώσσα, προς αποφυγή παρανοήσεων, τα οποία ανταποκρίνονται σε κάθε μας αίτημα, ηλεκτρονικώς, εντός μίας ημέρας.

Πάγια πολιτική μας είναι να παραμένουμε πιστοί στους προμηθευτές μας, καθώς **επενδύουμε χρόνο και χρήμα στη συνεργασία μας** -με πολυημερές επισκέψεις στα εργοστάσιά τους για επιτόπου έρευνα- ώστε να έχουμε τη βέλτιστη συνεργασία.

Επιλογή Προϊόντων

Το τμήμα πωλήσεων μας μεταφέρει τις δικές σας προτάσεις ώστε να καλύψουμε τυχόν κενά στην αγορά, ενώ το τμήμα εισαγωγών συγκεντρώνει στοιχεία, ώστε να καθορίσει τόσο τις προδιαγραφές των νέων προϊόντων, όσο και την επιθυμητή τιμή αγοράς.

Εξασφαλίζουμε τους Συνεργάτες μας

Η πολύχρονη εμπειρία μας, η βαθιά γνώση της ελληνικής αγοράς και κυρίως κάθε προϊόντος, είναι στη διάθεσή σας ώστε να είμαστε πάντα σε θέση να σας εξασφαλίσουμε κάτι ακόμα καλύτερο. Απόδειξη το γεγονός ότι **έχουμε βελτιώσει όλα τα προϊόντα που εισάγουμε**, ώστε να ανταποκρίνονται στις απαιτήσεις μας και να είναι όλα λειτουργικά, ακόμα και αυτά που διατίθενται σε ιδιαίτερα ελκυστικές τιμές.

1. Σας παρέχουμε ποιοτικά σωστά **προϊόντα με συγκεκριμένες προδιαγραφές**, χωρίς λάθη, από έμπειρους προμηθευτές που έχουμε εκπαιδεύσει.
2. Σας προμηθεύουμε με προϊόντα **σταθερά υψηλής ποιότητας**.
3. Σας εξασφαλίζουμε **διαχρονικά σωστό service**.
4. Κερδίζουμε την εμπιστοσύνη σας στα προϊόντα μας χάρη στην **απόρροια ομαλή συνεργασία μας**.

- ◀ Επίσκεψη στο εργοστάσιο κατασκευής πάγκων της AMILA. Επιθεώρηση βαφής και laser cut.



- ▲ Η ποιότητα της συσκευασίας και της προστασίας των προϊόντων πριν συσκευαστούν σε κουτιά, είναι ζωτικής σημασίας για την προστασία των προϊόντων κατά την μεταφορά και αποθήκευση. Η γνώση για όλα τα στάδια της συσκευασίας είναι σημαντική για την κατανόηση της προσφερόμενης ποιότητας από το εργοστάσιο.



- ▲ Επίσκεψη στο εργοστάσιο κατασκευής δίσκων της AMILA. Επιθεώρηση διαδικασίας π्लाστικοποίησης.

Οι διαδικασίες μας αποτελούν εγγύηση επιτυχίας

Η ΕΛΔΙΚΟ ΣΠΟΡ ΜΟΝ. ΑΕΕ έχει καθορίσει διαδικασίες τις οποίες ακολουθεί προκειμένου να πετύχει:

- Ποιότητα Προϊόντων
- Διαθεσιμότητα Προϊόντων
- Αποθέματα Ανταλλακτικών



Άφιξη

1. Κατά την άφιξη του κοντέινερ στα ειδικά ντοκ, γίνεται προσεκτική εκφόρτωση των προϊόντων χρησιμοποιώντας τα πλήρον κατάλληλα μέσα, ανάλογα με το είδος και την συσκευασία του εμπορεύματος.
2. Κατά την διάρκεια της εκφόρτωσης γίνεται ένας συνοπτικός έλεγχος που αφορά:
 - Προδιαγραφές, χρώματα, barcodes και κωδικούς.
 - Ελέγχεται η συσκευασία ώστε να είναι σε άριστη κατάσταση. Εάν βρεθεί απόκλιση, αποθηκεύεται σε ιδιαίτερο μέρος.
3. Στο τέλος, ακολουθεί καταχώρηση και εισαγωγή στην αποθήκη με χρήση barcode scanners.



Μηχανογράφηση

Η **ELDICO** είναι πλήρως μηχανογραφημένη στα πρότυπα **ERP [Enterprise Resource Planning]** και διαθέτει 3 servers, τελευταίας γενιάς, με 5 δίσκους έκαστος (raid) για μεγαλύτερη ασφάλεια.



Ζύγιση
ποιοτικός έλεγχος
και έλεγχος με
χρήση barcode scanner



Φύλαξη

Η αποθήκη που φιλοξενεί τα προϊόντα είναι καθαρή και τακτοποιημένη, ενώ η ύπαρξη υπευθύνων περιοχών και οι εβδομαδιαίοι έλεγχοι μας έχουν αποφέρει 98% σωστές θέσεις/ράφι και 97% καθαρά εμπορεύματα.

Σε έναν ιδιόκτητο χώρο συνολικής έκτασης 4200m² για γραφεία και αποθήκες, στο Βοτανικό, βρίσκεται το κεντρικό κτήριο της ΕΛΔΙΚΟ.



Αποψη της αποθήκης μας στη Θεσ/νίκη, συνολικής έκτασης 4300m² με δυνατότητα αποθήκευσης 85 container 40HQ.

Παραγγελιοληψία

Γίνεται από τη γραμματεία πωλήσεων και από τους πωλητές σε Αθήνα και Θεσ/νίκη. Τόσο οι πωλητές όσο και η γραμματεία πωλήσεων και οι συντονιστές παραγγελιών εκτός της πολυετούς πείρας (οι περισσότεροι πάνω από 15 χρόνια), εκπαιδεύονται διαρκώς και είναι σε θέση να απαντούν στις ερωτήσεις σας και να σας συμβουλεύουν για την αγορά ή τη χρήση των προϊόντων που σας ενδιαφέρουν.

Το ψηφιακό τηλεφωνικό κέντρο μας επιτρέπει να **ανοίγουμε αυτομάτως την καρτέλα** και να **εισάγουμε άμεσα την παραγγελία σας**, η οποία ενδέχεται ακόμα και να καταγραφεί, για την αποφυγή οποιουδήποτε πιθανού λάθους.



Οι εγκαταστάσεις και ο στόλος οχημάτων των αποθηκών της ΕΛΔΙΚΟ στη Βόρεια Ελλάδα.

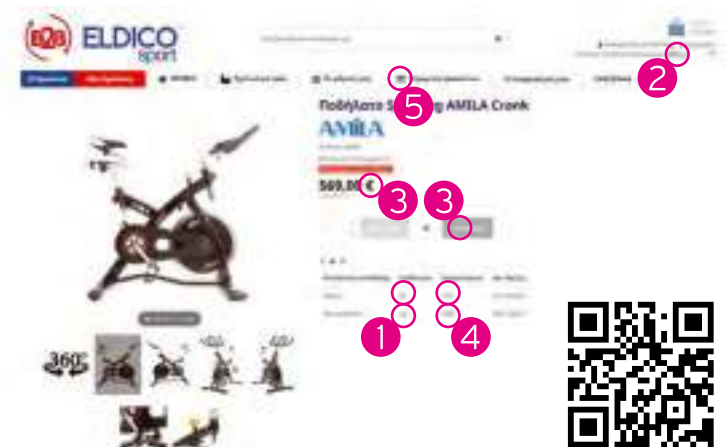

Η ανανεωμένη πλατφόρμα B2B (Business to Business)

Η υπηρεσία είναι συνδεδεμένη με το εμπορικό πρόγραμμα της εταιρίας ώστε να παρέχει άμεσα και σε πραγματικό χρόνο πληροφόρηση.

Εκτός από τις διαθεσιμότητες των προϊόντων, σε κάθε μια από τις δύο αποθήκες μας (1), οι εγγεγραμμένοι χρήστες μπορούν να επιλέξουν την αποθήκη παραγγελίας τους (2) και να δουν την χονδρική τιμή καταλόγου και την τιμή αγοράς τους (3). Επίσης, παρέχεται η πληροφόρηση για την αναμενόμενη ποσότητα καθώς και για την ημερομηνία επόμενης παραλαβής (4).

Επιπλέον, από την λίστα των προϊόντων κάθε κατηγορίας, μπορούν να προστεθούν προϊόντα στη λίστα σύγκρισης (5) και να εμφανιστούν, σε στήλες, τα χαρακτηριστικά των επιλεγμένων προϊόντων.

Δείτε το δίκτυο **επιλεγμένων συνεργατών** μας στη διεύθυνση eldico.gr/partners ►



Τα προϊόντα της ΕΛΔΙΚΟ βρίσκονται σε περισσότερα από 5.000 σημεία πώλησης. Από αυτά περίπου 1.600 αφορούν απ' ευθείας πωλήσεις και 3.500 είναι σημεία πώλησης μέσω 50 μεγάλων συνεργατών. Στα Βαλκάνια και στην Κύπρο η ΕΛΔΙΚΟ έχει παρουσία σε 50 επιπλέον σημεία πώλησης, κυρίως απ' ευθείας.

Με **έμφαση στην ποιότητα**, η αποστολή των εμπορευμάτων αποτελεί πολύ σημαντικό κριτήριο για την ΕΛΔΙΚΟ ΣΠΟΡ ΜΟΝ. ΑΕΕ και ένα από τα τρία (3) βασικότερα κριτήρια για την πιστοποίησή μας.



Εκτέλεση Παραγγελιών

Το προσωπικό της αποθήκης μας διαθέτει εμπειρία ετών, γι' αυτό και μπορεί να κάνει picking του σωστού κωδικού, **χωρίς οποιoδήποτε ελάττωμα** στα προϊόντα ή την συσκευασία τους.

Στη συνέχεια, κάθε παραγγελία κατεβαίνει στον χώρο συσκευασίας και **σκανάρεται τεμάχιο προς τεμάχιο**, ώστε να γίνει **οργανωμένη και σωστή αποστολή**, μηδενίζοντας έτσι την εμφάνιση λαθών.

Μετά τον τελικό έλεγχο ποσότητας και την επιβεβαίωση του κωδικού, συμπληρώνεται ο αριθμός του κιβωτίου και ο υπεύθυνος το συσκευάζει καλά, δίνοντας σημασία στη σωστή αναγραφή ονομάτων και αριθμού δεμάτων, ενώ παράλληλα φροντίζει να γίνει με ταχύτητα και ασφάλεια η φόρτωση.

Σημαντικό είναι το γεγονός πως **το τιμολόγιό μας αποτελεί ταυτόχρονα packing list** ώστε η παραλαβή να γίνεται χωρίς λάθη και απρόοπτα.



Στην προσπάθειά μας να βελτιώσουμε την έκδοση του καταλόγου μας, λαμβάνουμε πάντοτε σοβαρά υπόψη μας τα σχόλια και τις παρατηρήσεις σας, για τις οποίες σας ευχαριστούμε θερμά.

Βελτιώνουμε συνεχώς τον κατάλογο μας ακολουθώντας τις βέλτιστες πρακτικές στην παρουσίαση προϊόντων, και φροντίζοντας να τον κάνουμε κάθε χρόνο πιο λειτουργικό. Πιστεύουμε ακράδαντα ότι ο παρών κατάλογος θα γίνει χρήσιμο εργαλείο στα χέρια σας για την ολοκληρωμένη ενημέρωσή σας, εφόσον μπορεί να σας βοηθήσει στην σωστή επιλογή των προϊόντων σας.

Επίσκεψη του τεχνικού μας στο εργοστάσιο κατασκευής κινητήρων ► για ενημέρωση και έλεγχο της ποιότητας των διαδικασιών του εργοστασίου.

Φόρτωση

Τα προϊόντα αναχωρούν **άριστα συσκευασμένα** από τις εγκαταστάσεις μας, ώστε να αποφεύγεται κάθε δυσάρεστη έκπληξη από εμπλεκόμενες εταιρείες μεταφορών.



Διανομή

Η διανομή πραγματοποιείται με **3 μεγάλα (10T)** και **3 μικρότερα ιδιόκτητα φορτηγά (5T)**, που εξασφαλίζουν την απαιτούμενη ταχύτητα εξυπηρέτησης, την αμεσότητα και -κυρίως- την ασφάλεια στις μεταφορές.

Ο συντονισμός της παράδοσης είναι αρμοδιότητα του υπεύθυνου της αποθήκης ώστε να είμαστε σίγουροι ότι θα είμαστε **απόλυτα συνεπείς απέναντί σας**.



Έρευνα και Εξέλιξη

Σε συνεργασία με τη **Σχολή Επιστημών Υγείας & Πρόνοιας του Πανεπιστημίου Δυτικής Αττικής**, για το πρόγραμμα "Εκπαίδευση και Θεραπευτική Άσκηση με την εφαρμογή της μεθόδου Clinical Pilates" του **Κέντρου Δια Βίου Μάθησης η ΕΛΔΙΚΟ** βρίσκεται σε διαρκή επαφή, διαθέτοντας τα προϊόντα **AMILA** για τις ανάγκες των προγραμμάτων και των εργαστηριακών μετρήσεων που εκπονούνται, λαμβάνοντας σημαντικές πληροφορίες για την εξέλιξη των βοηθημάτων που παρέχει.



Διαρκής Εκπαίδευση

Στην προσπάθειά μας να σας εξυπηρετούμε καλύτερα, ακολουθούμε τη **φιλοσοφία διαρκούς εκπαίδευσης**. Το προσωπικό της αποθήκης εκπαιδεύεται τακτικά σε θέματα logistics, συσκευασίας, μηχανογράφησης, ασφάλειας αποθήκης και πυρόσβεσης. Η γραμματεία πωλήσεων και οι πωλητές εκπαιδεύονται τακτικά και έχουν τη δυνατότητα να απαντήσουν στις περισσότερες ερωτήσεις σας, καθώς και να σας βοηθήσουν να επιλέξετε τα σωστά εμπορεύματα για τις ανάγκες των πελατών σας.

Δημιουργία Περιεχομένου

Οι σύγχρονες απαιτήσεις της ψηφιακής εποχής δημιουργούν συνεχώς ανάγκες για ορθό και πλουσιότερο περιεχόμενο. Το τμήμα Marketing της **ΕΛΔΙΚΟ** επανδρώθηκε με νέο προσωπικό που εξειδικεύεται στην **κατασκευή φωτογραφιών 360 μοιρών***, **videos συναρμολόγησης και λειτουργίας, ασκησιοδημιουργιών και κειμένων** σε συνεργασία με επιστήμονες φυσικής αγωγής και personal trainers, που σκοπό έχουν τη δημιουργία **εργαλείων προώθησης** τα οποία θα κάνουν τον υποψήφιο χρήστη να αισθάνεται όχι απλά ότι γνωρίζει αλλά πως **κρατά στα χέρια του το προϊόν, πριν καν το αποκτήσει**.



* Επικοινωνήστε μαζί μας για να σας κατευθύνουμε για την παροχή και χρήση των φωτογραφιών 360°.

Επενδύοντας διαρκώς στο ανθρώπινο δυναμικό, η ΕΛΔΙΚΟ ΣΠΟΡ ΜΟΝ. ΑΕΕ στελεχώνεται από **καταρτισμένο προσωπικό**, με **υψηλή εξειδίκευση** (οικονομολόγους, γυμναστές, μηχανικούς, τεχνολόγους) και **πολυετή εμπειρία** στο αντικείμενο ενασχόλησής τους.

Στοχεύοντας πάντα στις σύγχρονες ανάγκες της εποχής και τις απαιτήσεις που έχουν σε πολυσιχιδείς γνώσεις, η εταιρεία, παράλληλα με τις επενδύσεις σε τεχνολογικά μέσα, εφαρμόζει συνεχές πρόγραμμα επιμόρφωσης του προσωπικού μέσω των εσωτερικών διαδικασιών εκπαίδευσης του Συστήματος Ποιότητας (ISO 9001:2015) και συμμετοχών σε επιμορφωτικά σεμινάρια τρίτων φορέων.

▷ ΔΠ ΑΠΟΘΗΚΑΡΙΟΣ



Δημήτρης ΠΑΝΤΕΛΙΔΗΣ
Αποθηκάριος
Εσωτερικός Αριθμός: 114
Τηλέφωνο: 6955 584472

▷ ΑΚ ΧΕΙΡΙΣΤΗΣ SCANNER



Άγνης ΚΑΦΡΙΤΣΑΣ
Χειριστής Scanner
Εσωτερικός Αριθμός: 114

▷ ΘΒ ΧΕΙΡΙΣΤΗΣ SCANNER



Αθανάσιος ΒΑΡΔΑΚΑΣ
Χειριστής Scanner
Εσωτερικός Αριθμός: 124

▷ ΒΔ ΕΚΤΕΛΕΣΗ ΠΑΡΑΓΓΕΛΙΩΝ



Βασίλης ΔΕΜΠΙ
Εκτέλεση Παραγγελιών
Εσωτερικός Αριθμός: 124

▷ ΔΤ ΕΚΤΕΛΕΣΗ ΠΑΡΑΓΓΕΛΙΩΝ



Αθηνάο ΤΡΕΜΠΙΣΚΑ
Εκτέλεση Παραγγελιών
Εσωτερικός Αριθμός: 124

Το δυνατότερο κομμάτι της εταιρείας είναι οι άνθρωποί της... ...και οι Πελάτες η Πρώτη μας Προτεραιότητα

▷ ΘΚ ΟΔΗΓΟΣ



Θεόδ. ΚΑΝΔΗΛΙΩΤΗΣ
Οδηγός
Εσωτερικός Αριθμός: 124
Τηλέφωνο: 6959 997120

▷ ΓΜ ΟΔΗΓΟΣ



Γιάννης ΜΑΓΓΙΝΑΣ
Οδηγός
Εσωτερικός Αριθμός: 124
Τηλέφωνο: 6945 934803

▷ ΚΚ ΟΔΗΓΟΣ



Κώστας ΚΑΡΙΤΖΗΣ
Οδηγός
Εσωτερικός Αριθμός: 124

▷ ΘΒ ΧΕΙΡΙΣΤΗΣ SCANNER



Βαλάντης ΚΟΥΓΙΑΣ
Βοηθός Αποθήκης
Εσωτερικός Αριθμός: 124

▷ ΠΣ ΒΟΗΘΟΣ ΑΠΟΘΗΚΗΣ



Πέτρος ΣΚΕΜΠΙ
Βοηθός Αποθήκης
Εσωτερικός Αριθμός: 124

▷ ΛΤ ΑΠΟΘΗΚΑΡΙΟΣ



Λευτέρης ΤΣΑΜΠΟΥΡΑΣ
Αποθηκάριος
Εσωτερικός Αριθμός: 210
Τηλέφωνο: 6955 440986

▷ ΧΤ ΒΟΗΘΟΣ / ΟΔΗΓΟΣ



Χρήστος ΤΖΙΜΑΣ
Οδηγός - Βοηθός Αποθήκης
Εσωτερικός Αριθμός: 210
Τηλέφωνο: 6956 036266

▷ ΓΤ ΑΠΟΘΗΚΗ



Γιάννης ΤΣΙΦΤΣΗΣ
Εκτέλεση Παραγγελιών
Εσωτερικός Αριθμός: 210

▷ ΧΚ ΑΠΟΘΗΚΗ



Χαράλαμπος ΚΕΣΚΙΝΙΔΗΣ
Εκτέλεση Παραγγελιών
Εσωτερικός Αριθμός: 210

▷ ΜΔ ΕΣΩΤΕΡΙΚΕΣ ΕΡΓΑΣΙΕΣ



Μαρία ΔΕΛΗ
Εσωτερικές Εργασίες
Εσωτερικός Αριθμός: 210

Η εταιρεία δεν φέρει καμία ευθύνη για τυχόν τυπογραφικά λάθη και χρωματικές διαφορές λόγω εκτύπωσης που μπορεί να υπάρξουν στο συγκεκριμένο κατάλογο. Δεν υπάρχει δυνατότητα προεπιλογής χρωματισμού εκτός από αυτά που ήδη παράγει κάθε συνεργάτης της.

Η εταιρεία δεν ευθύνεται σε περίπτωση εξάντλησης των αποθεμάτων στα είδη και διατηρεί το δικαίωμα αλλαγής των αναγραφόμενων τιμών καθ' όλη τη διάρκεια του έτους. Παρακαλούμε για οποιαδήποτε απορία απευθυνθείτε στον πωλητή σας ή στο eMail: support@eldico.gr

▷ ΠΞ ΛΟΓΙΣΤΗΣ



Πάρις ΞΕΝΟΣ

Λογιστής

Εσωτερικός Αριθμός: 102
xenos@eldico.gr
Τηλέφωνο: 6949 956704

▷ ΓΒ ΣΥΜΒΟΥΛΟΣ ΑΓΟΡΩΝ



Γιάννης ΒΑΦΕΙΑΔΗΣ

Σύμβουλος Αγορών

Εσωτερικός Αριθμός: 207
vi@eldico.gr
Τηλέφωνο: 6974 142224

▷ ΓΝ ΣΥΜΒΟΥΛΟΣ ΑΓΟΡΩΝ



Γιώργος ΝΤΑΝΑΣΗΣ

Σύμβουλος Αγορών

Εσωτερικός Αριθμός: 105
gdan@eldico.gr
Τηλέφωνο: 6951 953364

▷ ΓΛ ΣΥΜΒΟΥΛΟΣ ΑΓΟΡΩΝ



Γιώργος ΛΑΝΤΖΑΚΗΣ

Σύμβουλος Αγορών

Εσωτερικός Αριθμός: 110
geolan@eldico.gr
Τηλέφωνο: 6948 208581

▷ ΘΡ ΣΥΜΒΟΥΛΟΣ ΑΓΟΡΩΝ



Θοδωρής ΡΟΚΑΣ

Σύμβουλος Αγορών

Εσωτερικός Αριθμός: 111
rokas@eldico.gr
Τηλέφωνο: 6945 558854

▷ ΝΘ ΜΗΧΑΝΟΓΡ. ΑΠΟΘΗΚΗΣ



Νίκος ΘΩΜΑΪΔΗΣ

Υπ. Μπχ/φρσις Αποθήκης

Εσωτερικός Αριθμός: 114
nth@eldico.gr

▷ ΙΚ ΤΗΛΕΦΩΝΙΚΟ ΚΕΝΤΡΟ



Ιωάννα ΚΑΣΣΑΡΗ

Τηλεφωνικό Εξυπηρέτηση

Εσωτερικός Αριθμός: 104
joanna@eldico.gr

▷ ΚΦ ΥΠ. ΜΗΧΑΝΟΓΡΑΦΗΣΗΣ



Κώστας ΦΡΑΓΚΟΥΛΗΣ

Τιμολόγηση - Μπχ/φρσις

Εσωτερικός Αριθμός: 112
fragoulis@eldico.gr

▷ ΝΔ ΥΠΕΥΘΥΝΟΣ ΕΙΣΑΓΩΓΩΝ



Νίκος ΔΟΥΛΟΥΓΕΡΗΣ

Υπεύθυνος Εισαγωγών

Εσωτερικός Αριθμός: 107
imports@eldico.gr

▷ ΜΠ ΒΟΗΘΟΣ ΕΙΣΑΓΩΓΩΝ



Μιχάλης ΠΑΠΑΪΩΑΝΝΟΥ
Β. Εισαγωγών - Αγοραστής

Εσωτερικός Αριθμός: 126
buyer@eldico.gr

▷ ΑΑ ΥΠ. ΤΕΧΝΙΚΟΥ ΤΜΗΜΑΤΟΣ



Αυγέρης ΑΥΓΕΡΙΝΟΣ

Υπεύθ. Τεχνικού Τμήματος

Εσωτερικός Αριθμός: 122
service.ath@eldico.gr
Τηλέφωνο: 6946 904598

▷ ΠΤ ΤΕΧΝΙΚΟΣ



Πέτρος ΓΡΗΓΟΡΙΑΔΗΣ

Τεχνικός

Εσωτερικός Αριθμός: 122
service.ath@eldico.gr
Τηλέφωνο: 6951 959708

▷ ΒΣ ΤΕΧΝΙΚΟΣ - ΟΔΗΓΟΣ



Βασίλης Χ'ΚΑΜΑΡΗΣ

Τεχνικός - Οδηγός

Εσωτερικός Αριθμός: 215
service.the@eldico.gr
Τηλέφωνο: 6943 076045

▷ ΜΣ ΤΙΜΟΛΟΓΙΣΗ - ΜΠΧ/ΦΙΣΗ



Μανώλης ΣΟΥΠΡΙΣ

Τιμολόγηση - Μπχ/φρσις

Εσωτερικός Αριθμός: 209
sales.the@eldico.gr

▷ ΧΓ ΤΙΜΟΛΟΓΙΣΗ - ΕΞΥΠΗΡΕΤΗΣΗ



Χρήστος ΓΚΟΓΚΑΚΗΣ

Τιμολόγηση - Εξυπηρέτηση

Εσωτερικός Αριθμός: 208
cg@eldico.gr
Τηλέφωνο: 6945 896511

▷ ΑΚ ΓΕΝΙΚΗ ΕΠΙΣΤΑΣΙΑ



Αλέκος ΚΑΤΣΙΛΙΔΗΣ

Γενική Επιστάσια

Εσωτερικός Αριθμός: 124
Τηλέφωνο: 6946 950638

▷ ΔΜ DESIGNER ΚΑΤΑΛΟΓΟΥ



Δημήτρης ΜΑΝΔΕΛΙΑΣ
Designer Καταλόγου

Εσωτερικός Αριθμός: 119
mandelias@eldico.gr

▷ ΚΣ B2B DESIGNER



Κώστας ΣΤΑΥΡΟΠΟΥΛΟΣ
B2B Web Designer

Εσωτερικός Αριθμός: 103
gd@eldico.gr

▷ ΘΑ GRAPHICS DESIGNER



Θοδωρής ΑΡΑΠΗΣ
Graphics Designer

Εσωτερικός Αριθμός: 113
gd@eldico.gr

▷ ΓΑΒ R&D, GDPR, IT, ISO, ΜΚΤΩ



Γιώργος Α. ΒΕΡΑΝΗΣ
R&D, GDPR, IT, ISO, Mktg

Εσωτερικός Αριθμός: 106
veranis@eldico.gr

“ Δεν θα πρέπει απλώς να ακούμε τη φωνή των πελατών μας και δεν θα πρέπει να ανταποκρινόμαστε μόνο σε αυτή, αλλά θα πρέπει να κάνουμε και το κάτι παραπάνω, που θα κάνει τους πελάτες μας πραγματικά ευτυχισμένους. ”

από την εναρκτήρια ομιλία του Γ. Μουσταφέλου για το έτος 2012

Πελατο-Μανία!

ΕΤΟΙΜΟΙ ΝΑ ΣΑΣ
ΕΞΥΠΗΡΕ-
ΤΗΣΟΥΜΕ

Νέα ριζική αλλαγή στον τρόπο που προσεγγίζουμε την συνεργασία μας με τους πελάτες μας Σύμβουλος Αγορών & "Πελατομανία"

Μέσα σε αυτά τα πλαίσια, σας παραδίνουμε το νέο ανανεωμένο μας κατάλογο που έχει φτιαχτεί πάνω σε μια διαφορετική φιλοσοφία. Αυτός ο κατάλογος φιλοδοξεί, κάποτε, να γίνει ένας πλήρης και σωστός **Σύμβουλος Αγορών**. Ο κύριος σκοπός του είναι να σας δίνει συμβουλές που αφορούν τις αγορές σας και τις πωλήσεις, και να βοηθά με τον τρόπο του στη δημιουργία για εσάς νέων ευκαιριών για αύξηση πωλήσεων. Οι απαντήσεις στις απορίες σας, καθώς και οι συμβουλές στην επιλογή των αγορών σας, θα ενσωματώνονται στις νέες βελτιωμένες εκδόσεις.

Οι Πελάτες μας στο Επίκεντρο της Προσοχής μας

Στην κορυφή της εταιρείας μας δεν είναι η διοίκηση αλλά οι **Πελάτες μας**. Το πραγματικό "αφεντικό"! Οι **Πελάτες** μας είναι αυτοί, που η συνεχής υποστήριξή τους εξασφαλίζει το παρόν και το μέλλον μας. Αντιλαμβανόμαστε πλήρως την ευθύνη μας σε όλους εσάς που μας **τιμήσατε με την επιλογή σας** και σας διαβεβαιώνουμε ότι θα κάνουμε τα πάντα για να ανταποκριθούμε σε αυτή την ευθύνη. Σαν αναγνώριση της υποστήριξής σας όλα αυτά τα χρόνια, με τον σημερινό **Κατάλογο - Σύμβουλο Αγορών** σας δίνουμε τη θέση που σας αξίζει και δεν είναι άλλη από την κορυφή της διοικητικής μας Πυραμίδας. Δεν είναι τυχαίο ότι δεύτεροι στη **Διοικητική Πυραμίδα** είναι οι εσωτερικοί μας πωλητές, είναι οι άνθρωποί μας που έρχονται σε καθημερινή επαφή μαζί σας. Κάνουμε τα πάντα και τους παρέχουμε ότι είναι δυνατόν ώστε να σας προσφέρουν κορυφαίες υπηρεσίες που εξάλλου τις αξίζετε.



Η οικογένεια της **ΕΛΔΙΚΟ ΣΠΟΡ ΜΟΝ. Α.Ε.Ε.**, παρότι μεγάλωσε αρκετά τα τελευταία χρόνια, εξακολουθεί να μην συγκαταλέγεται στις απρόσωπες εταιρείες. Και είμαστε υπερήφανοι γι' αυτό! Είναι συνειδητή επιλογή μας να σας παρουσιάζουμε κάθε χρόνο τα πρόσωπα των συναδέλφων - συνεργατών που είναι έτοιμα και εκπαιδευμένα να σας προσφέρουν την καλύτερη δυνατή εξυπηρέτηση.

Περνώντας και το τεσσαρακοστό έτος της λειτουργίας μας συνεχίζουμε να μαθαίνουμε και να επενδύουμε συνεχώς.



Ευχόμαστε υγεία και καλές δουλειές
Με εκτίμηση,
Γ. ΜΟΥΣΤΑΦΕΛΟΣ



ELDICO
sport



AMILA impulse ReNegaDE SPIRIT SOLE TOTALGYM BODYCRAFT MIKASA FOX40 SUNFLEX Butterfly STAG

ΣΥΝΟΠΤΙΚΟΣ ΚΑΤΑΛΟΓΟΣ ΕΠΙΚΟΙΝΩΝΙΑΣ ΕΛΔΙΚΟ ΣΠΟΡ ΜΟΝ. ΑΕΕ

ΑΘΗΝΑ

210 34 78 279

ΟΝΟΜΑΤΕΠΩΝΥΜΟ	ΕΣΩΤ.	ΚΙΝ. ΤΗΛ/ΝΟ	eMAIL	SKYPE NAME
---------------	-------	-------------	-------	------------

ΔΙΟΙΚΗΣΗ

Γιώργος Μουσταφέλος	155	—	gm@eldico.gr	georgemoustafelos
Ειρήνη Μουσταφέλου	101	—	me@eldico.gr	irene.moustafelou
Διονύσιος Μουσταφέλος	100	—	dm@eldico.gr	live:dionisaras13

ΣΥΜΒΟΥΛΟΙ ΑΓΟΡΩΝ

Γιώργος Λαντζάκης	110	6948 208 581	geolan@eldico.gr	george.lantzakis1
Γιώργος Ντίναςσης	105	6951 953 364	gdan@eldico.gr	Γιώργος Ντίναςσης
Θεόδωρος Ρόκας	111	6945 558 854	rokas@eldico.gr	rokas.eldico

ΤΗΛΕΦΩΝΙΚΗ ΕΞΥΠΗΡΕΤΗΣΗ

Κώστας Φραγκούλης	112	6946 904 595	fragoulis@eldico.gr	kos.fragoulis
Ιωάννα Κάσσαρη	104	—	joanna@eldico.gr	live:joanna.kassari

ΕΙΣΑΓΩΓΕΣ

Νίκος Δουλουγέρης	107	—	imports@eldico.gr	ndoulougeris
Μιχάλης Παπαϊωάννου	125	—	buyer@eldico.gr	live:.cid.64aa5b5df2e8ac1b

ΑΠΟΘΗΚΗ

Δημήτρης Παντελίδης	114	6955 584 472	—	—
Νίκος Θωμάϊδης	114	—	nth@eldico.gr	nth.eldico
Άγης Καφρίτσας	114	—	—	—
Αλέκος Κατσιλίδης	124	6946 950 638	—	—

ΜΕΤΑΦΟΡΕΣ

Θαδωρής Κανδηλιώτης	124	6959 997 120	—	—
Γιάννης Μαγγίνας	124	6945 934 803	—	—
Κώστας Καρίτζης	124	—	—	—

ΤΕΧΝΙΚΗ ΥΠΟΣΤΗΡΙΞΗ

Αυγέρης Αυγερινός	122	6946 904 598	service.ath@eldico.gr	—
Πέτρος Γρηγοριάδης	122	6951 959 708	service.ath@eldico.gr	—

ΟΝΟΜΑΤΕΠΩΝΥΜΟ	ΕΣΩΤ.	ΚΙΝ. ΤΗΛ/ΝΟ	eMAIL	SKYPE NAME
ΛΟΓΙΣΤΗΡΙΟ				
Πάρης Ξένος	102	6949 956 704	xenos@eldico.gr	—

ΚΑΤΑΛΟΓΟΙ, ΗΛΕΚΤΡΟΝΙΚΕΣ ΣΕΛΙΔΕΣ

Δημήτρης Μανδελιάς	119	—	mandelias@eldico.gr	mandelias
Κώστας Σταυρόπουλος	103	—	gd@eldico.gr	live:fb11e1e3d478a5af
Θοδωρής Αράνης	113	—	gd@eldico.gr	live:.cid.8c174d92813f9be3

R&D, GDPR, IT, ISO, MARKETING

Γιώργος Α. Βεράνης	106	6942 260 670	veranis@eldico.gr	georgeveranis
--------------------	-----	--------------	-------------------	---------------

ΘΕΣΣΑΛΟΝΙΚΗ 2310 57 00 37

ΟΝΟΜΑΤΕΠΩΝΥΜΟ	ΕΣΩΤ.	ΚΙΝ. ΤΗΛ/ΝΟ	eMAIL	SKYPE NAME
---------------	-------	-------------	-------	------------

ΣΥΜΒΟΥΛΟΙ ΑΓΟΡΩΝ

Γιάννης Βαφειάδης	207	6974 142 224	vi@eldico.gr	john_vafiadis
-------------------	-----	--------------	--------------	---------------

ΤΗΛΕΦΩΝΙΚΗ ΕΞΥΠΗΡΕΤΗΣΗ

Χρήστος Γκογκάκης	208	6945 896 511	cg@eldico.gr	live:cg_1290
Μανώλης Σουρής	209	—	sales.the@eldico.gr	eldico.sales.the

ΑΠΟΘΗΚΗ

Λευτέρης Τσάμπουρας	210	6955 440 986	—	—
Γιάννης Τσιφτσής	210	—	—	—
Χαράλαμπος Κεσκινιδής	210	—	—	—
Μαρία Δελή	210	—	—	—

ΜΕΤΑΦΟΡΕΣ

Χρήστος Τζίμας	210	6956 036 266	—	—
----------------	-----	--------------	---	---

ΜΕΤΑΦΟΡΕΣ / ΤΕΧΝΙΚΗ ΥΠΟΣΤΗΡΙΞΗ

Βασίλης Χατζικαμάρης	215	6943 076 045	service.the@eldico.gr	eldico.service.the
----------------------	-----	--------------	-----------------------	--------------------

1978

Ιδρύεται, από τους Χ. Μουσταφέλλο και Μ. Πινακουλάκη, η ELDICO ΕΠΕ ως πρώτη εταιρεία χονδρικής πώλησης ειδών camping με έδρα το Νέο Ψυχικό. Τα αρχικά της είναι παράγωγα των λέξεων h**EL**lenic **D**istribution **C**ompany.



1989

Έτος ορόσημο για την ΕΛΔΙΚΟ. Μετακομίζει σε νέες μεγάλες αποθήκες 3.800m² στο Βοτανικό. Στο σημείο που βρίσκεται ως σήμερα.



1995

Δεύτερο έτος ορόσημο, κατά το οποίο το κτήριο περνά στην ιδιοκτησία της εταιρείας, ενώ παράλληλα η οικογένεια Μουσταφέλλου αγοράζει το μερίδιο του κ. Πινακουλάκη.



2008

Αλλάζει το λογιστικό και εμπορικό πρόγραμμα της εταιρείας σε ERP. Η εξυπηρέτηση και η παραγγελιοληψία γίνονται ακόμα πιο ευέλικτες. Παράλληλα αλλάζει και η οργανωτική δομή της ΕΛΔΙΚΟ ΣΠΟΡ ΑΕΕ.



45 Χρόνια Ιστορίας

Η ΕΛΔΙΚΟ ΣΠΟΡ ΜΟΝ. ΑΕΕ στο πέρασμα του χρόνου



1981

Η εταιρεία μεταφέρεται στα νέα μεγάλα γραφεία στους Αμπελόκηπους με τα νέα της ονόματα: NEW ELDICO ΕΠΕ & ELDICO CAMPING.



1990

Η γκάμα των προϊόντων μεγαλώνει σημαντικά. Προστίθενται αθλητικά και είδη θαλάσσης, παίρνοντας, πλέον, την ονομασία ΕΛΔΙΚΟ ΣΠΟΡ ΑΕΕ.



1998

Μια πολύ σημαντική στρατηγική πολιτική της εταιρείας πραγματοποιείται. Η ΕΛΔΙΚΟ ΣΠΟΡ ΑΕΕ εισέρχεται στον χώρο των οργάνων γυμναστικής.



2007

Εκπληρώνεται ένα μεγάλο όνειρο. Η ΕΛΔΙΚΟ ΣΠΟΡ ΑΕΕ επενδύει στη βόρεια Ελλάδα κατασκευάζοντας ένα κτήριο 3.200m² στην περιοχή της Σίνδου Θεσσαλονίκης. Οι ακόμα πιο έγκαιρες και οικονομικότερες αποστολές γίνονται πραγματικότητα.



2012

Πραγματοποιούνται νέες μεγάλες επενδύσεις σε στόλο και εξοπλισμό. Δημιουργείται το eldico-ric.gr για την άμεση αποστολή φωτογραφιών και προσπέκτους.



2019

Νέα επέκταση αποθηκευτικού χώρου στις εγκαταστάσεις της Θεσσαλονίκης δημιουργεί διαθέσιμο 4.000m², αυξάνοντας τον συνολικό αποθηκευτικό χώρο της εταιρίας πλέον των 8.000m².



2011

Η ΕΛΔΙΚΟ ΣΠΟΡ ΑΕΕ πιστοποιεί την ποιότητα των υπηρεσιών της, προσθέτοντας στα ήδη υπάρχοντα συμφωνητικά με την Ελληνική Εταιρεία Αξιοποίησης Ανακύκλωσης ΑΕ και την εταιρία Ανακύκλωσης Συσκευών ΑΕ, το Πρότυπο ISO 9001:2000.

2013

Δημιουργείται ο δικτυακός χώρος B2B που δίνει OnLine πληροφόρηση σε όλους τους συνεργάτες.

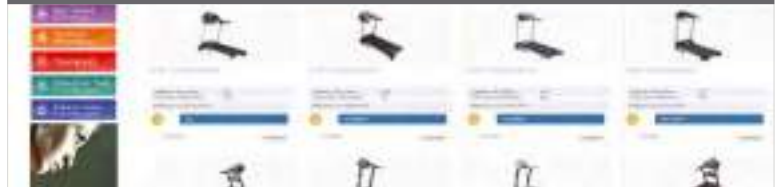

2020

Η εταιρία μετονομάζεται. Η νέα της επωνυμία είναι ΕΛΔΙΚΟ ΣΠΟΡ ΜΟΝΟΠΡΟΣΩΠΗ Α.Ε.Ε. Η οροφή του κεντρικού κτηρίου οικοδομείται, προσφέροντας επιπλέον προστασία στα προϊόντα. Παράλληλα διαμορφώνονται νέοι λειτουργικοί χώροι έκθεσης και συνομιλίας.



eldico-b2b.gr Η νέα on-line εποχή έφτασε!

Δεν πρόκειται για μια απλή on-line υπηρεσία. Η νέα πλατφόρμα της ΕΛΔΙΚΟ ΣΠΟΡ ΜΟΝ. ΑΕΕ σχεδιάστηκε από την αρχή, όχι για να προστεθεί απλά στις υπάρχουσες δομές αλλά για να αλλάξει εξολοκλήρου τον τρόπο με τον οποίο γινόντουσαν όλες οι ηλεκτρονικές συναλλαγές μέχρι σήμερα.

STAY TUNED!

Το 2020 ήταν η χρονιά μετάβασης στις νέες on-line B2B υπηρεσίες μας. Μια μόνο πλατφόρμα ενοποιεί πλέον οτιδήποτε μέχρι σήμερα υπάρχει σε ξεχωριστές σελίδες, σχεδιασμένη για να εξυπηρετεί κάθε ανάγκη με τον πιο λειτουργικό τρόπο. Μείνετε όμως συντονισμένοι: Η νέα B2C σελίδα καταφθάνει κι αυτή!



eldico-b2b.gr

Το 2013 δημιουργήσαμε την πρωτοποριακή διαδικτυακή υπηρεσία B2B (Business to Business) η οποία είναι συνδεδεμένη on-line με το εμπορικό πρόγραμμα της επιχείρησης προσφέροντας έγκυρη, άμεση και γρήγορη πληροφόρηση οποιαδήποτε στιγμή κι αν την χρειαστεί ο χρήστης.



Η πλατφόρμα B2B της ΕΛΔΙΚΟ έχει σχεδιαστεί έχοντας κατά νου τον πελάτη και τις σύγχρονες ανάγκες του.

Μέσα από την πλατφόρμα B2B ο χρήστης μπορεί να δει τα προϊόντα της ΕΛΔΙΚΟ, να ενημερωθεί για ό,τι νέο υπάρχει και όλα όσα αναμένονται σύντομα. Ταυτόχρονα υπάρχει η δυνατότητα να

ελέγξει **Best Sellers, Προϊόντα Φυλλοαδίου** με όσα περιέχονται στα τρέχοντα προωθητικά έντυπα που εκδίδονται από την εταιρεία. Στο B2B, επίσης, βρίσκονται διαθέσιμες οι **Προσφορές, τα Προϊόντα με Μειωμένες Τιμές και καρτέλες που περιέχουν είδη με μεταβλητή τιμή.** Η πλατφόρμα B2B είναι ένα «ζωντανό» cloud application το οποίο αναβαθμίζεται

και γίνεται καλύτερο μέρα με τη μέρα. Αυτό επιτυγχάνεται ακόμα γρηγορότερα εαν εσείς, οι συνεργάτες μας, μας στέλνετε feedback με απορίες, προτάσεις και παρατηρήσεις.



on-line οδηγός χρήσης:
eldico-b2b.gr/content/18-usage_manual

XML

Οι σύγχρονες ανάγκες για ακόμα πιο γρήγορη καταχώρηση δεδομένων, αλλά και για άμεση και αδιάκοπη ενημέρωση τιμών, διαθεσιμότητας (στις 2 αποθήκες ξεχωριστά), φωτογραφιών και 22 ακόμα στοιχείων, δημιούργησε την υπηρεσία XML.

Μην παραλείψετε να συγχρονίσετε το XML της ΕΛΔΙΚΟ ΣΠΟΡ ΜΟΝ. ΑΕΕ με το e-shop σας, για να έχετε την ταχύτερη και πιο έγκυρη πληροφόρηση όλων όσων σας ενδιαφέρουν. Το XML είναι πολύτιμος συνεργάτης και για όσους δεν διαθέτουν ηλεκτρονικό κατάστημα (e-shop). Οι πληροφορίες του μπορούν να σας χρησιμεύσουν σχεδόν σε όλες τις συναλλαγές σας. Απευθυνθείτε στον σύμβουλο αγορών που σας εξυπηρετεί και ζητήστε του το XML link σας.

Δείτε ένα σύντομο οδηγό της on-line υπηρεσίας στη διεύθυνση: eldico.gr/xml



AMILA.GR

OnLine Υπηρεσίες

XML: Το 2017 προσθέσαμε, στις ήδη υπάρχουσες ηλεκτρονικές υπηρεσίες (B2B, eldico-pic.gr, dropbox.k.ln), τη λίστα XML κάνοντας ακόμα πιο εύκολη την καταχώρηση δεδομένων.

eldico.gr: Σκοπός του ολοκαίνουριου κεντρικού site είναι η **σταδιακή εννοποίηση όλων των on-line υπηρεσιών** που σας παρέχουμε (καταλόγους, οδηγίων χρήσης, εικόνων, xml), έτσι ώστε να γίνει πιο φιλική η χρήση τους. Επιπλέον να προωθηθούν και κεντρικά (κοινωνικά δίκτυα, έντυπο και ηλεκτρονικό τύπο) τα προϊόντα που προσφέρετε και, έτσι, να διευκολύνουν τις πωλήσεις σας.





Κατάλογοι, προϊόντα, ενημερωμένες πληροφορίες και τιμές, απ' όπου κι αν βρίσκεστε, άμεσα κι απλά.

Dropbox: Η νέα μας on-line υπηρεσία ενημέρωσης

Η ΕΛΔΙΚΟ ΣΠΟΡ ΜΟΝ. ΑΕΕ στην προσπάθειά της να γίνει όσο το δυνατόν πιο φιλική και άμεση στις ανάγκες σας, εισήγαγε την υπηρεσία Dropbox στις on-line παροχές της, προσφέροντας κάθε στιγμή, όπου κι αν βρίσκεστε, **την πιο ενημερωμένη έκδοση των καταλόγων της**.

Έτσι, όταν χρειάζεται να ανατρέξετε σε προϊόντα και τιμές, με το Dropbox μπορείτε να έχετε έγκυρη πληροφόρηση, από τον υπολογιστή ή το κινητό σας, **με ένα μόνο click**.

Τι είναι το Dropbox;

Το Dropbox είναι μια δωρεάν on-line υπηρεσία αποθηκευτικού χώρου που επιτρέπει την κοινή χρήση αρχείων μεταξύ διαφορετικών συσκευών και χρηστών. Με απλά λόγια είναι **ένας σκληρός δίσκος στο internet**.



Γιατί όμως να χρησιμοποιήσω το Dropbox;

Ο κυριότερος λόγος είναι η **αμεσότητα**. Ενημερώνεται αυτόματα και προσφέρει, όποτε το χρειαστείτε, πολύ γρήγορα, με ελάχιστες απαιτήσεις, σε οποιαδήποτε συσκευή σας, **την πιο ενημερωμένη έκδοση όλων των καταλόγων μας**.

Φανταστείτε ότι βρίσκεστε στο κατάστημα σας και δεν μπορείτε να βρείτε που έχετε αφήσει τον κατάλογο της ΕΛΔΙΚΟ ΣΠΟΡ ΜΟΝ. ΑΕΕ ή σε κάποιο ραντεβού για δειγματισμό ή ακόμα και στον δρόμο ή το σπίτι και θέλετε να σημειώσετε κάποια από τα προϊόντα ή να ελέγξετε την τρέχουσα τιμή τους.

Χωρίς να χρειάζεται να κάνετε κάποια άλλη ενέργεια, ανοίγοντας απλά τον υπολογιστή ή το κινητό σας, έχετε τα ίδια ακριβώς αρχεία με αυτά που έχουμε κι εμείς.

Εγκαταστήστε τώρα την υπηρεσία Dropbox και μείνετε ενημερωμένοι για πάντα.

Επικοινωνήστε με την ΕΛΔΙΚΟ ΣΠΟΡ ΜΟΝΟΠΡΟΣΩΠΗ ΑΕΕ και ένας συνεργάτης μας θα βρίσκεται πάντοτε διαθέσιμος για να σας βοηθήσει στην δημιουργία του λογαριασμού σας, με απλές οδηγίες και επεξηγηματικά videos.



Συμβατότητα

Είναι συμβατό με υπολογιστές που χρησιμοποιούν windows, linux ή και MAC, με κινητά τηλέφωνα iPhone, Android, BlackBerry και ταμπλέτες.

Εκμεταλλευτείτε τις δυνατότητες του solefitness.gr και βοηθήστε τους πελάτες σας να δουν όλα τα προϊόντα SOLE και να λύσουν τις απορίες τους.



▲ ανακαλύψτε τα προϊόντα της SOLE μέσα από τα videos στο solefitness.gr/support

Σκοπός του solefitness.gr είναι να βοηθήσει στην κατά το δυνατόν μεγαλύτερη και πιο αναλυτική εξερεύνηση των εξαιρετικών Ποδημάτων και Ελληιπτικών της SOLE και των δυνατοτήτων που παρέχουν στους χρήστες τους.

Η σελίδα χωρίζεται σε πέντε (5) βασικά μέρη πλοήγησης:

- α Σχετικά με τη SOLE**
Σύντομη παρουσίαση της εταιρίας SOLE Fitness.
- β Προϊόντα**
Επιλέγοντας "Διάδρομοι" ή "Ελληιπτικά" ανακαλύψτε κάθε πτυχή των κορυφαίων οργάνων της SOLE.
- γ SOLE Fitness App**
Μάθε τις απεριόριστες δυνατότητες που σου προσφέρονται συνδέοντας την iOS ή Android συσκευή σου στον αγαπημένο σου SOLE.
- δ Υποστήριξη**
Αναλυτικά videos παρουσιάσεων και εγχειριδίων χρήσης για όλα τα προϊόντα SOLE Fitness.
- ε Συνεργάτες**
Το Δίκτυο Συνεργατών αποτελεί το σημαντικότερο κρίκο μιας άψογης εμπειρίας.

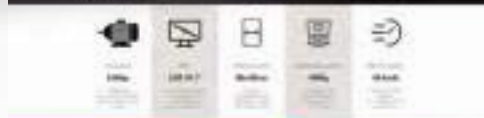

SOLE

Δημιουργούμε τα κατάλληλα εργαλεία για την προώθηση των πωλήσεών σας.



Εγχειρίδια Χρήσης

Δεν χρειάζεται να ψάχνεις. Όλα τα εγχειρίδια χρήσης των διαδρόμων και των ελληιπτικών της SOLE Fitness βρίσκονται πλέον συγκεντρωμένα και διαθέσιμα όποτε κι αν τα χρειαστείς.

Τιμές Λιανικής

Στην αρχή κάθε παρουσίασης αναγράφεται η προτεινόμενη λιανική τιμή.

footer

◀ Μην ξεχάσεις να ρίξεις μια ματιά στα χαρακτηριστικά!



Αναγνωρισιμότητα, Ανταπόκριση, Παρουσίαση, Προώθηση, Πώληση!

Ψηφιακό Κανάλι: eldico.gr/youtube

Η ΕΛΔΙΚΟ ΣΠΟΡ ΜΟΝ. ΑΕΕ ανταποκρινόμενη στις συνεχώς αυξανόμενες ανάγκες ενός σύγχρονου επιχειρηματικού περιβάλλοντος, βελτιώνει διαρκώς τις υπηρεσίες της, εκπέμποντας μέσα από το δικό της **κανάλι** στο eldico.gr/youtube

Αυξήστε τις πωλήσεις σας με Video Marketing

Το YouTube δημιουργήθηκε το 2005. Ένα μόλις χρόνο μετά ονομάστηκε "η εφεύρεση της χρονιάς" από το περιοδικό Times. Σύμφωνα με την Έρευνα Κοινωνικής Δικτύωσης 2013-14 του Οικονομικού Πανεπιστημίου Αθηνών και του ELTRUN το **YouTube είναι πρώτο από όλα τα Social Media. Οι επιχειρήσεις βρίσκουν συνεχώς ολοένα και περισσότερους τρόπους για να χρησιμοποιήσουν τα videos ώστε να προσεγγίσουν τους πελάτες τους.**

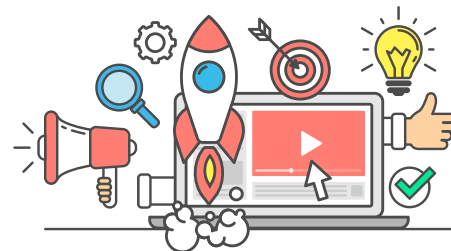

Το Video Marketing με αριθμούς

Σύμφωνα με έρευνα του Ascend2 (Research-Based Marketing) για το 2015, **τα videos αυξάνουν:**
κατά 47% την αναγνωρισιμότητα (brand awareness)
κατά 45% τη αλληλεπίδραση των ακολούθων σας (engagement)
κατά 43% την ενημέρωση των πελατών
κατά 41% τις ενέργειες
κατά 34% το ποσοστό ανταπόκρισης (conversion rate)
κατά 26% τα έσοδα από πωλήσεις

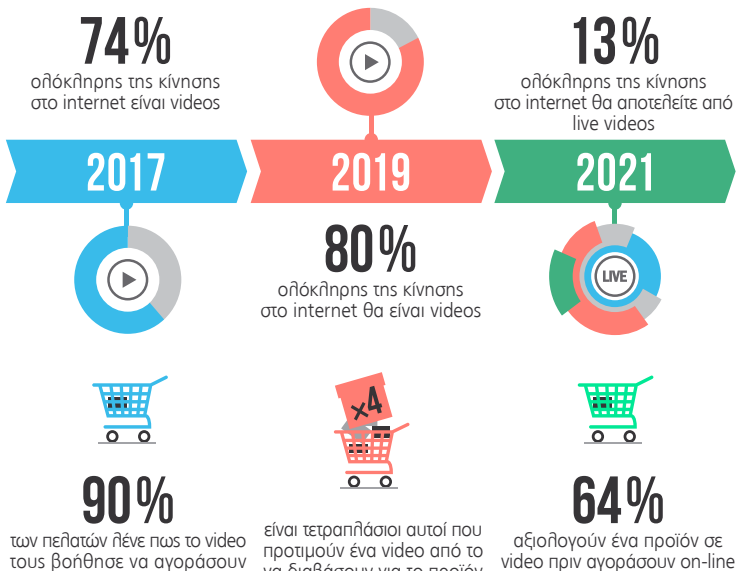
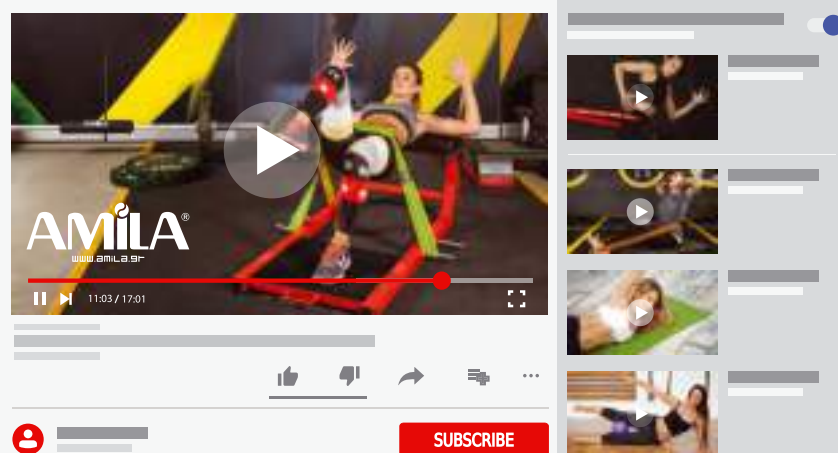

Τι περιμένεις; Ξεκίνησε Τώρα!

Το 85% των εταιρειών δηλώνει ότι το video marketing είχε επιτυχία για την επιχείρησή τους.

Εμπλουτίστε τη σελίδα ή το eShop σας με τα videos από το κανάλι της ΕΛΔΙΚΟ και βοηθήστε τις πωλήσεις σας όσο τίποτε.

Για να **μπείτε** στο κανάλι της ΕΛΔΙΚΟ ΣΠΟΡ ΜΟΝ. ΑΕΕ, πληκτρολογήστε στη γραμμή διεύθυνσεων: eldico.gr/youtube

Για να διαλέξετε **συγκεκριμένο φάκελο με videos** επιλέξτε από το menu το "PLAYLISTS".

Μην ξεχάσεις να κάνεις **SUBSCRIBE (ΕΓΓΡΑΦΗ)** στο κανάλι **ELDICO SPORT SA** για να μαθαίνεις πρώτος τα νέα videos και να τα προωθείς, μέσω των δικών σου καναλιών ή του eShop σου, **αυξάνοντας τις πωλήσεις σου!**

eldico.gr/youtube



Διάδρομος

Όλα όσα θα πρέπει να ξέρεις για τον κατασκευαστή και την χώρα παραγωγής

Ένας από τους πλέον σημαντικούς παράγοντες για την ποιότητα ενός διαδρόμου είναι ο κατασκευαστής [εργοστάσιο κατασκευής] αλλά και η χώρα κατασκευής.

Το μεγαλύτερο ποσοστό των διαδρόμων κατασκευάζεται σε δυο χώρες: την Ταϊβάν και την Κίνα.

Τα εργοστάσια κατασκευής χωρίζονται σε τέσσερις [4] κύριες κατηγορίες, με την ακόλουθη κατάταξη ως προς την ποιότητα κατασκευής:

1. Εργοστάσια στην Ταϊβάν.
2. Ταϊβανέζοι κατασκευαστές με εργοστάσιο συναρμολόγησης στην Κίνα.
3. Μεγάλοι Κινέζοι κατασκευαστές με εμπειρία και συνεργασία με μεγάλους οίκους.
4. Λοιποί Κινέζοι κατασκευαστές.

Treadmill Doctor
The Most Trusted Name In
Fitness Equipment

Οι διάδρομοι της **AMILA** κατασκευάζονται σε 3 Ταϊβανέζικα εργοστάσια που παράγουν για μεγάλους και επώνυμους οίκους της Αμερικής και της Ευρώπης, των οποίων τα προϊόντα είναι ανάμεσα στις καλύτερες επιλογές, σύμφωνα με τις λίστες Αμερικανικών οίκων αξιολόγησης (Dr. Treadmill κλπ).

Ορισμένοι ενδιάμεσοι διάδρομοι AMILA και όλοι οι οικονομικοί, κατασκευάζονται στα εργοστάσια των Ταϊβανέζων κατασκευαστών που βρίσκονται στην Κίνα.

Η **ΕΛΛΔΙΚΟ ΣΠΟΡ ΑΕ** πιστεύει ότι παρόλο που οι Κινέζοι κατασκευαστές έχουν βελτιωθεί τα τελευταία χρόνια, ωστόσο εξακολουθούν τα προϊόντα και οι υπηρεσίες τους να υπολείπονται σημαντικά από αυτά των Ταϊβανέζων κατασκευαστών.

Πόση σημασία έχει η ιπποδύναμη του μοτέρ σε ένα διάδρομο;

Το κόστος ενός μοτέρ μεγαλύτερης ιπποδύναμης είναι συγκριτικά μικρό ενώ το κόστος του επιπλέον βάρους, της βελτίωσης στην ακαμψία του διαδρόμου και της μεγαλύτερης άνεσης είναι πολλαπλάσιο.

Το κόστος για τον κατασκευαστή προκύπτει από τη διαπλάτυνση και το βάρος του διαδρόμου, και όχι από την ιπποδύναμη.

Μεγαλώνοντας το πλάτος ενός διαδρόμου, μεγαλώνει αναλογικά το μήκος, ο ιμάντας, τα ρουλά και μεγαλώνει η κοσδόλα που πλέον έχει πολύ περισσότερες λειτουργίες.

Ποια η διαφορά των μοτέρ AC με τα DC;

Η διαφορά βρίσκεται στην πηγή τροφοδοσίας τους.

Τα μοτέρ AC τροφοδοτούνται με εναλλασσόμενο ρεύμα που ελέγχεται από ηλεκτρονικό κύκλωμα και πρόγραμμα (inverter).

Τα μοτέρ DC τροφοδοτούνται με συνεχές ρεύμα ελεγχόμενο από ένα ηλεκτρονικό κύκλωμα μετατροπής του εναλλασσόμενου ρεύματος σε συνεχές.

Τα μοτέρ AC είναι πιο δυνατά, έχουν πολύ μεγαλύτερη διάρκεια ζωής και θέλουν πολύ λιγότερη συντήρηση, είναι όμως πιο ακριβά και σε συνδυασμό με τον inverter που χρησιμοποιούν το κόστος τους είναι αυξημένο.



Ιμάντας Τρεξίματος Το μέγεθος μετράει!

Στην Αμερική αλλά και στην Ευρώπη οι διάδρομοι πουλιούνται πλέον ΟΧΙ με βάση την Ιπποδύναμη του μοτέρ, αλλά με βάση την διάσταση του ιμάντα τρεξίματος.

Μέτρηση Ιπποδύναμης

Το μοτέρ είναι αρκετά σημαντικός παράγοντας, οφείλουμε όμως να είμαστε προσεκτικοί. Υπάρχει πολύ παραπληροφόρηση όσο αφορά την ιπποδύναμη του.

Λόγω της ιδιαιτερότητας του διαδρόμου (απαιτεί από το μοτέρ πλήρη ισχύ μόνο για ορισμένα

μόνο κλάσματα του δευτερολέπτου) η ιπποδύναμη μετριέται με πολλούς τρόπους. Έτσι έχουμε δύο τύπους ιπποδύναμης, την συνεχή και την στιγμιαία αποδιδόμενη.

Πολλοί κατασκευαστές, εκμεταλλεύονται αυτή τη σύγχυση, αναφέρουν σκόπιμα μόνο τη μέγιστη στιγμιαία ισχύ.

Ιπποδύναμη και Ιμάντας

Στο εμπρός μέρος του διαδρόμου βρίσκεται το μοτέρ, ο μηχανισμός ανύψωσης και ο ελεγκτής (controller).

Ο χώρος, πολλές φορές είναι δεσμευτικός του μεγέθους του μοτέρ. Για ένα μοτέρ 2Hp το ελάχιστο πλάτος του ιμάντα είναι 45cm. Εάν ο ιμάντας είναι στενότερος των 45cm, το πιο πιθανόν είναι η ιπποδύναμη του μοτέρ να είναι μικρότερη από 2Hp.

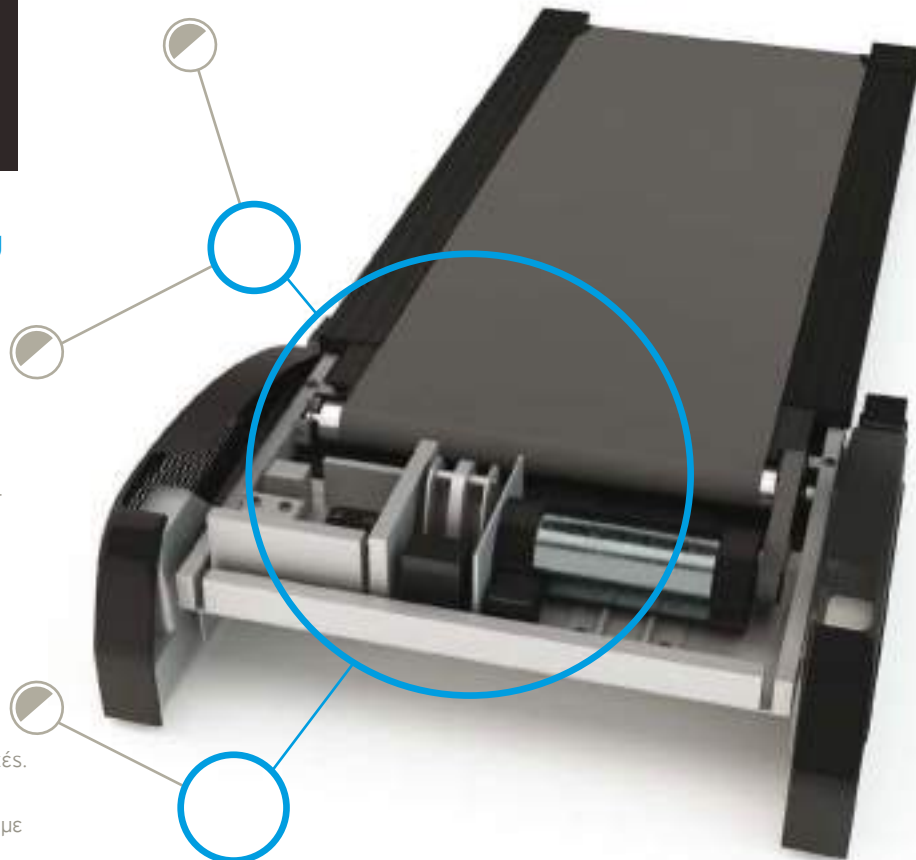

Ιμάντας Τρεξίματος

Όσο πιο παχύς είναι ο ιμάντας τόσο πιο ανθεκτικός και άνετος (αντικραδασμικός) γίνεται

Τα συνήθη πάχη του είναι: 1.6 -2.5mm και 3.0mm ο ορθοπεδικός.

Όλοι οι ιμάντες της AMILA, παρέχουν αντιστατική προστασία, και διοχετεύουν το στατικό ηλεκτρισμό στην γείωση, ώστε να προστατεύονται τα ηλεκτρονικά μέρη του διαδρόμου.

Τελευταία οι εταιρείες αυξάνουν τον ιμάντα τρεξίματος με πλασματικό τρόπο χωρίς να αυξήσουν το πλάτος του διαδρόμου. Η αύξηση αυτή γίνεται καταλαμβάνοντας το κενό που υπήρχε παλαιότερα μεταξύ του ιμάντα και των πλαισίων κουπαστών.

Έτσι ένας ιμάντας που παλαιότερα ήταν 43cm, τώρα μπορεί να φτάσει τα 45cm μειώνοντας μόνο τα κενά.

Κύλινδροι

Όσο μεγαλύτεροι είναι οι κύλινδροι τόσο περισσότερο βοηθούν το μοτέρ να ανταποκριθεί στις καταπονήσεις. Το μέγεθος των κυλίνδρων ποικίλει. Μπορούμε να τους συναντήσουμε από 48 μέχρι 100mm.

Κυλίνδρους 48mm βρίσκουμε σε μικρούς διαδρόμους 1.25-1.50hr ενώ των 60mm συναντούμε συνήθως σε μοτέρ 2.5hr και άνω.

Το μέγεθος των 100mm χρησιμοποιείται για διαδρόμους επαγγελματικής χρήσης.

Δάπεδο διαδρόμου

Εξίσου σημαντικός ποιοτικός παράγων είναι ο κατάλληλος συνδυασμός δαπέδου, και ιμάντα τρεξίματος, ώστε να έχουμε μικρότερη τριβή, μικρότερη θερμοκρασία, και μικρότερη καταπόνηση του μοτέρ.



Κονσόλα

Τα κύρια σημεία που πρέπει να ελέγξουμε σε μια κονσόλα είναι:

- Κουμπιά κλίσης και ταχύτητας στις χειρολαβές
- Μεγάλη οθόνη πολλαπλών ενδείξεων για άμεση ενημέρωση των παραμέτρων της άσκησης
- Μπλε οθόνη για ομορφιά, αλλά και για άνετη ανάγνωση των παραμέτρων της άσκησης
- Προγράμματα. Πρακτικώς είναι το λιγότερο αναγκαίο χαρακτηριστικό.
- Δέκτη καρδιακών παλμών για να μπορεί να δεχθεί ζώνη καρδιακών παλμών.
- Χειρολαβές αισθητήρων καρδιακών παλμών με εργονομική κλίση.
- Κουπαστές από ειδικά υλικά που να μπορούν να παρέχουν προστασία.

* τέσσερις πρόχειροι και απλοί μέθοδοι σύγκρισης της ποιότητας των μοτέρ

1. : Μετρώντας το καθαρό μήκος του μοτέρ
2. : Μετρώντας το βάρος του μοτέρ
3. : Ζυγίζοντας ή ρωτώντας το καθαρό βάρος του διαδρόμου

Το σημαντικότερο στοιχείο είναι το πλάτος του ιμάντα τρεξίματος.

Ένας διάδρομος 2hr θα πρέπει να έχει τουλάχιστον 45cm ιμάντα, αναγκαία συνθήκη αλλά όχι και ικανή (θα μπορούσε δηλαδή να υπάρξει ιμάντας 50cm για παράδειγμα με μοτέρ μικρότερο των 2hr).

Βάρος διαδρόμου	Maximum βάρος αναβάτη	Ιπποδύναμη	"Min. Size Ιμάντα τρεξίματος"	Βάρος Μοτέρ [Kg]	Μήκος Μοτέρ [cm]
60	90 - 100	1,25 - 1,50	40 cm	6,80	23,5
67 - 67	100	1,50 - 1,75	40 cm	7,97	21,5
75 - 78	100	1,75	42 cm	11,13	26,5
82	110	2,00	45 cm	11,80	25,0
92	120	2,00 - 2,50	48 cm	12,66	27,0
105	130	3,00	50 cm	14,05	28,5

Πίνακας βαρών και διαστάσεων μοτέρ.



Cushion Flex Whisper Deck

The deck of the **SOLE** treadmills provides a comfortable and quiet workout.

The correct combination of anti-vibration materials, deck and belt has proven according to a study to **reduce noise and foot vibration/impact by 40%** compared to running on asphalt.

Thus the user is protected in the best possible way..

SOLE
FITNESS



Easy to fold/unfold and transport

SOLE Fitness has improved the way it folds/unfolds its treadmill's deck. It will slowly unfold at the push of a switch Με το πάτημα ενός διακόπτη θα ξεδιπλωθεί αργά, without needing any help and will fold **securely** and **easily** into an upright position. The integrated wheels at the bottom makes its transport a childs play.



Treadmill Doctor
The Most Trusted Name in Fitness Equipment

Doctor Treadmill's BEST BUY

SOLE Fitness has won dozens of awards.

All its models are always in the top 3 of the most review sites.

But its biggest success is that its **F80 model, for the last 4 years, has been in the list of the 3 best treadmills in the US market** from the most prominent treadmill review website, **Doctor Treadmill**.

Out of those 4 years, for 2 in the row it was the number 1 on the list.

Its elliptical, E35, according to **Doctor Treadmill** and other review websites, is characterised as **the best elliptical in the largest and most competitive category** of a price range between \$1.000-1.300.

Increase your sales by integrating the SOLE Fitness videos into your eShop



Double Horseshole Folding Frame

The treadmills by **SOLE Fitness** are designed to be folded and easily transported, without lacking anything at all from the robustness of the non-folding ones.

The frame is constructed entirely of **heavy-duty** steel, welded in such a way as to **not have any rattles and noises**, while at the same time making it easy to use.



The irrefutable quality of **SOLE** was the reason it was **selected by HILTON to equip all of its suites and Luxury Business Rooms worldwide** with its treadmills. **SOLE** further developed its technology so that anyone (even a woman) can fold, unfold and move the treadmill, an advantage which was deemed necessary for the ease of cleaning the room. After that, **SOLE** was chosen by many more hotels πηλέχτηκε to equip their suites.

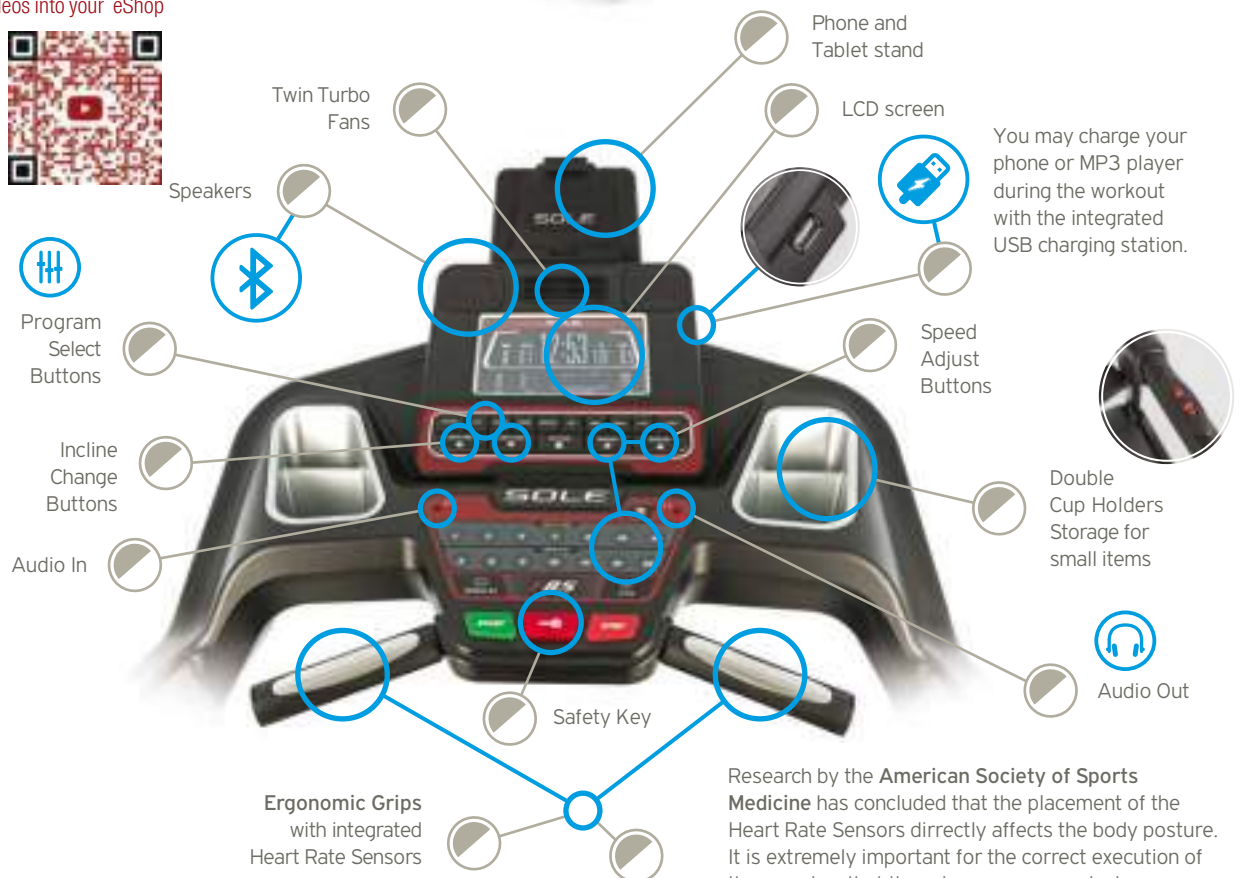

Research by the **American Society of Sports Medicine** has concluded that the placement of the Heart Rate Sensors directly affects the body posture. It is extremely important for the correct execution of the exercise that the grips are ergonomical.

Adjustable Pedals

SOLE Fitness, taking into account that not all users walk the same way, in addition to the fact that the best exercise is achieved when the sole move parallel to the ground. For these reasons, it enabled the user to adjust the incline of the pedals up to 10° degrees.



<http://solefitness.gr>

SOLE

For many years, SOLE Fitness, an American company designing and manufacturing fitness equipment, has proven to be one of the basic protagonists in the fitness equipment market, both for beginners and the very advanced users. SOLE continues unabated to design and develop fitness equipment for home and semi-commercial use for small gyms and hotels.

Electronic Incline

The electronic incline provides **extra resistance** and **variable positioning** to your workout at the touch of a button.

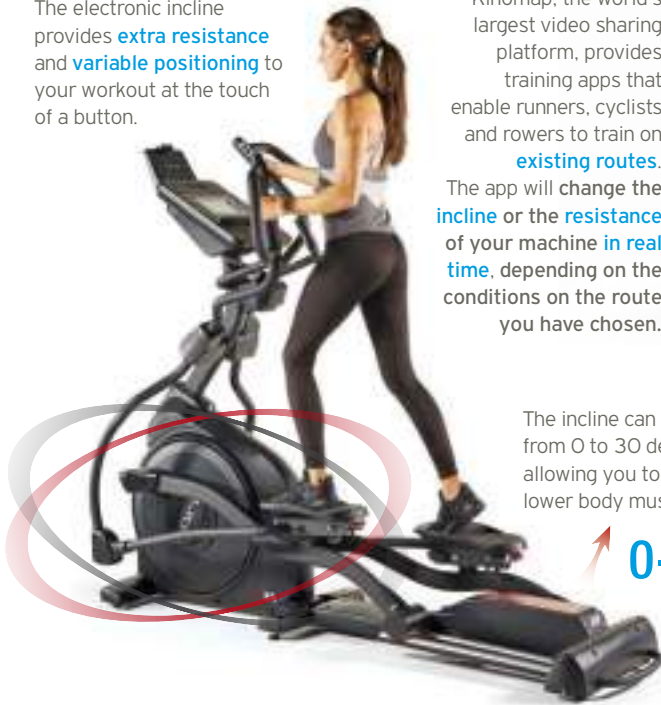

The incline can be adjusted from 0 to 30 degrees, allowing you to exercise all lower body muscle groups.

0-30°

Kinomap

Kinomap, the world's largest video sharing platform, provides training apps that enable runners, cyclists and rowers to train on **existing routes**. The app will change the **incline** or the **resistance** of your machine **in real time**, depending on the conditions on the route you have chosen.



SOLE Fitness APP

The **SOLE Fitness APP** connects to the treadmill, bike or elliptical by **Bluetooth**.

You may see the current exercise data on 3 distinct screens on your **Android** or **Apple** device.

Upon completion of the exercise, the data is automatically saved in your personal diary.



2° Internal Slope

According to research, the exercise on the elliptical becomes more ergonomic (more comfortable, efficient and safer from ankle injuries) when the incline of the sole is 2° inwards, which inclination **aligns more correctly the legs to the body** and **reduces the pressure on the ankles and knees**.



You can charge your phone or MP3 player while exercising with the built-in USB charging port.



Warranty & Quality

All **SOLE Fitness** products are made in a simple way, emphasising

- the high-quality materials and components,
- the perfect combination of design and technology [e.g. not only quality of materials and the combination of running belt with the deck, as well as the size and quality of

the rollers to be able to cope with the demanding hotel environment] but mainly

- at competitive—in relation to their quality— prices.

SOLE Fitness backs all its parts—electrical and mechanical—with a 2 year warranty. Specifically for the motor, the warranty is extended to 10 years.



F85 (2019)

Category D1

44819



F80 (2023)

Category D1

44807



Motor	4.00 hp	3.50 hp (7.00 hp peak)
Console	LCD 10.1", Speed and Incline buttons, Program select buttons, Heart rate sensors	TFT 10.1" Touchscreen with WiFi, various applications and smartphone mirroring function, Speed and Incline buttons, Heart rate sensors
Console Readings	Time, Distance, Calories, Speed, Heart rate, Incline, Pace	Time, Distance, Heart rate, Calories, Speed, Incline, Pace, Track
Programs	5 + 1 manual + 2 HRC + 2 user	7 + 2 HRC + 7 fitness tests + up to 12 user
Speed	1-22 Km/h	1-20 Km/h
Incline	Electronic 0%-15%	Electronic 15 levels
Deck	—	Cushion Flex Whisper Deck
Belt	56x153 cm	56x152,5 cm
Rollers	—	—
Dimensions (open)	208x93x168cm	209,5x96x167,5cm (folded 112x96x181,5cm)
Weight	127Kg	124,5Kg
Max User Weight	150 Kg	160 Kg
Other Specs	Transport wheels, Bottle holder, Fans, Phone/tablet holder, Headphone jack, Speakers, Line-in, Bluetooth speaker, Bluetooth hear rate monitor, USB charging, Heart rate receiver, SOLE APP	Fan, Phone/tablet holder, Bottle holder, 10 watt wireless charging, Accessory tray, Speakers via Bluetooth 3, Polar, SOLE+, Kinomap, Zwift apps via Bluetooth 5, WiFi

USAGE WITH PHONE

- + Bluetooth
- + SOLE app.
- + Data sync with Nike+, Fitbit, Health, Record, MapMyFitness, MyFitnessPal

USAGE WITH PHONE

- + Bluetooth
- + SOLE+ app.
- + Data sync with Apple Health, Google Fit, Strava, Fitbit, MapMyFitness
- + Data sharing with Facebook, Instagram, Twitter



+ Speed & Incline buttons on the hand-grips

WARRANTY
1 year for commercial use



+ Speed & Incline buttons on the hand-grips

WARRANTY
1 year for commercial use



F65 (2023)

Category D1

44806
\$ 924,00



F63 (2023)

Category D1

44805



Motor	3.00 hp (6.00 hp peak)	3.00 hp (6.00 hp peak)
Console	LCD 9", Speed and Incline buttons, Heart rate sensors	LCD 6.5", Speed and Incline buttons, Heart rate sensors
Console Readings	Time, Distance, Heart rate, Calories, Speed, Incline, Pace, Track	Time, Distance, Heart rate, Calories, Speed, Incline, Pace, Track
Programs	5 + 2 HRC + 2 user	5 + 2 HRC + 2 user
Speed	1-20 Km/h	1-20 Km/h
Incline	Electronic 15 levels	Electronic 15 levels
Deck	Cushion Flex Whisper Deck	Cushion Flex Whisper Deck
Belt	56x152,5 cm	51x152,5 cm
Rollers	—	—
Dimensions (open)	208,4x96x170cm (folded 108x96x183,5cm)	196x88,5x169,5cm (folded 128,88,5x168,5cm)
Weight	121Kg	102Kg
Max User Weight	150 Kg	150 Kg
Other Specs	Fan, Phone/tablet holder, Bottle holder, USB port for charging, Accessory tray, Speakers via Bluetooth 3, Polar, SOLE+, Kinomap, Zwift apps via Bluetooth 5	Fan, Phone/tablet holder, Bottle holder, USB port for charging, Accessory tray, Speakers via Bluetooth 3, Polar, SOLE+, Kinomap, Zwift apps via Bluetooth 5



USAGE WITH PHONE

- + Bluetooth
- + SOLE+ app.
- + Data sync with Apple Health, Google Fit, Strava, Fitbit, MapMyFitness
- + Data sharing with Facebook, Instagram, Twitter



USAGE WITH PHONE

- + Bluetooth
- + SOLE+ app.
- + Data sync with Apple Health, Google Fit, Strava, Fitbit, MapMyFitness
- + Data sharing with Facebook, Instagram, Twitter

+ Speed & Incline buttons on the hand-grips

WARRANTY
1 year for commercial use



+ Speed & Incline buttons on the hand-grips

WARRANTY
1 year for commercial use



F63 (ST100)

Category D1

44827



Progressive F350PI

92219

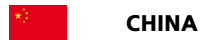

Motor	3.00 hp (6.00 hp peak)	3.50 hp
Console	LCD 6.5", Speed and Incline buttons, Heart rate sensors	LCD Blue 7", Speed and Incline buttons, Heart rate sensors
Console Readings	Time, Distance, Heart rate, Calories, Speed, Incline	Time, Speed, Distance, Incline, Calories, Heart rate, Body fat
Programs	5 + 2 HRC + 2 user	80 + manual + 5 user
Speed	1-18 Km/h	1-22 Km/h
Incline	Electronic 15 levels	Electronic 20%
Deck	Anti-shock 18mm, 146x71 cm, melamin, one side covered with resin, the other with PVC	18mm thick
Belt	51x153 cm, 2 layers, 1.6mm thick	54x150 cm, 1.4mm thick
Rollers	Front 60mm, Rear 60mm	Front 56mm, Rear 48mm
Dimensions (open)	209x89x146cm	201x86x143 cm
Weight	115Kg	95Kg
Max User Weight	150 Kg	160 Kg
Other Specs	Fan, Bottle holder, Headphone jack, Speakers, Polar, SOLE APP	Transport wheels, Hydraulic assistance when folding/unfolding, Bottle holder, Speakers, USB, MP3, Book/tablet stand, APK

USAGE WITH PHONE

- + Bluetooth
- + SOLE app.
- + Data sync with Nike+, Fitbit, Health, Record, MapMyFitness, MyFitnessPal



+ Speed & Incline buttons on the hand-grips

WARRANTY
1 year for commercial use

+ Speed & Incline buttons on the hand-grips



Velos NF400PI

Category D1

92232



KINA

Valma AC250PI

Category D1

92220



CHINA

Motor	4.00 hp DC Brushless (8.00 hp peak)	2.50 hp AC
Console	LED, 7 παράθυρα	LCD Blue 7", Speed and Incline buttons, Heart rate sensors
Console Readings	Time, Distance, Heart rate, Calories, Speed, Incline, Body fat	Time, Distance, Heart rate, Calories, Speed, Incline, Body Fat
Programs	36 + manual	24 + manual
Speed	1-22Km/h	1-24 Km/h
Incline	Electronic 15%	Electronic 20%
Deck	Anti-shock 21mm	Anti-shock 18mm
Belt	55x147 cm, 2.0mm thick	58x150 cm, 1.6mm thick
Rollers	—	Front 70mm, Rear 60mm
Dimensions (open)	185x82x154 cm	205x84x142 cm
Weight	125Kg	106Kg
Max User Weight	150 Kg	180 Kg
Other Specs	Transport wheels, Bottle holder, Speakers, Phone/tablet stand, MP3	Transport wheels, Speakers, Fan, USB, MP3



USAGE WITH PHONE

- + Bluetooth
- + Compatible APKs: Kinomap, Zwift, AnyRun



+ Speed & Incline buttons on the hand-grips

Semi-Commercial Grade

NON-FOLDING



+ Speed & Incline buttons on the hand-grips

Semi-Commercial Grade

NON-FOLDING



Eolos F300PI

Category D1

92223



CHINA

Hermes F275PI

Category D1

92218



CHINA

Motor	3.00 hp (6.00 hp peak)	2.75 hp
Console	LED, 4 windows	LCD Blue 7", Speed and Incline buttons, Heart rate sensors
Console Readings	Time, Speed, Distance, Incline, Calories, Heart rate, Body fat	Time, Speed, Distance, Incline, Calories, Heart rate, Body fat
Programs	60 + manual + 5 user + body fat	15 + manual
Speed	1-20 Km/h	1-18 Km/h
Incline	Electronic 18%	Electronic 18%
Deck	15mm thick	15mm thick
Belt	48x140 cm, 1.6mm thick	48x138 cm, 1.6mm thick
Rollers	Front 46mm, Rear 42mm	Front 48mm, Rear 42mm
Dimensions (open)	199x83x133 cm	191x80x140 cm
Weight	70Kg	85Kg
Max User Weight	130 Kg	130 Kg
Other Specs	Transport wheels, Hydraulic assistance when folding/unfolding, Bottle holder, Speakers, Bluetooth, MP3, Book/tablet stand, APK	Transport wheels, Hydraulic assistance when folding/unfolding, Bottle holder, Line-in, MP3, USB, Speakers, APK



USAGE WITH PHONE

- + Bluetooth
- + Compatible APKs: Kinomap, Zwift, FitShow



+ Speed & Incline buttons on the hand-grips



+ Speed & Incline buttons on the hand-grips

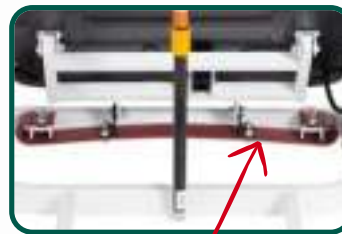

Anti-shock suspension under the front side of the deck



Velos F200PI

Category D1

92230



KINA

Velos F300PI

Category D1

92231



CHINA

Motor	2.00 hp DC (4.00 hp peak)	3.00 hp (6.00 hp peak)
Console	3 LED windows	3 LED windows
Console Readings	Time, Distance, Heart rate, Calories, Speed, Incline, Body fat	Time, Distance, Heart rate, Calories, Speed, Incline, Body fat
Programs	36 + manual	36 + manual
Speed	1-16Km/h	1-20 Km/h
Incline	Electronic 12%	Electronic 15%
Deck	Anti-shock 15mm	Anti-shock 18mm
Belt	42x125 cm, 1.4mm thick	50x142 cm, 1.6mm thick
Rollers	Front 42mm, Rear 42mm	Front 55mm, Rear 50mm
Dimensions (open)	153,5x67,5x142 cm	171x81,5x143 cm
Weight	59Kg	79,5Kg
Max User Weight	120 Kg	130 Kg
Other Specs	Transport wheels, Bottle holder, Speakers, Phone/tablet stand, MP3	Transport wheels, Bottle holder, Speakers, Phone/tablet stand, MP3



USAGE WITH PHONE

- + Bluetooth
- + Compatible APKs: Kinomap, Zwift, AnyRun



USAGE WITH PHONE

- + Bluetooth
- + Compatible APKs: Kinomap, Zwift, AnyRun



+ Speed & Incline buttons on the hand-grips

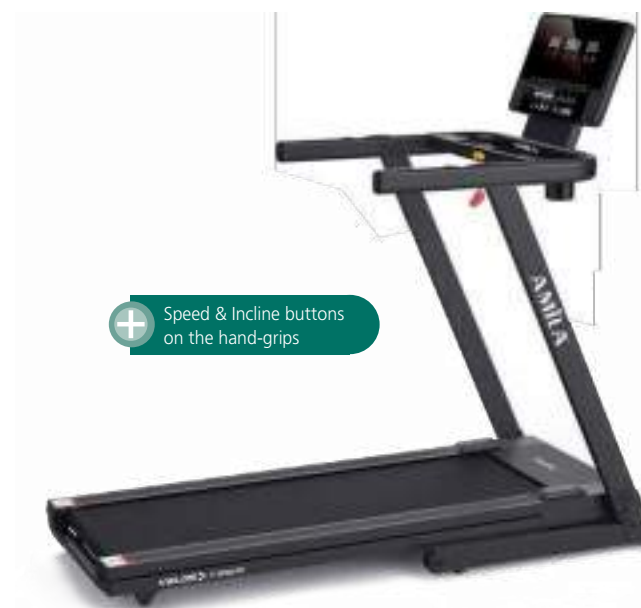

+ Speed & Incline buttons on the hand-grips



Valma S F200PI

Category D1

92211



CHINA

Vision F250PI

Category D1

92222



CHINA

Motor	2.00 hp
Console	LCD Blue 5", Speed and Incline buttons, Heart rate sensors
Console Readings	Time, Speed, Distance, Incline, Calories, Heart rate, Body fat
Programs	12 + manual
Speed	1-14 Km/h
Incline	Electronic 15%
Deck	16mm thick with 4 pcs of anti-shock elastomer
Belt	42x123 cm, 1.8mm thick
Rollers	Front 42mm, Rear 42mm
Dimensions (open)	168x70,5x129 cm
Weight	58Kg
Max User Weight	120 Kg
Other Specs	Transport wheels, Hydraulic assistance when folding/unfolding, Bottle holder, Book holder, Line-in, Speakers, Bluetooth, APK

Motor	2.50 hp
Console	LCD Blue backlight 5", Speed and Incline buttons, Heart rate sensors
Console Readings	Time, Distance, Heart rate, Calories, Speed, Body Fat
Programs	50 + 5 user + manual
Speed	1-18 Km/h
Incline	Electronic 15%
Deck	Anti-shock 15mm
Belt	45x135 cm, 1.6mm thick
Rollers	Front 46mm, Rear 42mm
Dimensions (open)	173x72x132 cm
Weight	57,6Kg
Max User Weight	120 Kg
Other Specs	Transport wheels, Hydraulic assistance when folding/unfolding, Book holder, Bottle holder, Speakers, MP3, APK



Added two (2) springs in the front for improved shock absorption

+ Speed & Incline buttons on the hand-grips



+ Speed & Incline buttons on the hand-grips



Vision F225HI

Category D1

92221



CHINA

Valma F200HI

Category D1

92210



CHINA

Motor	2.25 hp	2.00 hp
Console	LCD Blue backlight 5", Speed buttons, Heart rate sensors	LCD Blue 5", Speed buttons, Heart rate sensors
Console Readings	Time, Distance, Heart rate, Calories, Speed, Body Fat	Time, Speed, Distance, Calories, Heart rate, Body fat
Programs	50 + 5 user + manual	12 + manual
Speed	1-18 Km/h	1-14 Km/h
Incline	Manual 3%	Manual (3 positions)
Deck	Anti-shock 15mm	16mm thick with 4 pcs of anti-shock elastomer
Belt	45x135 cm, 1.6mm thick	42x123 cm, 1.8mm thick
Rollers	Front 46mm, Rear 42mm	Front 42mm, Rear 42mm
Dimensions (open)	173x72x132 cm	168x70,5x129 cm
Weight	56,0Kg	53Kg
Max User Weight	120 Kg	100 Kg
Other Specs	Transport wheels, Hydraulic assistance when folding/unfolding, Book holder, Bottle holder, Speakers, MP3, APK	Transport wheels, Hydraulic assistance when folding/unfolding, Bottle holder, Book holder, Fan, Line-in, Speakers, Bluetooth, APK



+ Speed & Incline buttons on the hand-grips

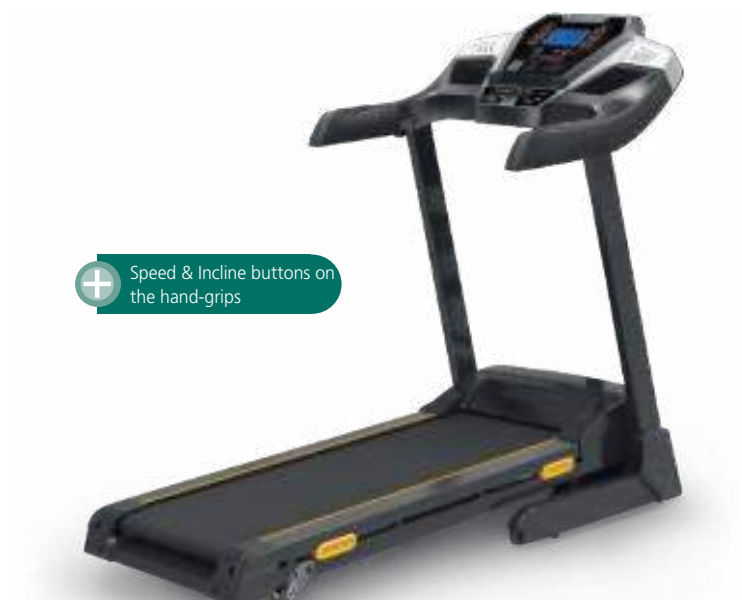

+ Speed & Incline buttons on the hand-grips



ZOOM F200PI

Category D1

92215



Motor	2.00 hp
Console	LCD Blue backlight 5", Speed and Incline buttons, Heart rate sensors
Console Readings	Time, Distance, Heart rate, Calories, Speed, Body Fat
Programs	40 + 5 user + manual
Speed	1-18 Km/h
Incline	Electronic 15%
Deck	Anti-shock 15mm
Belt	45x120 cm, 1.6mm thick
Rollers	Front 42mm, Rear 42mm
Dimensions (open)	171x72x131,5 cm
Weight	50,0Kg
Max User Weight	100 Kg
Other Specs	Transport wheels, Hydraulic assistance when folding/unfolding, Bottle holder, Speakers



+ Speed & Incline buttons on the hand-grips



For a long-term and worry-free use of a treadmill, the correct lubrication is a must

Treadmill Lubricants

It is essential to lubricate the bottom part of the treadmill's belt at regular intervals, depending on how often you use it. It is something the user himself can and should do, simply by lifting the belt by hand and spraying the deck. **Lubrication should be performed approximately every 20-30 hours of use.**

These silicon lubricants will keep your treadmill in excellent condition for many years. The 350-1000 mixture is ideal since it is thicker than the 350-density silicone, lasting for a lot more time.

In Spray Form

70056



In a Bottle

CODE	QUANTITY
70057	190ml
70058	500ml

Caution: Excessive lubrication should be avoided, causing the belt to slip. On the other hand, insufficient lubrication will damage the belt, risking damage to the motor.

Category E6

44097

Polar Heart Rate Receiver

- The most popular accessory for dedicated runners
- Essential accessory for using your treadmill with Heart Rate Programs



- You can see your day-by-day progress; also helps you to not pressure your heart too much

Category F1

ΕΛΛΕΙΠΤΙΚΑ

Πως Διαλέγουμε Ελλειπτικό

Τα ελλειπτικά χωρίζονται βάση δυο κριτηρίων:

- A.** Ανάλογα με του που βρίσκεται ο δίσκος (οι μαγνήτες)
- B.** Ανάλογα με τον τρόπο που δημιουργείται η αντίσταση

[A] Πλεονεκτήματα ελλειπτικών με τον δίσκο εμπρός

1. Η άσκηση γίνεται με πιο φυσικό και ξεκούραστο τρόπο διότι το πέλμα κινείται παράλληλα με το έδαφος και δεν επιβαρύνεται η περιοχή του αστραγάλου.
2. Η γωνία κλίσης του πέλματος όταν ο δίσκος είναι πίσω εξαρτάται από το μήκος του ελλειπτικού.
3. Λόγο σχεδιασμού, μπορούν να υποστηρίξουν χρήστες με μεγαλύτερο βάρος.

Μειονεκτήματα ελλειπτικών με τον δίσκο εμπρός

1. Έχει μεγαλύτερο μήκος. Η λύση σε αυτό το πρόβλημα δόθηκε με το πτυσσόμενο ελλειπτικό (#43331).
2. Η τιμή τους είναι συνήθως υψηλότερη από εκείνων με τον δίσκο πίσω.

Στην περίπτωση που η τιμή είναι παραπλήσια τότε συνίσταται το ελλειπτικό με μπροστινό δίσκο διότι το όφελος από την φυσική κίνηση υπερκαλύπτει όλα τα άλλα πλεονεκτήματα που ενδεχομένως μπορεί να έχει κάποιο ελλειπτικό με τον τροχό πίσω.

[B] Σύστημα Αντίστασης:

1. Χειροκίνητη διαβάθμιση αντίστασης.
2. Ηλεκτρονική διαβάθμιση αντίστασης.

Πλεονεκτήματα:

- Πολύ καλή διαβάθμιση της αντίστασης
- Δυνατότητα μέτρησης έργου σε WATT
- Δυνατότητα προγραμματισμού

3. EMS (ElectroMagneticSystem)
Ηλεκτρομαγνητική αντίσταση
(ελλειπτικά που οι μαγνήτες τους είναι ηλεκτρομαγνήτες)

Πλεονεκτήματα:

- Απόλυτα ομαλή κίνηση
- Αθόρυβη λειτουργία

4. Generator: Είναι μια βελτιωμένη έκδοση του EMS που η αντίσταση προέρχεται από την παραγωγή ενέργειας και έτσι δεν υπάρχει η ανάγκη παροχής ρεύματος. Τα συναντούμε κυρίως σε επαγγελματικά όργανα.

5. SpinElliptical: Τα SpinElliptical είναι στην κορυφή της ποιότητας και της απόδοσης.

Η αντίσταση προέρχεται από το δίσκο αδρανείας. Έχει πολύ μεγάλη σημασία το βάρος του δίσκου διότι αποτελεί τον καθοριστικό παράγοντα της ποιότητας. Η αντίσταση ενισχύεται είτε με φρένα (τακάκια), είτε με μαγνήτες νεοδυμίου.

Πλεονέκτημα:

- Ο αθλητής φτάνει πολύ πιο εύκολα σε αερόβια άσκηση ανεβάζοντας παλμούς στους 130 (70% της μέγιστης ικανότητας του) χωρίς μεγάλη κόπωση (floating effect).
- Απόλυτα ομαλή αντίσταση και στις 360° της κίνησης.

Μαγνήτες

Οι μαγνήτες ενός απλού μαγνητικού, μετά από μακρόχρονη χρήση, είναι δυνατόν να απομαγνητιστούν. Αυτός είναι και ο λόγος που δεν χρησιμοποιούνται σε επαγγελματικά ποδήλατα. Τα μεγάλα ελλειπτικά της AMILA - με μπροστινό δίσκο - που παράγονται από τη DYACO, έχουν λύσει αυτό το πρόβλημα αντικαθιστώντας τους απλούς μαγνήτες με **μαγνήτες νεοδυμίου**.

Βάρος Δίσκου

Το βάρος του δίσκου έχει πολύ μικρή σημασία στα μαγνητικά και ελλειπτικά ποδήλατα

Κύρια Σημεία Καταπόνησης

Σημαντικό ρόλο στην ποιότητα ενός ελλειπτικού παίζει το ποσοστό ενίσχυσης των τριών κύριων σημείων που υφίστανται την μεγαλύτερη καταπόνηση



Μπορούμε πολύ γρήγορα να ελέγξουμε την ποιότητα ενός ελλειπτικού προσέχοντας:

- αν σε όλη τη στροφή η αντίσταση είναι ίδια και αρμονική (smooth function)
- αν η κλιμάκωση της αντίστασης γίνεται εύκολα αντιληπτή αλλάζοντας διαδοχικά τις διαβαθμίσεις

Δρασκελισμός

Όσο μεγαλύτερος είναι ο δρασκελισμός τόσο πιο αποτελεσματική είναι η άσκηση.

Σχέση Μετάδοσης

Οι διάμετροι των δυο τροχών ενός ελλειπτικού δημιουργούν τη σχέση μετάδοσης. Στο παράδειγμα απεικονίζεται η σχέση του 43236 η οποία προκύπτει από το παραγόμενο κλάσμα των δυο διαμετρημάτων των δίσκων: $\frac{\varnothing 379}{\varnothing 40} = 9.5 / 1$

Όταν ο μεγάλος δίσκος κάνει μια περιστροφή (μια πλήρη ελλειπτική κίνηση) ο μικρός δίσκος έχει κάνει 9.5. Αυτό έχει ως αποτέλεσμα τη συχνότερη επαφή των μαγνητών και επομένως την ομαλότερη αντίσταση.

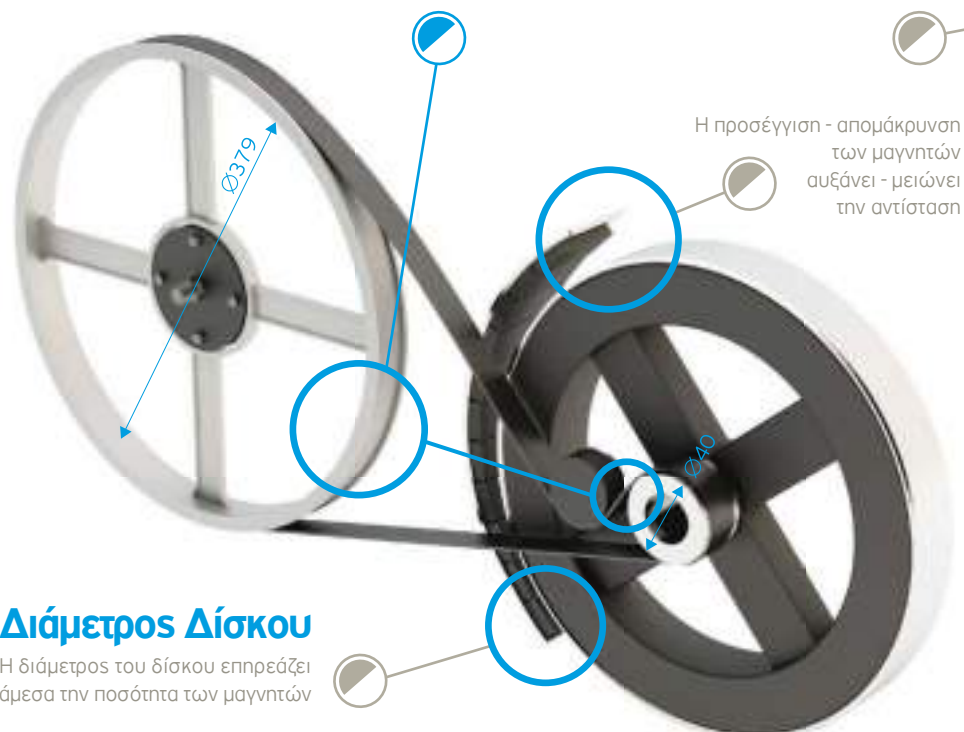

Διάμετρος Δίσκου

Η διάμετρος του δίσκου επηρεάζει άμεσα την ποσότητα των μαγνητών

Ποδήλατα

Πως Διαλέγουμε Ποδήλατο Γυμναστικής Τα ποδήλατα χωρίζονται σε δυο κατηγορίες

- A. Ορθια ή Καθιστά
- B. Ανάλογα με τον τρόπο που δημιουργείται η αντίσταση (ακριβώς όπως στα ελλειπτικά, χωρίς καμία διάφορα)

Καθιστά VS Ορθια Ποδήλατα

Πλεονεκτήματα Καθιστών

- Πολύ λιγότερη καταπόνηση της μέσης. Βασικός παράγων για άτομα που έχουν παθήσεις στη μέση ή στην σπονδυλική τους στήλη. Γι' αυτόν τον λόγο το καθιστό ποδήλατο είναι το μόνο όργανο που συνιστά η Ένωση Αμερικανών Ορθοπεδικών.
- Η άσκηση είναι πιο ξεκούραστη, χωρίς να μειώνεται η αποτελεσματικότητά της.

Μειονεκτήματα Καθιστών

- Απαιτούν μεγαλύτερο χώρο.
- Ακριβότερα από τα όρθια ποδήλατα.

Προσαρμοστικότητα

Η δυνατότητα της σέλας να προσαρμόζεται σε πολλαπλά σημεία, καθώς η ποιότητα των υλικών, επιδρούν στην άνεση της άσκησης. Ο χρήστης βρίσκει το ιδανικό σημείο για το σωματότυπο του.

Στα μαγνητικά ποδήλατα δεν έχει σημασία το βάρος του δίσκου. Σημαντικό ρόλο παίζει η διάμετρος η οποία υποδηλώνει την ποσότητα των μαγνητών. Όσο περισσότεροι μαγνήτες, τόσο πιο ομαλή και ποιοτική γίνεται η αντίσταση.

Σχέση Μετάδοσης

Η σχέση μετάδοσης της κίνησης είναι ένα σημείο που δεν προσέχουν πολλοί όμως παίζει σημαντικό ρόλο στην άσκηση.

Μανιβέλα

Υπάρχουν δυο τύποι μανιβέλας, ενός τεμαχίου και τριών. Οι μανιβέλα τριών τεμαχίων λόγω του ότι επιτυγχάνει γωνίες 90° συμβάλει στην άνεση της άσκησης, σε σχέση με τον απλό τύπο.

Ρυθμίσεις

Το πλάτος του καθίσματος και η δυνατότητα ρύθμισης της πλάτης αποτελούν σημαντικούς παράγοντες στην άνεση κατά τη χρήση.

Η στιβαρότητα κατασκευής, ο τρόπος που στηρίζεται το κάθισμα καθώς και το εύρος των ρυθμίσεών του, η απόσταση από τα πετάλια ώστε ο χρήστης να βρίσκει εύκολα την πλέον κατάλληλη θέση, είναι πολύ σημαντικά για τη σωστή άσκηση. Μια μη άνετη θέση μπορεί να προκαλέσει προβλήματα στα γόνατα του χρήστη.

Εργονομία

Στιβαρότητα

Η στιβαρότητα σε ένα ποδήλατο [βάρος, διατομή σκελετού] παίζει σημαντικό ρόλο για μια σταθερή και ασφαλή άσκηση.

Επιπλέον παράγοντες που επηρεάζουν την ποιότητα ενός ελλειπτικού

1. Ομαλή λειτουργία (smooth function)

Η ομαλή λειτουργία του ελλειπτικού χωρίς "κρατήματα" (smooth function) εξαρτάται από:

- την διάμετρο του δίσκου (δηλωτική της ποσότητας των μαγνητών).
- την ποσότητα των μαγνητών.
- την ποιότητα των μαγνητών.
- από τη σχέση μετάδοσης μεταξύ κεντρικού ρουλεμάν και δίσκου.

Μια μεγάλη σχέση μπορεί να αντισταθμίσει την ποσότητα των μαγνητών (το υποτιθέμενο βάρος του δίσκου).

2. Η ποιότητα, στιβαρότητα και σταθερότητα του ελλειπτικού συντελεί στην απουσία τριγμών δημιουργώντας την αίσθηση άνεσης. Οι παράγοντες αυτοί εξαρτώνται από:

- τη Διατομή του σκελετού,
- το Πάχος του,
- το Μέγεθος σκελετού και
- το ποσοστό ενίσχυσης των τριών κύριων σημείων που υφίστανται την μεγαλύτερη καταπόνηση. (Βλέπε Εικόνα Ελλειπτικού)

43342



- **Best** full body workout in its class
- **Eliminates** strain from hips, ankles, and knees
- **Integrated** technology makes progress easy
- **Multigrip** handles and adjustable foot pedals
- **Bluetooth** heart rate monitor
- **Bluetooth** speaker

Pedals that adjust to different settings, allowing for multiple users with varying heights and strides to be able to use the machine comfortably and eliminates the «numb toe» feeling sometimes associated with elliptical use.

The 2 degree inward slope realigns the body into its correct posture for workouts limiting aches and pains, creating a comfortable workout, thus increasing the longevity of wanting to exercise.



E35 SOLE

Built-in wireless heart rate receiver and chest strap, Bottle holder, USB charging, Bluetooth HR, Bluetooth Speaker, Cooling Fans, Tablet holder

Computer: LCD 7,5" backlit with multiple concurrent readings

Readings: Time, Speed, Distance, Heart rate, Calories, Level, Program, Pace, Rotations per minute, Watt, Laps & Incline

Programs: 5 + 1 manual + 2 user + 2 HRC

Disk: 11,4Kgr

Rail: **Double rail for increased stability**

Incline: **20 levels (electronically controlled)**

Resistance: 20 levels (electronically controlled)

Weight: 111Kg

Stride: 51cm

Pedal angle adjustment: 3 levels, using a pin

Heart Rate: Touch and wireless

Max User Weight: 150Kg



> External power source (included in the packaging) 209×82×180cm

Category F1

43320

 TAIWAN

Semi-Commercial Grade

For Personal Training or very small Gyms



XE 150 AMILA®

Electromagnetic Resistance

Absolutely natural movement

Computer: LCD Back lighted, 6 buttons for start/stop, reset, enter, up, down, recovery. Fan

Readings: Time, Distance, Calories, Watt, Heart rate, Rotations per minute

Programs: 12 + 1 manual + 1 user + 1 HRC

Rail: **Double rail for increased stability**

Disk: Ø292mm, 10,4Kgr

Gear ratio: 01:08,3

Pulley: PU Ø330mm

Resistance: Electronic 16 levels

Crank: 2 pcs, Ø508mm

Weight: 101Kg

Step: 51cm

Heart Rate: Touch

Max User Weight: 150Kg



> External power source (included in the packaging)

190×60×170cm

Category F1

92306



CHINA



EFIT 41800EHP

Tablet/smartphone stand. **USB charging.**
Integrated transport wheels. **Bottle holder.**

Console: LCD 131x67mm

Readings: Time, Speed, Distance, Pulse, Scan, Calories, Watt, RPM, Body fat, Recovery

Disk: 7Kg, 260mm

Stride: 400mm

Transmission: Belt

Resistance: Electromagnetic 16 levels

Axle: Ø20x224mm

Pedals: 417x210mm, 77mm apart

Main tube: 50x55x1,5mm

Weight: 53,6kg

Gear ratio: 1:7

Heart rate: Touch and Wireless

Max User Weight: 120Kg

➤ External power source
(included in the packaging)



158,5×56×170,8cm

Category
D3

92307



CHINA



EX6P

Tablet/smartphone stand. **Bluetooth & APK.** Integrated transport wheels.

Console: LCD 132x66mm

Programs: 13

Readings: Time, Speed, Distance, Pulse, Calories, RPM, Watt, Body fat

Disk: 6Kg, 280mm

Stride: 340mm

Transmission: Belt

Resistance: Electromagnetic 32 levels

Axle: Ø20x141mm

Pedals: 394x155x75mm

Weight: 43,5 Kg

Heart rate: Touch

Max User Weight: 120Kg



132×53×158cm

Category
D3

92305



CHINA



EX6

Tablet/smartphone stand. Integrated transport wheels.

- Console:** LCD 80x50mm
- Readings:** Time, Speed, Distance, Pulse, Calories, RPM, Scan, Body fat
- Disk:** 6Kg, 240mm
- Stride:** 340mm
- Resistance:** Magnetic/manual 8 levels
- Axle:** Ø20x141mm
- Pedals:** 394x155x75mm
- Heart rate:** Touch
- Transmission:** Belt
- Weight:** 41,5 Kg
- Max User Weight:** 120Kg



117,5×52,8×164,5cm

Category D3

92300



CHINA



Cardio 5105E

Electromagnetic. Integrated transport wheels.

- Readings:** Time, Speed, Distance, Calories, Heart rate, Scan, Odo
- Disk:** 4Kg
- Resistance:** Magnetic/manual 8 levels
- Weight:** 25 Kg
- Pedals:** Large size, non-skid
- Heart rate:** Touch



SCAN HERE to view the Assembly Video on our YouTube channel.



129×59×159cm

Category D3

43345

XTEERRA FITNESS



CHINA



> Oversized pedals



> Adjustable seat



> Anatomic cushion



> External power source (included in the packaging)

148,5×65×116,5cm

Category D3

R15 XTEERRA FITNESS

Mobile device holder. Adjustable seat. Bottle holder. Oversized pedals. Integrated transport wheels.

Computer: LCD 14cm blue back-lit with 6 buttons

Readings: Time, Speed, Watt, Distance, Calories, Heart rate, RPM, Body fat, HR Control, Pulse recovery

Disk: Ø260mm, 7Kg

Programs: 12 preset, 4 user, 5 HRC, 1 body fat, 1 manual

Crank arm: 340mm

Resistance: Electronic 24 levels

Weight: 37,8Kg

Heart rate: Touch and Polar

Max User Weight: 120Kg

92451



CHINA



ATLAS 600R AMILA®

Tablet stand

Computer: LCD 111x61,5mm with 5 buttons

Readings: Time, Speed, Distance, Calories, Heart rate, Rotations per minute, Body fat, Recovery, Temperature

Disk: Ø240mm, 5Kg

Gear ratio: 01:07,6

Bearings: 6000Z

Axle: Ø17mm thick

Transmission: Belt

Main tube: Rectangular, 80×40×2mm

Resistance: Manual 10 levels

Weight: 44Kg

Heart rate: Touch

User height: 155-190cm

Max User Weight: 120Kg



SCAN HERE to view the Assembly Video on our YouTube channel.

161×67×114cm

Category D3

43348



CHINA

**Semi-Commercial
Grade**

Tour (PRO-681G) AMILA®

Ideal for group sessions.

Infinite adjustments for saddle/handlebar.

Transport wheels. Emergency brake.

Resistance: Hand regulated, break on the top side

Frame: Steel, anti-rust coated

Saddle: Microadjustable, front/back & up/down

Handlebars: Microadjustable, front/back & up/down

Grips: Single

Pedals: Single

Transmission: Chain

Bearings: Sealed

Crank: 30B, 170mm

Disk: 20kg cast iron

Weight: 50,5kg

Ratio: 1:3

Max user weight: 130Kg



140×65×130cm

Category
F1

44201



TAIWAN

**HOME
USE**



CRANK

Home use, as well for Hotels and very small Gyms.

Not suitable for group sessions.

Grips: Adjustable Up-Down, Front-Back

Seat: Adjustable Up-Down, Front-Back

Drive: Chain

Disk: 18,5Kgr cast iron

Resistance: Manually adjustable

Bearings: Plain

Axle: 1,37" x 24T

Crank: 1/8", 52t, 170mm

Weight: 47kg

Ratio: 1:3

Max user weight: 130Kg



130×65×130cm

Category
D3

92408



CHINA



!!! The pictured tablet IS NOT included !!!



Corsa IC911

- Console:** LCD 7,7x4,3cm with Set, Mode/Enter & Reset/Recovery buttons
- Readings:** Speed, Time, Distance, RPMs, Calories, Scan
- Programs:** User, Calories
- Grips:** Adjustable Up-Down
- Seat:** Adjustable Up-Down, Front-Back
- Drive:** Belt
- Resistance:** 8 levels, manually adjustable
- Bearings:** 3 pcs
- Axle:** Ø20x170mm
- Weight:** 37,2kg
- Ratio:** 1:5,7
- Heart rate:** Touch
- Max user weight:** 110Kg

154,5x54x110cm

Category D3

44217



SCAN HERE  to view the Assembly Video on our YouTube channel.



Cyclocross AMILA®

- Transport wheels. Emergency brake.**
- Resistance:** Hand regulated, break on the top side
- Console:** LCD
- Display:** Scan, Speed, Time, Distance, Calories, ODO
- Saddle:** Adjustable, front/back & up/down
- Handlebars:** Adjustable, front/back & up/down
- Transmission:** Belt
- Disk:** Ø460mm 18kg
- Weight:** 44kg
- Max user weight:** 125Kg



115x52x116cm

Category F1

92405



CHINA



SCAN HERE to view the Assembly Video on our YouTube channel.



> External power source (included in the packaging)

109×54×142cm

Category D3

Aston BX7P

Integrated transport wheels. Tablet/smartphone holder. Magnetic bike.

- Readings:** Time, RPM, Distance, Heart rate, Speed, Watt, Calories, Recovery, Body fat
- Transmission:** Belt
- Disk:** 5Kg
- Crank:** Three-piece
- Resistance:** Electronically adjusted
- Programa:** 12 + HRC + Watt + User
- Seat:** Adjustable Up-Down, Front-Back
- Grips:** Padded armrests
- Heart rate:** Touch
- Max User Weight:** 120Kg

92403



CHINA



Aston BX7

Integrated transport wheels. Tablet/smartphone holder. Magnetic bike.

- Readings:** Time, Distance, Heart rate, Speed, Calories, Recovery, Body fat
- Transmission:** Belt
- Disk:** 5Kg
- Crank:** Three-piece
- Resistance:** Manual/magnetic 10 levels
- Seat:** Adjustable Up-Down, Front-Back
- Grips:** Padded armrests
- Weight:** 34 Kg
- Heart rate:** Touch
- Max User Weight:** 120Kg

109×54×142cm

Category D3

92411



CHINA



- + Excellent resistance scaling
- + 3-piece split crank design

Eclipse

Magnetic bike. Integrated transport wheels.

Readings: Time, Distance, Speed, Calories, Heart rate, Scan, Odo

Transmission: Belt

Disk: 5Kg

Crank: Three-piece

Resistance: Manual/magnetic 8 levels

Seat: Adjustable Up-Down, Front-Back

Weight: 24 Kg

Heart rate: Touch

Max User Weight: 130Kg

90x50x130cm

Category D3

92400



CHINA



SCAN HERE to view the Assembly Video on our YouTube channel.

- + Very good resistance scaling



Cardio 5105B

Magnetic bike. Integrated transport wheels.

Readings: Time, Speed, Distance, Calories, Heart rate, Scan, Odo

Transmission: Belt

Disk: 4Kg

Crank: One-piece

Weight: 25,5 Kg

Grips: Microadjustable

Resistance: Manual/magnetic 8 levels

Seat: Adjustable Up-Down, Front-Back

Heart rate: Touch

Max User Weight: 100Kg

83x50x138cm

Category D3

43257

Commercial Grade

- > **LCD:** 2 colors
- > **Resistance:** 24 levels, aeromagnetic, automatically controlled
- > **Programs:** 43, including Pacer, Interval, H.R.C. and Recovery
- > **User profiles:** 5
- > Pedals with adjustable heel support
- > Supports tall users
- > External power source



> **Rail with stainless steel strips,** lifelong endurance

> **Stabilizers** which, under the covers, have holes for mounting on the floor

> **Adjustable foot:** Designed to project slightly, offering additional strength



235,7×52,4×85.6cm

Category F1

92351

- > **Readings:** Time, Time/500m, SPM, Distance, WATT, Strokes, Total strokes, Calories
- > **Pulse:** Wireless receiver
- > **Resistance:** Magnetic 12 levels
- > **Beam:** Aluminium

- > Durable pulling rope
- > Anti-skid pedals with quick-adjust strap
- > Oversized padded seat provides a soft secure ride
- > Space saver storage
- > Wheels for easy transport



SCAN HERE to view the presentation video on our YouTube channel

Magnetic Rower



Adjustable pedals, with quick adjustment straps



The innovative (Double Slide) aluminium rail offers durable stability



Dual resistance (air and magnetic), leads a comfortable and smooth rowing feeling



205×47×122cm

Weight 50Kg

Category D7

Water Rower

92355

- > **Readings:** Reps, Time, Distance, Calories, Temperature, Clock
- > **Resistance:** 6 levels
- > **Pedals:** 6 positions
- > **Main tube:** 1090x60x30mm, 1,8mm thick
- > **Water capacity:** 12~18lt
- > **Max User Weight:** 130kg



SCAN HERE 
to view the presentation
video on our
YouTube channel

Weight 39 Kg Category D7

203x56x92,5cm

92356

- > **Readings:** LCD 75x42mm, Time, Distance, Calories, Clock
- > **Drive:** Belt
- > **Beam:** Aluminium 109cm
- > **Resistance:** Air and 12 levels Magnetic
- > **Disk weight:** 2,5kg
- > **Max user weight:** 110Kg
- > Foldable, requiring small storage space
- > Tablet stand



USAGE WITH PHONE

- + Bluetooth
- + Compatible APKs: Kinomap, FitShow

Weight 27 Kg Category D7

200x47x85cm

Air walkers

44079

- Exercises heart, lungs and vascular system
- › **Counter:** Scan, Time, count, Total count, Calories
- › **Max user weight:** 80Kg
- **Movement: Front-back and sideways**



SCAN HERE  to view the presentation video on our YouTube channel



Weight
17 Kg

Category
E6



2-in-1 Air Walker & Split Thigh

Non-impact aerobic action makes exercising easier for people of all ages

Assembled
79×53×128cm
Folded
40×53×138cm

44286

Air Walker With adjustable resistance

Trains the hips. Feet and hands movement pistons. Double immobilization safety and height adjustment

- › **6 levels adjustable resistance**
- › **Counter:** Time, Calories, Distance, Reps/min
- › **Max user weight:** 100kg
- › **Packaging:** Box



102×83×135cm



Weight
24.5kg

Category
D7

44272

Air Walker

Trains the hips. Feet and hands movement pistons. Double immobilization safety and height adjustment

- › **Counter:** Time, Calories, Distance, Reps/min
- › **Max user weight:** 100kg
- › **Packaging:** Box



108×74×138cm



Weight
26kg

Category
D7

44078

2-in-1 Exercise Pedaler

Simple way to exercise upper and lower body



- Post angle adjustable
- Improves body flexibility and circulation

> **Tension:**
Adjustable by hand

Weight
6 Kg

Category
E6

100×54×43cm

43297

Mini Pedaler

Without a seat. Ideal for kinesiotherapy. For both hands and feet. Assistance adjuster.

- > **Pedals:** Antislip with straps
- > **Folds** for easy transport/storage (dimensions folded: 37x28x20cm)
- > **Computer:** Scan, Time, Calories, Reps (& total)
- > **Packaging:** Box



Weight
3,5kg

Std Pack
1

Category
D7

48×37×26,5cm

43300

Mini Bike

Without a seat. Ideal for kinesiotherapy. Assistance adjuster.

- > **Pedals:** Antislip with straps
- > **Computer:** Scan, Time, Calories, Reps (& total)
- > **Packaging:** Box



Weight
7,5kg

Category
D7

36×37×37cm

- > **Material:** Rubber
- > **Packaging:** Box

Rubber Protection Mat



CODE	DIMENSIONS
81724	200x92,5x0,4 cm
81725	160x87,0x0,4 cm
81726	100x70,0x0,4 cm

Category
E4

46420

Power Cage

+ Very strong 7,5x7,5cm x 3mm beam construction



Büpos 340 kg Category F2

! The accessories with the icon "⚠" are not included with Power Cage (#46420)

314x211x274cm

J-hooks

⚠ 46422



Safety holder

⚠ 46423



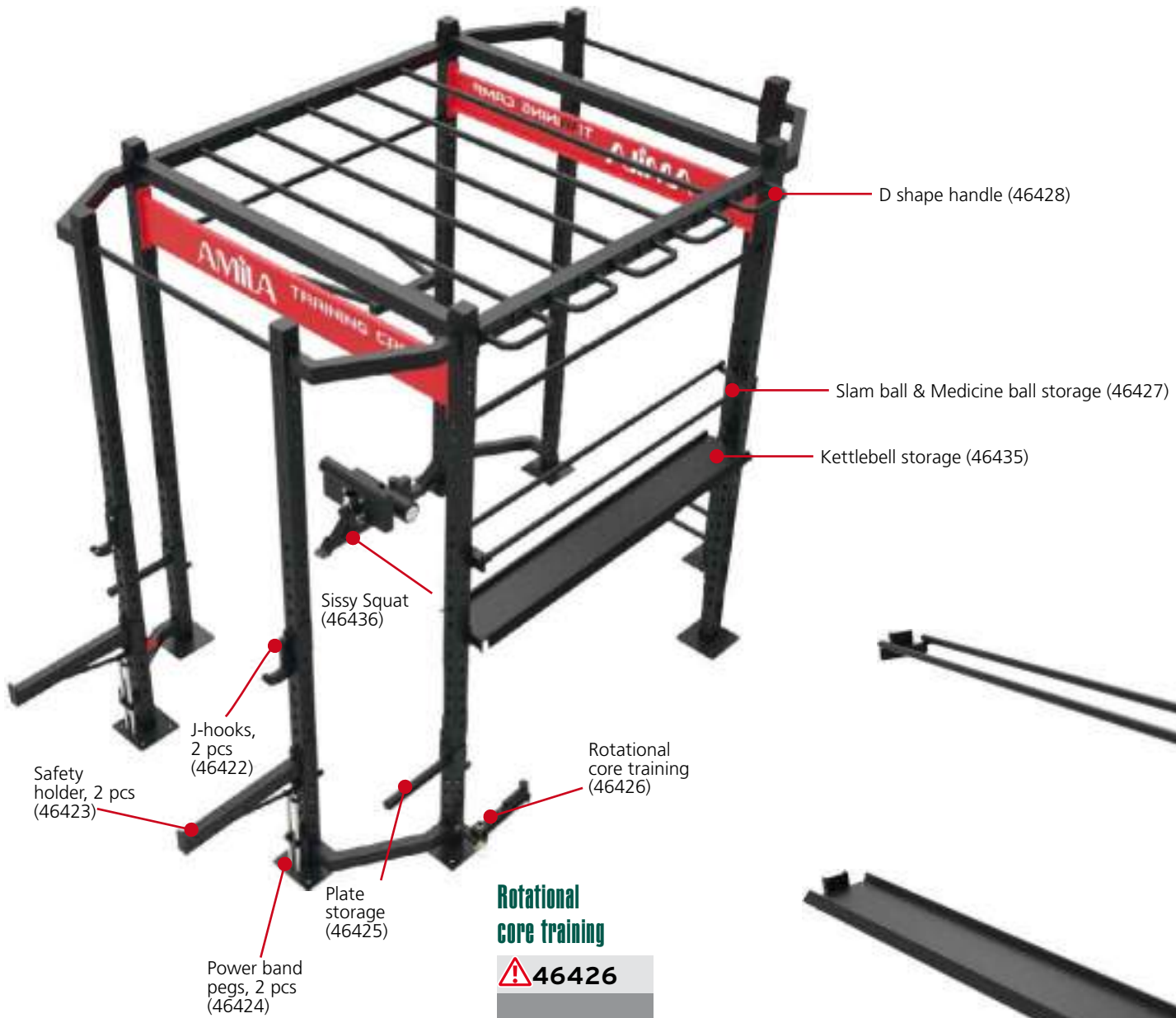

Slam ball & Medicine ball storage

⚠️ 46427



Kettlebell storage

⚠️ 46435



Rotational core training

⚠️ 46426



Sissy Squat

⚠️ 46436

Dip horn

⚠️ 46421



Plate storage

⚠️ 46425



D shape handle

⚠️ 46428



Power band pegs

⚠️ 46424









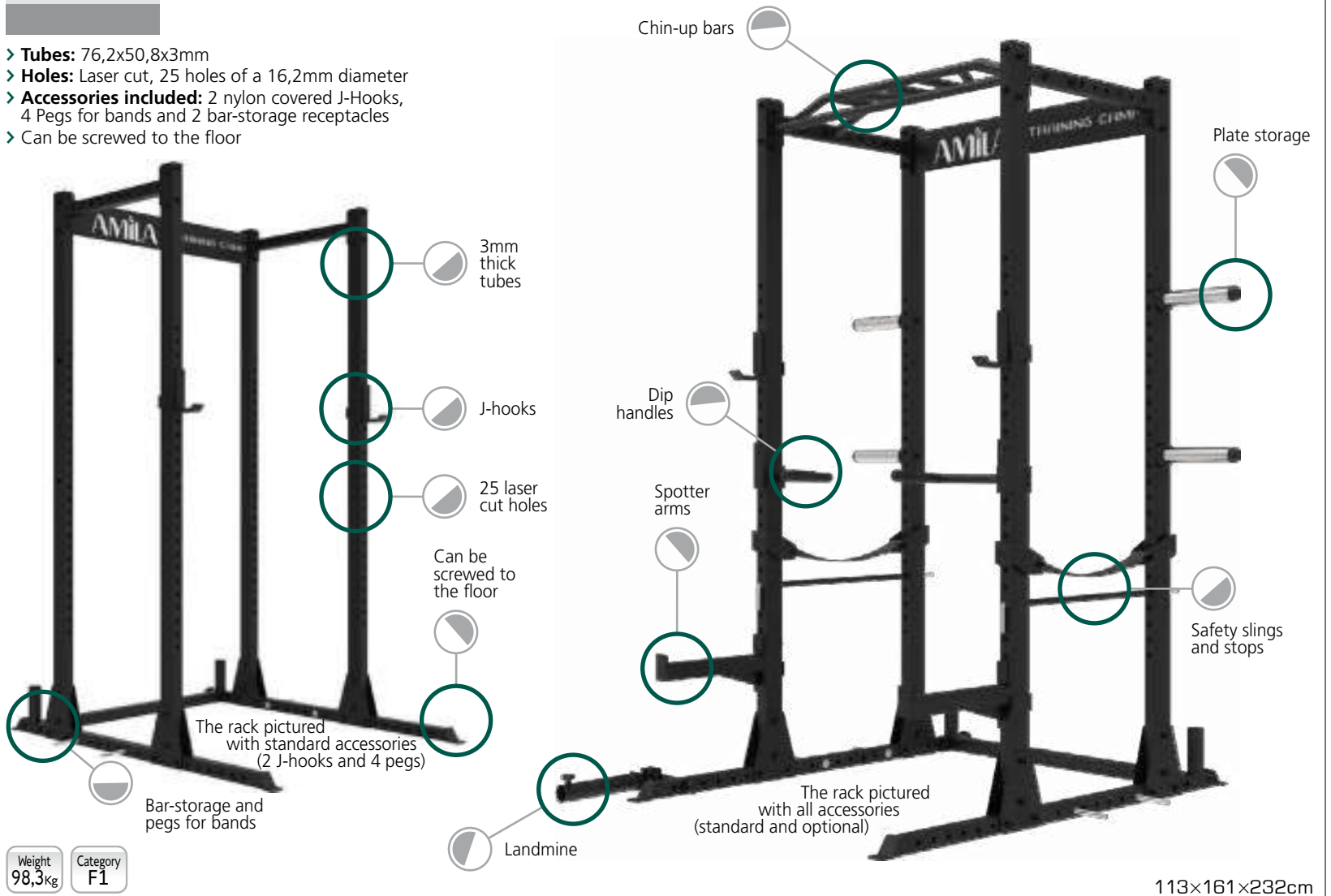

95200

- > **Tubes:** 76,2x50,8x3mm
- > **Holes:** Laser cut, 25 holes of a 16,2mm diameter
- > **Accessories included:** 2 nylon covered J-Hooks, 4 Pegs for bands and 2 bar-storage receptacles
- > Can be screwed to the floor

Power Rack Compact Training Camp



Customize your Rack according to your needs by adding accessories from the wide variety of AMILA Power Rack Training Camp. The available accessories to choose from are as follows:

<p>Multiple grip chin-up bar</p> <p>95220</p> 	<p>Chin-up bar</p> <p>95221</p> 	<p>Safety sling</p> <p>95222</p> <p>(2 pcs)</p> 
<p>Spotter arms</p> <p>95223</p> <p>(2 pcs)</p> 	<p>Safety stop</p> <p>95224</p> <p>(2 pcs)</p> 	<p>J-hooks</p> <p>95225</p> <p>(2 pcs)</p> 
<p>Landmine</p> <p>95226</p> 	<p>Dip handles</p> <p>95227</p> <p>(2 pcs)</p> 	<p>4 pcs plate storage</p> <p>95228</p> <p>(4 pcs)</p> 

43963

Alpha Power Rack

The ideal power rack for people with limited available space

> Tube size: 60x60x2mm

Pull-up grips

The split pull-up grips let you choose the ones you need for your workout

Adjust it to your need

The J-Hooks' and safety bars' adjustable height allows you to adjust the Power Rack according to your needs



Base

The holes on the base allow you to bolt it on the floor for added stability

Category F1

214x118,9x133,7

91206

Semi-Commercial Grade

Half Rack HR350

> Tube: 40x80x1.5mm



Weight 37kg

Category F1

129x151x218cm

46105

AMILA Iron Wall Bar

FULL Commercial Grade

> Tubes: 60x10x2 and Ø32x1,5



> Rings: Eight on each side to connect Gym bands

Category F1

260x100x46cm

70065

Wall Bar

Reinforced, higher quality wood with anti-humidity sealer

- > Material: Sustainable high quality Sal wood
- > Bars: 4cm diameter
- > Wall mountable (4 points)
- > Strength: 120kg

Weight 26,5kg

Category F6



250x100x24,5cm

Time to relax Time for MASSAGE

AMILA®



We have focused in creating a series of comfortable massage chairs, with the [quality and functionality of AMILA products](#), that will fully cover everyone's needs without limitations.

TRAIN WITHOUT PAINS AFTER

Athletic masage **relieves** cramps, **reduces muscle spasms** by removing lactic acid.

It is by far **the most effective way to deal with inflammation caused by sport activities** and the best in preventing and recovering from micro-injuries from intense training.





COMFORT AT HOME

Place a massage chair in your house and enjoy the quality of a modern clinic when you need it, without any second thoughts.

INNOVATING IN HOSPITALITY

Don't follow the stereotypes, stand out. Place a massage chair in your hotel room on the days you are asked for it and supply your guests with a **unique hospitality experience** after an exhausting day of outdoor activities or when the weather does not allow them.



S-Shape

The **body supporting S-shape** includes a combination of back massage structures and human mechanics principles, so that you can enjoy a high-tech back massage. It provides support to both your neck and back, especially in the lumbar region

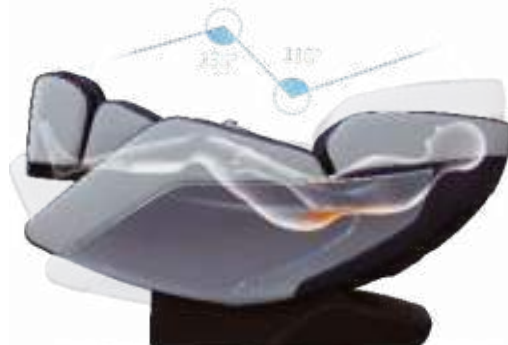

ZERO GRAVITY

The 135° and 118° zero gravity angles, simulating space flight, move thighs and calves higher than the waist, achieving full relaxation.



FULL BODY STRETCH

This position increases the massage effects as it allows to each spinal disc to individually separate and decompress, allowing nutrients to enter the disc tissues.



INTELLIGENT MECHANICAL ARMS

The mechanical massager's "smart hands" continuously collect data on the curve of the back and mimic the skills of the professional masseuse to perform a multidimensional massage.

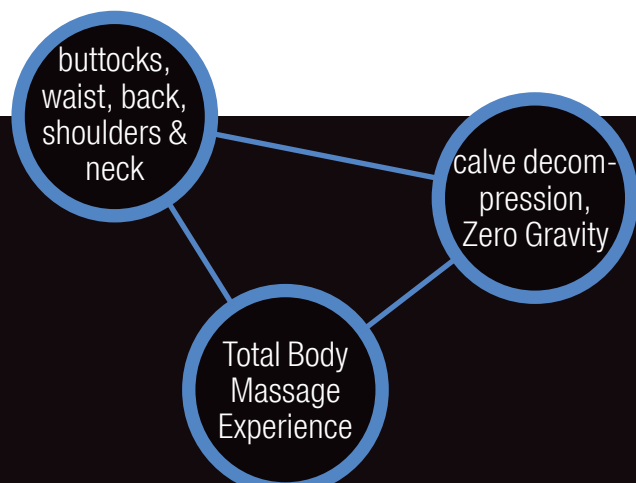

Intelligent Massage Chair

VOICE CONTROL

The intelligent voice recognition system makes it easier to control the chair.

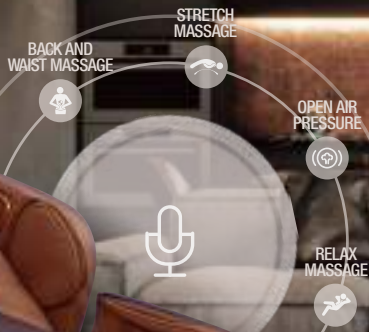
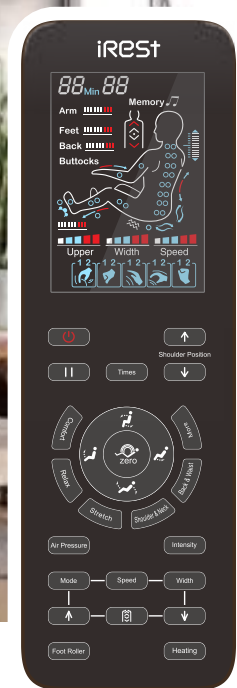

4601301

> Color: Brown/Beige



4601302

> Color: Black/Grey



Category D1

- > Programs: 12
- > Noise: ≤60dB
- > Consumption: 120W
- > Weight: 88Kg
- > Recycling tax: 4,2€



SCAN HERE 
Watch the Video Presentation of the Intelligent Massage Chair AMILA 46013XX on our YouTube channel.

- 
Back & Waist Massage
- 
Relaxing Massage
- 
Shoulder & Neck Massage
- 
Whole Body Massage
- 
Stretching Massage
- 
Spine Protection Massage
- 
Relaxing Massage
- 
Air Pressure Massage
- 
Fatigue Recovery
- 
Buttocks Massage
- 
Soothing Sleep Massage
- 
Stretching & Ligament Activation Massage

Shoulder & Neck Massage

Full Body Massage

Lower Limbs Massage

After 20 minutes of use, the chair stops by itself. In case of continuous use for a long period of time, the overheating fuse might automatically activate, in which case the chair will stop working for a period of 30 minutes in order for the motor to cool down.



INTELLIGENT MECHANICAL MASSAGE HANDS



The mechanical massager's "smart hands" continuously collect data on the curve of the back and mimic the skills of the professional masseuse to perform a multidimensional massage, by imitating his methods to perform sequences such as: finger presses, kneading and tapping. Thus, the mechanical arms can perform an effective massage to the cervical, thoracic and lumbar vertebra. This method can guarantee that the back can receive even a strong massage, refresh and relieve you from fatigue.



USB Charging



Bluetooth Speakers



Shortcut Keys



LED Light





21 Massage Programs



5 Intensity Levels



5 Gear Widths



3 Distinct Speeds



46001

- > Programs: 21
- > Noise: ≤60dB
- > Consumption: 150W
- > Weight: 100Kg
- > Recycling tax: 16,83€

Category D1

HYPERBOLIC RAIL

Based on human engineering and research on different human body curves, a new generation of hyperbolic rail was developed which can fit the neck, shoulders, back, waist, hips and legs in all directions 27-point, total length 135cm. With double V massage robot, it can massage the human body more closely and deeply.



Fast



Comfortable



Relaxing



Stretching



Whole body



Neck & shoulder



Back & waist



Stress relieving



Energy



Good-night sleep



Joint care



Neck & shoulder care



Spine Massage



Office regiment



Sport recovery



Brain refresh



Spine care



Waist care



Legs care



Rejuvenation

Human health detection function



Armrest controller



Storage space & USB charging



Bluetooth speakers



Soft pillow



FULL-BODY STRETCH

Relax waist and beautify the buttocks, stretch the whole body. Stretch the Governor Vessel on the lower back and the Foot Sun Bladder Meridian. Helpful to the space between vertebrae.



ZERO SPACE

Unique one-button translation forward slide design about 5CM against the wall will fully open the massage chair, greatly saving space



ZERO GRAVITY

The 135° and 118° zero-gravity angles that simulate spaceflight make the thighs and calves higher than the heart part of the body as if in a state of "weightlessness", making the spine free of pressure and achieving deep relaxation

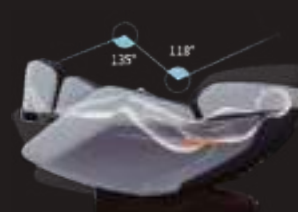

VOICE CONTROL

Intelligent voice recognition system makes it easier to control the massage chair to enjoy the comfort.

8 MASSAGE MODES

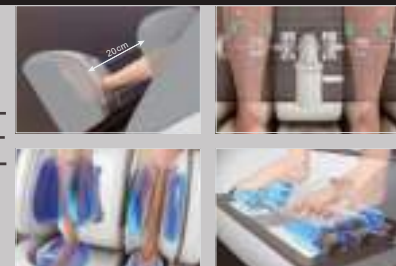

FutureForesee

StereoMassage



46011

Category
D1

- > Programs: 3
- > Noise: ≤60dB
- > Consumption: 60W

- > Weight: 33Kg
- > Recycling tax: 4,2€



Cup Holder



Shortcut Keys



Bluetooth Speakers



KNOCK

Surface massage, relieves from fatigue, recovers elasticity and frees the bones.

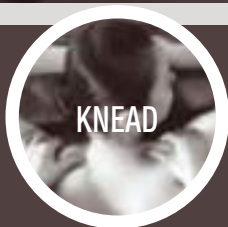

KNEAD

Soothing massage on muscles and skin to relieve pressure by simulating the human touch.

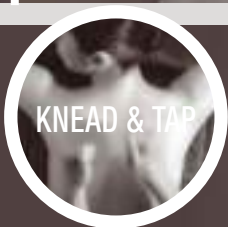

KNEAD & TAP

Combined massage for muscle stimulation, flexibility recovery and fatigue removal after a workout.



SHAPE CURVED RAIL

Full Body Comfort Massage

The S-curve technology has been based on human body mechanics. The total length of the massager is 88cm, from shoulder to thigh, helping to retain the S-shape of the human body, relax the vertebrae and relax the muscles.

The four (4) airbags built into the sides of the seat act on your hip the same way a professional masseuse swings your body, effectively relieving the pressure on the pelvis, improving the tension of the waist and the hip muscles, so that you get a better body shape.



The standardised massage methods of professional massage therapists have been processed and integrated into the chair's microchip, so that the "mechanical hands" that are controlled by the program you choose provide you a **real simulation**.

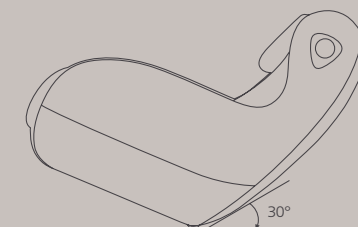

When the center of gravity goes past the wheels, the chair can easily be transported by hand. The angle must be at least 30 degrees.

SIMPLY EVERYWHERE

Lightweight and easy to use. You can move it around by a light push on the top, transforming any place to your own massage room.

After 20 minutes of use, the chair stops by itself. In case of continuous use for a long period of time, the overheating fuse might automatically activate, in which case the chair will stop working for a period of 30 minutes in order for the motor to cool down.



Controller on the armrest

USB charging



46000

- > Programs: 8
- > Noise: ≤60dB
- > Consumption: 90W

- > Weight: 61,4Kg
- > Recycling tax: 14,25€

Category D1



Fast



Comfort

8



Relax



Full body



Neck & shoulder



Back & waist



Stretch



Sport recovery

38 Αερόσακoi & Zero Gravity

The guide rail of the backrest frame adopts curved guide rail technology, which completely conforms to the back of the human body.



Pillow pad freely adjustable up and down

Automatic shoulder detection

Carbon fiber on the back are used as a far infrared heat source

Full leg massage, including sole and toes

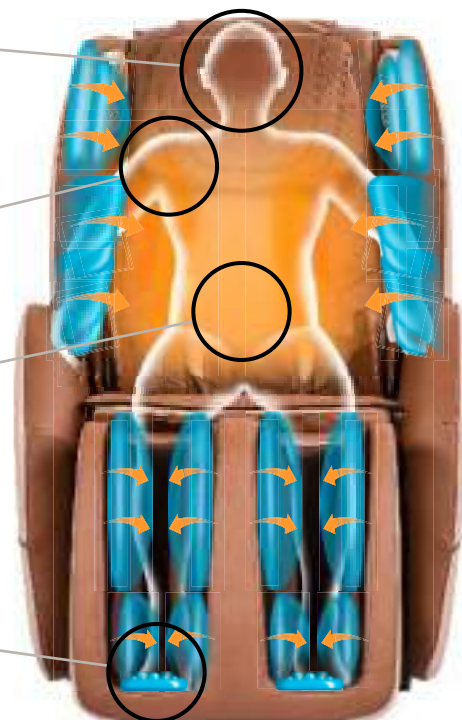

voice control

Intelligent voice recognition system makes it easier to control the massage chair

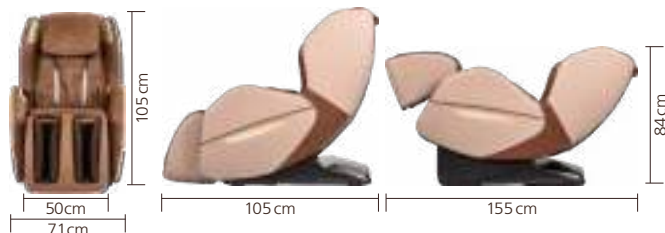

Bluetooth Speakers



Shortcut Keys



LED Lighting

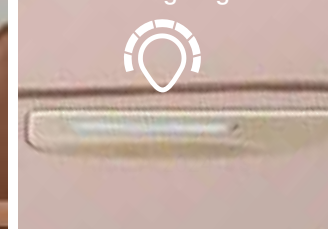

Σάουνα Υπερύθρων

Για τον οργανισμό μας, το να ιδρώνει είναι ο πιο ασφαλής τρόπος για να αναρρώνει και να παραμένει υγιής... και οι Σάουνες Υπερύθρων της AMILA, έχουν σχεδιαστεί για να σας χαρίζουν το πιο βαθύ, αποτελεσματικό, αποτοξινωτικό και χαλαρωτικό ιδρώμα.

Τι είναι οι υπέρυθρες ακτίνες;

Οι υπέρυθρες ακτίνες παράγονται κυρίως από τον Ήλιο και βρίσκονται στο αόρατο φάσμα των ηλιακών ακτινών, με μήκος κύματος 4-1000 Hz. Είναι απόλυτα φυσικές και, όχι μόνο είναι τελείως ακίνδυνες για τον άνθρωπο, αλλά είναι και χρήσιμες.

Τις κρύες αλλά ηλιόλουστες μέρες του χειμώνα ζεσταινόμαστε από τις υπεριώδεις ακτίνες του Ήλιου. Ακόμη και οι γνώστες σόμπες/ομπρέλες υγραερίου εξωτερικού χώρου παράγουν ένα είδος υπέρυθρης ακτινοβολίας για να μας ζεστάνουν.

Πως δουλεύει η Σάουνα Υπερύθρων

Το κύριο και ενδιαφέρον χαρακτηριστικό των υπέρυθρων ακτινών που τις κάνει χρήσιμες είναι ότι μπορούν να εισχωρήσουν βαθιά στο δέρμα έως και 5 εκατοστά. Έτσι, οι υπέρυθρες ακτίνες στις σάουνες διαπερνούν το σώμα και ωθούν τον ιδρώτα έξω από το σώμα, σε αντίθεση με τις συμβατικές που τραβούν τον ιδρώτα από το σώμα. Το σώμα θερμαίνεται από μέσα προς τα έξω, ως αποτέλεσμα της αντίληψης που προκαλούν οι υπέρυθρες και ενεργοποιούν τα μόρια νερού και αυτά, παλλόμενα μεταξύ τους, αυξάνουν την εσωτερική θερμοκρασία. Καθώς η εσωτερική θερμοκρασία του σώματος αυξάνεται, οι τοξίνες αναγκάζονται να βγουν μέσω του δέρματος. Η θερμοκρασία μιας υπέρυθρης σάουνας είναι συνήθως μεταξύ 32°-49°C, πολύ πιο άνετα σε σχέση με μια παραδοσιακή σάουνα η οποία λειτουργεί μεταξύ 80°-104°C. Ωστόσο, παρά το ότι λειτουργεί σε χαμηλότερη θερμοκρασία, θα ιδρώνετε πολύ περισσότερο επειδή η υπέρυθρη ενέργεια διαπερνά το σώμα σας σε ένα πολύ βαθύτερο επίπεδο.

Το λίπος γίνεται διαλυτό και τελικά απομακρύνεται από το σώμα μέσω της εφίδρωσης, με αποτέλεσμα την απώλεια βάρους. Οι τοξίνες επίσης αποβάλλονται μέσω του δέρματός σας με τη βοήθεια χαμηλότερων και πιο άνετων θερμοκρασιών.

Το Ξέρατε Αυτό; *

Η σάουνα και οι θεραπευτικές της ιδιότητες ήταν γνωστές στους Φινλανδούς, Ρώσους, Τούρκους, ακόμη και Ινδιάνους της Αμερικής εδώ και 1100 χρόνια. Αυτή τη στιγμή στη Φινλανδία, σε ένα πληθυσμό 5 εκ., υπάρχουν 2 εκ. σάουνες, εκ των οποίων το 1,2 εκ. είναι σε σπίτια και οι άλλες 800.000 σε ξενοδοχεία, γυμναστήρια και club. Για ένα πληθυσμό 5 εκατομμυρίων, αυτό είναι μια μεγάλη αναλογία.

Ελάχιστη Σπατάλη Ενέργειας

Στην κλασική σάουνα, το αποτέλεσμα έρχεται με έμμεσο τρόπο. Η αντίσταση ζεσταίνει πρώτα το περιβάλλον και έτσι χάνεται το 75% της ενέργειας. Στη σάουνα υπέρυθρων, μόνο το 20% της ενέργειας χάνεται στο αέρα, ενώ το 80% χρησιμοποιείται για να θερμάνει το σώμα μας από μέσα.

* Σύγκριση Σάουνας Υπερύθρων & Συμβατικής

Σύγκριση Σάουνας Υπερύθρων & Συμβατικής	Υπέρυθρη Σάουνα	Παραδοσιακή Φινλανδική Σάουνα
Υλικό κατασκευής	Ξύλο	Ξύλο
Ασφάλεια	Πιο ασφαλής, δεν υπάρχουν θερμές επιφάνειες ή υψηλές θερμοκρασίες	Ασφαλής, με θερμές επιφάνειες
Πηγή θερμότητας	Σόμπα υπέρυθρων	Ηλεκτρικό θερμαντικό στοιχείο
Μετάδοση θερμότητας	Υπέρυθρες ακτίνες	Ζεστός αέρας
Θέρμανση σώματος	Μέχρι 7,5 εκατοστά κάτω από το δέρμα	Επιφάνεια του σώματος
Θερμοκρασία	43°- 65°C	πάνω από 80°C
Κατανάλωση ρεύματος	1 - 2,5kW	3 - 6kW
Χρόνος προετοιμασίας	20 λεπτά	30 - 90 λεπτά
Κυκλοφορία φρέσκου αέρα	Ναι	Όχι
Εξοπλισμός νερού	Δεν χρειάζεται	Ναι
Επίπεδο άνεσης	Πολύ υψηλή	Πολύ χαμηλή
Τοποθεσία σάουνας	Οπουδήποτε στο σπίτι	Η σάουνα χρειάζεται ένα δοχείο αποχέτευσης

Στα + (συν) της σάουνας υπέρυθρων είναι και τα ακόλουθα πλεονεκτήματα

- + Δε χρειάζεται ειδικό χώρο ή ειδική εγκατάσταση
- + Η χαμηλή θερμοκρασία είναι ασφαλής
- + Υψηλότερης ενεργειακής απόδοσης
- + Ομοιόμορφη θερμοκρασία στο εσωτερικό
- + Σύντομο χρόνο προθέρμανσης (15 λεπτά μονό είναι αρκετά)
- + Δέχεται CD και άλλες βελτιώσεις που κάνουν την παραμονή στη σάουνα υπέρυθρων ευχάριστη.

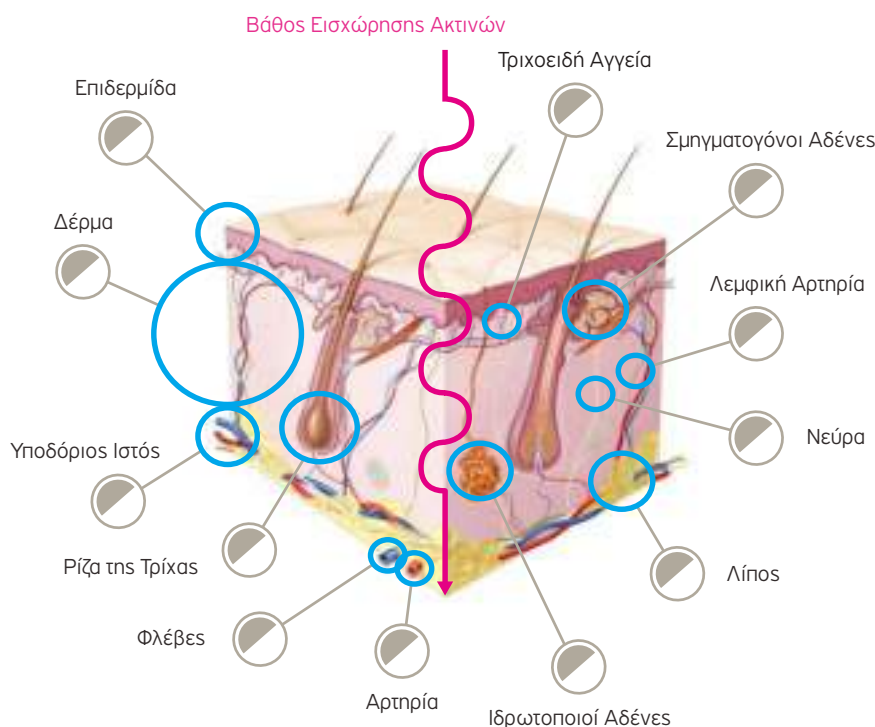

Το κωνοφόρο της βόρειας Αμερικής είναι σκληρό και δύσκολο να συρρικνωθεί, φουσκώσει, στρεβλωθεί και συστραφεί. Αφού αποξηραθεί, σκουραίνει με τη λειτουργία της σάουνας, ωστόσο μπορεί να διατηρήσει το ίδιο χρώμα για χρόνια. Δεν περιέχει ρητίνη και δεν εκπέμπει οσμή. Όλα αυτά το καθιστούν συγκρίσιμο με τον κόκκινο κέδρο.

Ποιά είναι τα πιθανά οφέλη από τις Σάουνες Υπέρυθρων

από μια Συνεδρία 15 λεπτών;

- + **Αποτοξίνωση:** Η σάουνα υπερύθρων προκαλεί διέγερση του οργανισμού και αυτός αποβάλλει με τον ιδρώτα όλες τις λιποδιαλυτές τοξίνες, βαρέα μέταλλα και τοξικές ουσίες.
- + **Ενίσχυση του Ανοσοποιητικού Συστήματος:** Η σάουνα υπερύθρων, προκαλώντας αύξηση της θερμοκρασίας του σώματος, κινητοποιεί το αμυντικό σύστημα του οργανισμού και προκαλεί αύξηση των λευκών αιμοσφαιρίων, ενισχύοντας με τον τρόπο αυτό το ανοσοποιητικό σύστημα του ανθρώπου.
- + **Μείωση των Επιπέδων Στρες και Χαλάρωση:** Διαστέλλοντας τα τριχοειδή αγγεία βελτιώνεται η κυκλοφορία (προκαλείται υπεραιμία), ο οργανισμός απελευθερώνει τις ενδορφίνες, πράγμα που μπορεί να βοηθήσει στη μείωση των και επιπέδων του στρες.
- + **Ελεγχος Βάρους:** Αυτό δεν επιτυγχάνεται με την πρόσκαιρη απώλεια υγρών (ιδρώτας), αλλά είναι δυνατόν να επιτευχτεί και μέσω δυο κυρίως παράπλευρων δράσεων.
 - Η αποβολή των βαρέων μετάλλων σχετίζεται άμεσα με την επιτάχυνση της διαδικασίας μεταβολισμού και την αποφυγή συσσώρευσης λίπους.
 - Το κάψιμο του υποδόριου λίπους, κάτι που ισοδυναμεί με τρέξιμο 3-9 χιλιομέτρων.

Μείωση Στρες - Χαλάρωση +

+ Καθαρισμός και Αναζωογόνηση Δέρματος

+ Ενίσχυση Ανοσοποιητικού

Αποκατάσταση Μυών +

Αποτοξίνωση +

+ Βελτίωση Καρδιακής Λειτουργίας

Ελεγχος Σωματικού Βάρους +

+ Βοηθά στην Μείωση της Αρτηριακής Πίεσης

Εξομάλυνση Επιδερμίδας μειώνει την όψη φλούδας πορτοκαλιού +

- + **Καρδιαγγειακή Λειτουργία:** Στην προσπάθειά του το σώμα να δροσίσει τον εαυτό του, εκτρέπει την κυκλοφορία του αίματος από τα εσωτερικά όργανα προς τα άκρα με την αγγειοδιαστολή. Έτσι, αυξάνονται οι καρδιακοί παλμοί, η παροχή αίματος και ο μεταβολικός ρυθμός.
- + **Βοηθά στον Έλεγχο της Αρτηριακής Πίεσης:** Με τη διαστολή των τριχοειδών αγγείων.
- + **Κυτταρίτιδα:** Η κυτταρίτιδα είναι μια ουσία σαν ζελατίνη που αποτελείται από λίπος, υγρά και απόβλητα που έχουν παγιδευτεί σε θύλακες στον υποδόριο ιστό. Η ταχεία εφίδρωση μπορεί να βοηθήσει ώστε ο οργανισμός να απαλλαγεί από την κυτταρίτιδα, ειδικότερα εάν αυτή η προσπάθεια ενισχυθεί με κατάλληλη διατροφή, μασάζ, ασκήσεις και αγωγή με επάλειψη με ειδικές κρέμες.
- + **Καθαρισμός και Αναζωογόνηση Δέρματος:** Μια συνεδρία σε σάουνα υπερύθρων μπορεί να βοηθήσει στο να ανοίξουν οι φραγμένοι πόροι του δέρματος και να απομακρυνθούν ρύποι, λίπη και άλλα απόβλητα του οργανισμού.

Ο καλύτερος συνδυασμός για ταχύτερα αποτελέσματα είναι η γυμναστική 1as ώρας και έπειτα 15 λεπτά σάουνα

★ Tip

Μετά από μια έντονη προπόνηση μπες για 10 λεπτά στη σάουνα κάνοντας ένα ενδιάμεσο διάλειμμα για να δροσιστείς με χλιαρό νερό.

ΣΥΣΤΗ ΕΠΑΝΑΦΟΡΑ ΜΕΤΑ ΑΠΟ ΚΑΘΕ ΑΣΚΗΣΗ

Χαλαρώστε τους μύες σας καταπραΰνοντας τους πόνους που προέρχονται από αυτούς και τις αρθρώσεις με την απελευθέρωση των ενδορφινών πρωτεϊνών ουσιών. Μειώστε την ένταση και εξαλείψτε το γαλακτικό οξύ και άλλες τοξίνες.

Η βαθιά εφίδρωση στη σάουνα μπορεί να βοηθήσει στη μείωση των επιπέδων μολύβδου, χαλκού, ψευδαργύρου, νικελίου, υδραργύρου και χημικών ουσιών - οι οποίες είναι τοξίνες που συνήθως απορροφώνται μόνο από την καθημερινή αλληλεπίδραση μας με το περιβάλλον.

Καθώς η θερμοκρασία του σώματος αυξάνεται με τη θερμότητα της σάουνας, τα αιμοφόρα αγγεία διαστέλλονται επιτρέποντας αυξημένη κυκλοφορία του αίματος, η οποία με τη σειρά της επιταχύνει τη φυσική διαδικασία επούλωσης του σώματος.

Ποια είναι λοιπόν η κατάλληλη σάουνα για εσάς;

Οι άνθρωποι χρησιμοποιούν σάουνες εδώ και χιλιάδες χρόνια, πολύ πριν μάθουμε για την ύπαρξη του φωτονίου. Για την ακρίβεια πολύ πριν τον ηλεκτρισμό.

Η έκθεση στη θερμότητα έχει αποδειχθεί ένα από τα πιο ισχυρά εργαλεία για τη **διατήρηση της προσωπικής υγείας** και τη **βελτίωση της προπόνησης, της ενδυνάμωσης και της αντοχής**. Παρόλα αυτά, δεν υπάρχουν αξιόπιστα δεδομένα που να υποστηρίζουν ότι ένας τύπος σάουνας είναι καλύτερος από τον άλλο. Υπάρχουν μόνο δεδομένα που λένε ότι το πιο ζεστό είναι -συνήθως- καλύτερο.

Μόνο ανέκδοτες περιπτώσιολογικές μελέτες και μη ερευνημένα υποστηριζόμενα ή αξιολογημένα άρθρα που βγαίνουν συνεχώς έχουν γραφτεί.



Λοιπόν, ναι, υπάρχουν ορισμένες περιπτώσεις ανοσοκατεσταλμένων ατόμων που χρησιμοποιούν υπέρθερες ως συγκεκριμένη μέθοδο θεραπείας με επιτυχία. Όμως, όσον αφορά το μέσο όφελος για τη γενική προσωπική συντήρηση σε μια ρουτίνα ευεξίας, το παραδοσιακό φαίνεται να είναι καλύτερο.

Τα στοιχεία λένε ότι **βιώνετε τα οφέλη της έκθεσης στη θερμότητα σε κάθε περιβάλλον**, αλλά οι υψηλότερες θερμοκρασίες (εάν τις αντέχετε) έχουν κάποια αποδεδειγμένα πλεονεκτήματα.

Σήμερα δεν μπορούμε να πούμε ποιος είναι ο καλύτερος τύπος σάουνας, αλλά μπορούμε να πούμε ότι υπάρχει απλώς η καλύτερη σάουνα για τον καθένα από εμάς. Αυτή δηλαδή που μας αρέσει ή που μας εξυπηρετεί με βάση τις ανάγκες και τους χώρους μας και θα την απολαύσουμε περισσότερο.

46072

- » Bluetooth speaker
- » Clear safety glass 6mm thick
- » Heating panel
- » Wood: Hemlock

SPECIFICATIONS

Dimensions: 90,0x90,0x190,0 cm

Consumption: 1.400 W

Max temperature: ≈65°

Persons: 1

Category: D1



Sauna S-11 Infrared Sauna



Infrared



Bluetooth



Capacity
1 Person



Max temperature
≈65°



Hemlock

46073

- » Bluetooth speaker
- » Clear safety glass 6mm thick
- » Heating panel
- » Wood: Hemlock

SPECIFICATIONS

Dimensions: 120,0x90,0x190,0 cm
 Consumption: 1.800 W
 Max temperature: ≈65°
 Persons: 2
 Category: D1



Sauna S-11

Infrared Sauna



Infrared



Bluetooth



Capacity
2 Persons



Max temperature
≈65°



Hemlock

46074

- » Touch screen
- » 7 color LED strip
- » Stainless steel door handle
- » Bluetooth speaker
- » Clear safety glass 6mm thick
- » Heating panel
- » Wood: Hemlock

SPECIFICATIONS

Dimensions: 150,0x103,0x195,0 cm
 Consumption: 2.320 W
 Max temperature: ≈65°
 Persons: 3
 Category: D1



Sauna S-08

Full Spectrum Infrared Sauna



Infrared



Bluetooth



Capacity
3 Persons



Max temperature
≈65°



LED lighting



Hemlock

46078

- » One-level bench
- » Bucket and Ladle
- » Hygrometer | Thermometer
- » Clear safety glass 6mm thick
- » 20 kg sauna stones
- » Wood: Hemlock

SPECIFICATIONS

Dimensions: 150,0x110,0x200,0 cm
 Consumption: 4.500 W
 Max temperature: ≈70-80°
 Persons: 2
 Category: D1



Sauna NYS-171

Traditional Sauna



Traditional



Max temperature
≈70-80°



Capacity
2 Persons



Hemlock

- ✓ Adjustable back and seat. The back can also tilt.
- ✓ My grabbing the special knob, you can change the height of the seat, without even having to stand.
- ✓ The seat/back rests are made from double density foam material: soft on top and firmer at the bottom. The unique design of the back offers the right support, while at the same time decreasing the pressure on the spine.
- ✓ Abdominal exercises.
- ✓ Aren't 90kg enough for you? Simply connect the special cables and the resistance doubles!
- ✓ The bearings, hermetically sealed and lubricated, offer extremely smooth usage.
- ✓ Design that allows placement next to a wall.
- ✓ The side arms mimic the sensation of exercising with free weights and enable the execution of special exercises for various sports.
- ✓ Adjustable position of the legs to perform the relevant exercises.
- ✓ Only *Elite* allows you to exercise with the feel of free weights, but with the safety of a multi-gym.

Elite

44723

Elite

44724

Leg Press

combined with
44723

Weight
50kg

177×215(158)×210cm

(The number in parentheses is without the Leg Press)

PL weight
90/180kg

Weight
178kg

Category
D5

12 adjustments enabling the implementation of all exercises



44738

GXP

44739

Leg Press

combined with
44738

Weight
49 Kg

210(165)×166×208cm
(The number in parentheses is without the Leg Press)

PL weights 19 pcs.	PL weight 90/180Kg	Weight 171 Kg	Category D5
-----------------------	-----------------------	------------------	----------------



- ✓ Adjustable back and seat. The back can also tilt.
- ✓ My grabbing the special knob, you can change the height of the seat, without even having to stand.
- ✓ The seat/back rests are made from double density foam material: soft on top and firmer at the bottom. The unique design of the back offers the right support, while at the same time decreasing the pressure on the spine.
- ✓ Abdominal exercises.
- ✓ Aren't 90kg enough for you? Simply connect the special cables and the resistance doubles!
- ✓ The bearings, hermetically sealed and lubricated, offer extremely smooth usage.
- ✓ Design that allows placement next to a wall.
- ✓ The side arms mimic the sensation of exercising with free weights and enable the execution of special exercises for various sports.

12 adjustments
enabling the
implementation
of all exercises

X-Press PRO



44742

- > Adjustable back and seat, the back can also tilt, from high density foam material, 5 cm thick
- > **Frame:** 5x5 & 5x7,5 iron tubes
- > **Pulleys:** Diameter 11,5cm, nylon and fiberglass, with hermetically sealed and lubricated bearings
- > **Cable:** Extremely flexible, nylon covered, more than 900kg endurance
- > **Weights:** 20 pcs. iron plates with nylon bushings
- > **Guides:** Chromed 2.5 cm

Semi-Commercial Grade

PL weights 19 pcs. PL weight 90 Kg
Weight 167 Kg Category F1



Leg Press

44726

combined with 44742

12 adjustments enabling the implementation of all exercises

144x211x211cm

44736

GX

> WITHOUT the Leg Press

Semi-Commercial Grade

- ✓ Adjustable back and seat. The back can also tilt.
- ✓ Abdominal exercises.
- ✓ The bearings, hermetically sealed and lubricated, offer extremely smooth usage.
- ✓ Design that allows placement next to a wall.

> Leg Press

12 adjustments enabling the implementation of all exercises

44737

Leg Press

combined with 44736

Weight 41,7 Kg

188(133)x192(138)x213cm
(The number in parentheses is without the Leg Press)

PL weights 14 pcs. PL weight 90-95 Kg Weight 134 Kg Category D5



44743

Semi-Commercial Grade

GL

IFHC

Half Cage
IFHC

Adjustable back and seat. The back can also tilt



PL weights 19 pcs. PL weight 90 Kg Weight 114Kg Category D5

138x133x211cm

Weight 100 Kg Max Weight 200 Kg Category F1



169x173x209cm

IFHCL

Half Cage Lat Attachment
IFHCL

IFHCS

Half Cage Smith Attachment
IFHCS

IFHCP

Half Cage Pec Fly Attachment
IFHCP



Weight 41 Kg Category F1

180x40x210cm



Weight 33 Kg Endurance 200 Kg Category F1

195x30x173cm



Weight 24,3 Kg Category F1

95x36x154cm

44710



JONES PLATINUM

For the person insisting only for the best! In contrast to a typical Smith machine, Jones Platinum offers patented technology, allowing horizontal and vertical movement. The addition of Active Balance bar offers a truly unique free-bar experience.

- Safety spotters that move with you
- Entirely natural feeling
- Use the Olympic bar of your choice
- Many accessories available
- 5 different traditional Smith exercises

The **Full Body Trainer (FBT)** dual cable columns provide for the very best Functional Training, Sports Specific Training and Body Building exercises. The FBT combined with the Jones Platinum offers an almost infinite number of adjustments and exercises. The FBT can be used as a traditional Functional trainer, or can be used in concert with the Jones Platinum to offer a multitude of Stretch Training exercises, Body Weight exercises or Progressive Functional Training exercises™. Progressive Functional Training allows for adjustable degrees of muscular involvement, from engaging the entire body, to isolating specific muscle groups.

FEATURES

- **Body Weight Training:** Two different chin bars (multi-angle in the front and straight bar in the rear) provide every possible grip for chin-ups and pull-ups. Fix the Olympic Bar into various positions for angled push-ups, pull-ups, leg exercises and more. The Jones Platinum will accept your own Hanging Ab Straps, or Adjustable Training Straps.
- **Stretch Training:** The bars and handles can be fixed into dozens of positions for a myriad of stretches.
- **Functional Training:** The FBT is a Full Body Training machine providing Strength training for the way humans are designed to move! Dual weight stacks provide up to 200 pounds of combined resistance and 80 inches of travel.
- **Progressive Functional Training:** Combining the Jones Platinum and the FBT enhances the variety of exercises that can be performed.
- **Barbell Training:** All Barbell Exercises can be performed with the safety of the bar hooks and safety spotters moving along with you!
- **Sports Specific Training:** The FBT also provides Sports Specific training.
- **Smith Machine Training:** The Jones Platinum can be locked into place to become a Smith Machine.



Category
F1



44711

FBT (FULL BODY TRAINER)

- Adds hundreds of exercises to Jones
- 32 different height settings for the grips
- Progressive functional training
- Accessories: Long bar, Multi-position handles, Add-on weights, Optional progressive functional pad

Category
F1

SPECIFICATIONS

- **Construction:** Heavy duty steel
- **Movement:** All moving parts utilise industrial quality linear LM25 bearings and bars of hardened steel
- **Active Balance Bar:** From 25 until 454 kgs strength
- **Dimensions:** 137x215x213cm or, with the addition of FBT, 188x215x213cm

44712

- **At any point** during an exercise the weight bar can be “racked” with a simple twist of the wrist. Adjustable safety spotters are included to add that extra measure of security
- **Easy Transitions:** Simply raise or lower the bar to the desired starting position, adjust the safety spotters to a safe position, add the desired weight, and lift!
- **Hooks and safety spotters** travel with you
- **Can be locked** for traditional Smith Machine exercises
- **Includes Chin-Up Bar**



Category
F1

112x140x211cm



44713

- **PLATE RACK**
 - Bolts directly onto the back
 - Features a total of 12 solid chrome Olympic weight Holders



- > **11 Lockout positions** for hooks and safety spotters at 4½” intervals
- > **Movement:** All moving parts glide smoothly on industrial grade linear bearings and solid hardened steel guide rods
- > **Choose** the Olympic Bar you want

44714

- > **11 Lockout positions** for hooks and safety spotters at 4½” intervals
- > **Movement:** All moving parts glide smoothly on industrial grade linear bearings and solid hardened steel guide rods
- > **Choose** the Olympic Bar you want
- **Includes Chin-Up Bar**
- **Can be locked** for traditional Smith Machine exercises

Additional optional parts



4471402

- **CROSSOVER**
 - Two independent 200lb weight stacks provides 2:1 ratio
 - 18 different cable positions on each column
 - Provides hundreds of different exercises
 - Includes ankle strap and two single handles
 - Weight stack guards included

4471401

- **LAT OPTION**
 - 200lb weight stack provides 1:1 ratio
 - High-pull and low-pull station
 - Weight stack guards included
 - Includes Lat-Pull Bar and a Curl / Row Bar



44713

- **PLATE RACK**
 - Bolts directly onto the back
 - Features a total of 12 solid chrome Olympic weight Holders



Category
F1

107x139x211cm

44741

Jones Freedom

The most Affordable member of the Jones family

Our patented barbell motion provides for an almost unlimited array of exercises. Smith Machines only move vertically, not allowing for natural body movement. The Jones moves both vertically and horizontally, allowing for unlimited, user-defined motion. Because the body's natural movements can be utilized within the Jones, all free weight exercise can be performed. The Jones Freedom comes standard with a bar.

- **At any point** during an exercise the weight bar can be "racked" with a simple twist of the wrist. Adjustable safety spotters are included to add that extra measure of security
- **Easy Transitions:** Simply raise or lower the bar to the desired starting position, adjust the safety spotters to a safe position, add the desired weight, and lift!
- **Hooks and safety spotter** travel with you
- **Can be locked** for traditional Smith Machine exercises



- › Olympic bar, 40lbs weight, capacity of 500lbs
- › **20 Lockout positions** for bar and safety spotters with 3 inch spacing
- › Commercial grade precision **linear bearings** for smooth action
- › Case-hardened, precision milled stainless steel **guide rods**
- › **Dark gray** powder coat finish



Category
F1

126x140x211cm

44715

Combine three machines into one!

F660 (Linear Bearing Hip Sled)

Foot press and Hack-Donkey Squat with a maximum load of 454kg



- › **Squat shoulder pads:** Unlike other machines, our oversized squat shoulder pads are fully adjustable, accommodating a wider range of users
- › **Foot Plates:** Both upper and lower foot plates adjust to several different angles. Upper plate measuring 16" L x 24" W and lower measuring 17" L x 24" W
- › **Donkey Squat Pad:** Allows for squats and calf raises by pressing with lower lumbar, relieving spinal compression
- › **Industrial grade linear bearings:** Never flatten and are next to impossible to wear out, ensuring smooth consistent performance for as long as you own the machine
- › **Space saving design:** With weights loading under the carriage
- › **Construction:** Using heavy gauge, 2" x 3" steel tubing and 1/4" plate steel
- › **Carriage:** Rides on industrial grade Linear Bearings, and 1.25" case hardened steel solid guide rods. 75 lb. starting weight
- › **All pads:** Use double stitched heavy duty upholstery and high density foam
- › **Leg press back pad:** Features lumbar support and flips up on a hinge for hack squat
- › **Squat, Shoulder and Leg Press pads:** Permanently attached for convenience and longevity
- › **Diamond skid hack squat plate:** Allows for multi-position foot placement and can be adjusted to 5 different angles
- › **Weight Capacity:** 454kg

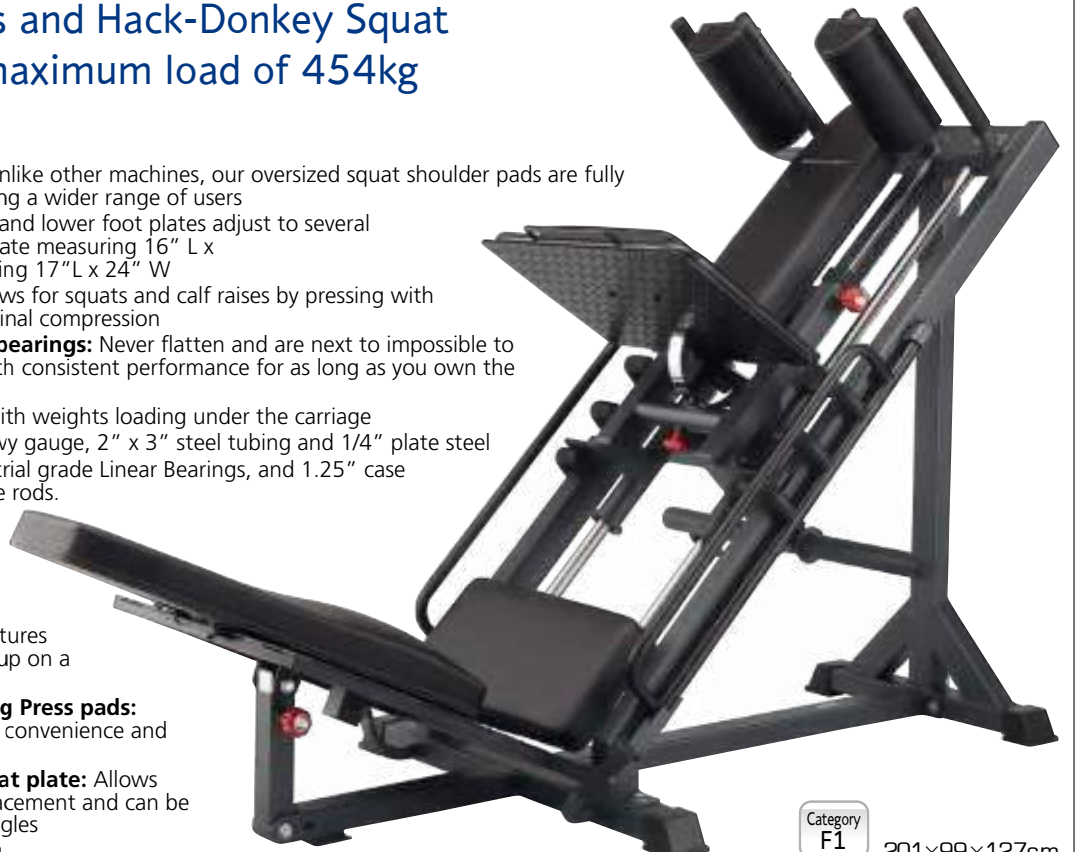

Category
F1

201x99x127cm

44709

Commercial Grade

- > **Tube:** Oval 8,26x4,45mm
- > **Pulleys:** Ø10cm fiberglass with sealed bearings
- > **Cables:** Nylon covered, capable to endure more than 900kg
- > **Weights:** 2 autonomous columns covered with acrylic panels, 72.5kg each, offering resistance in relation to the chosen weight of ratio 2:1
- > **Guides:** Chromed Ø2,54cm
- > **Accessories:** Exercise book, Long bar, Short bar, Pull bar, Pull straps, Abdominal harness, Ankle straps, Single grips

+ Amazingly smooth movement



- > Pulleys that rotate 180 degrees and follow the movement of the body for even more natural movement.
- > The pulleys are adjustable throughout the whole height range, so that you can immediately switch to another exercise with easy and quick change of the height of the pulley using just one hand

Category F1



Dual Adjustable Pulley PFT

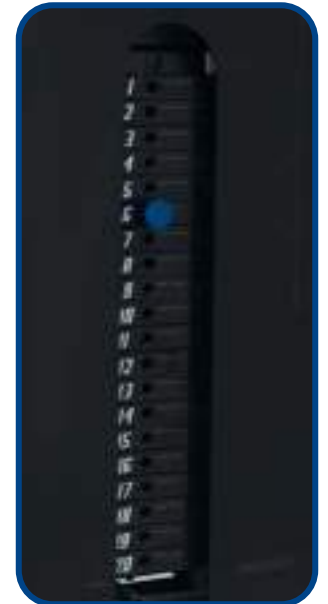

- > 145kg weight plates divided into 2 autonomous columns of 72.5kg each

211x135x102cm

44717

Semi-Commercial Grade

- > **Tube:** Oval 8,26x4,45mm
- > **Pulleys:** Ø9cm fiberglass with sealed bearings
- > **Cables:** Nylon covered, capable to endure more than 900kg
- > **Weights:** 2 autonomous columns covered with acrylic panels, 90kg each, offering resistance in relation to the chosen weight of ratio 2:1
- > **Guides:** Chromed Ø2,54cm
- > **Accessories:** Exercise book, Long bar, Short bar, Triceps rope, Pull bar, Pull straps, 2 chains, Ankle straps, Single grips



Dual Adjustable Pulley HFT



Category F1

142x102x208cm

91640

Semi-Commercial Grade

Dual Adjustable Pulley FT3100

AMILA®

- > **Tube:** 40x80x2.0mm heavy duty construction tube
- > **Cables:** 2000lbs tensile strength aircraft cables
- > **Weights:** 2 x 50kg commercial grade steel stack
- > **Max user weight:** 180kgs
- > **Accessories:** Long bar, Short bar, Triceps rope, Pull grips, 3 chains, Single grips, Soft grips



Weight 234kg Category F1

105x188x223cm

IFFT

Semi-Commercial Grade

Dual Adjustable Pulley IFFT

in impulse

- > **Weights:** 2 x 91kg commercial grade
- > **Accessories:** Long bar, Short bar, Triceps rope, 2 different pairs of grips



Weight 236kg Category F2

90x180x213cm

HG5

Cable Motion Gym
HG5

The Cable Motion Gym Pulley System is a very useful fitness equipment that offers a comprehensive workout without taking up too much space, making it ideal for a hotel or small STUDIO.



With the 6 handles (2 high, 2 in the middle and 2 low), the user has the ability to fully exercise his whole body. It is an instrument very easy to use which, with proper guidance from a fitness trainer, offers the desired results, above all safely, and is recommended both for the beginner who is just starting and wants a stable, controlled trajectory in the movement of the exercise, as well as for someone more specialized who wants to target a specific part.

Weight 202kg PL Weights 73kg Category F1

145x134x213cm

44733

CFT

EXTREMELY COMPACT, FULL BODY STRENGTH TRAINING

- The Dual Pulleys move up and down on a counter-balanced system and are positioned in a wide format
- 4:1 cable ratio for smooth action and greater range of motion make this machine ideal for Speed Training

FEATURES

- Functional Trainer Accessories: Poster, 2 Single Handles, Ankle Cuff, and 2 Chains.
- Functional Trainer Cable Column Pulley: Independent, counterbalanced adjustable cable column pulleys with 32 height positions that rotate allowing you to train from every angle and any height.
- Compact: Can be placed in any corner of the room.
- Construction: Oval/Round heavy gauge steel tubing, tough diamond gray and textured black powder coated finish, sleek laser cut plates, chrome uprights, laser etched, and attention to the smallest details all add up to an overall exceptional aesthetic appearance.
- Cables: The cable travels 180" when using a single pulley or 90" when using both, and are constructed of flexible nylon coated, 7 X 19 strand aircraft cable rated at over 2000 lbs. tensile strength.
- Pulleys: 3.5" diameter, fiberglass impregnated nylon pulleys with sealed ball bearings.
- Guide Rods: Chrome plated 1" diameter tubular steel.
- Warranted for: Light Commercial and home use.
- Weight Stack: 200lbs. The weight stack to user weight ratio is 4:1 providing up to a total of 37.5 lbs. resistance allows for extremely smooth action, 2.5lb increment weight increases, and greater range of motion. Connect both Cables together with the included chains for up to 75lbs of resistance. (100lbs with the add-on weight)



Weight 152kg	PL Weights 90 Kg	Category F1
-----------------	---------------------	----------------

44732

CPS

THE MOST COMPACT OF ALL

- The Dual Pulleys move up and down
- Suitable for any small area
- 4:1 cable ratio for smooth action and greater range of motion make this machine ideal for Speed Training
- Connect both pulleys with the included chain for a 2:1 cable ratio

FEATURES

- Easy accessibility; also suitable for wheelchair users
- Bracket frames are integrated to drill on the wall for more stability
- Functional Trainer Accessories: 2 Single Handles, Ankle Cuff
- Pulleys: Ball bearings for smooth power transmission, can be adjusted in 32 different positions and rotate fully so that you can actually move from any angle at any height
- Weight Stack: 200lbs. The weight stack to user weight ratio is 4:1 providing up to a total of 37.5 lbs. resistance allows for extremely smooth action, 2.5lb increment weight increases, and greater range of motion. Connect both pulleys together to double resistance



Weight 152kg	PL Weights 90 Kg	Category F1
-----------------	---------------------	----------------

53,6×60,7×202,7cm

44718

The BodyCraft Power Rack is built for the person who knows how to push their body to the limit. Rugged construction and easy adjustments make your workout enjoyable and quick. Adjustable Spotter Arms are included for safe, solo workouts.

Chin bar: Allows for use with inversion boots, hanging ab straps, bands, etc.



J-hooks and Spotters: High-density rubber securely screwed down, prevents scratching

Frame: Rugged heavy gauge 50x75mm steel tubing, 3mm thick



2" spacing between each adjustment point, laser-etched numbers

Pop-pins: Easy to adjust and always out of the way of your bar

Working space: 109x87,5cm

130x124x210cm

Weight 87kg Capacity 450kg Category F2

44735

Power Strength Row
Connects to existing low-cable

- > **Material:** Powder-coated steel
- > **Track:** Heavy duty steel mono-rail beam
- > **Foot hold:** Fixed steel footrest with velcro foot straps
- > **Support legs:** Steel legs with end-caps to protect your floor and prevent movement
- > **Seat:** Contoured comfort seat with heavy duty roller bearings, 26,25-31,50cm height
- > **Seat movement:** 100cm
- > **Max user height:** 195cm
- > **Max user weight:** 159kg

- **IT MUST BE CONNECTED** to an existing low-cable
- It allows for **faster** and **smoother reps** for an increased cardiovascular workout
- **High-performance** easy glide **seat wheels** for smooth long-lasting performance
- **Transport wheels** allow for easy placement and storage



Weight 15,4kg Category F1

177x50x31,5cm

RFT Functional Trainer

(For F430 Power Rack)

44729

- > **Frame:** Heavy gauge oval steel tubing. The powder coated finish evenly coats all surfaces, tough and long lasting.
- > **Pulleys:** Diameter 8,9cm, fiberglass impregnated nylon pulleys with sealed ball bearings
- > **Cable:** The most flexible nylon coated, 7 x19 strand aircraft cable rated at over 900 kg tensile strength

Our Rack Functional Trainer (RFT) option is built for MAXIMUM flexibility and safety. Expand the exercises that you can perform with your F430 Power Rack by adding this 6 Pulley Option.

Virtually every strength training option is available with this versatile and compact system. The 6 swivel pulleys allow for movement along multiple planes, and dual weight stacks greatly increase the number of exercises that can be performed.



BRING IT DOWN – The RFT features dual independent swiveling high pulleys mounted at the top rear of the back. These can be used in conjunction with the included lat bar or single handles. Work your shoulders, back, arms and more!



Accessories:
Long lat bar, Row/curl bar,
Ankle strap, 2 single handles,
2 chains



FUNCTIONAL FRONT – Dual front adjustable swiveling pulleys with 23 height positions. Adjust the pulley height by simply releasing the pop-pin and sliding the pulley to the desired position. The laser etched numbers on the inside of each upright will make sure both pulleys are at equal heights.

Guide rods:
Chrome plated
2,54cm diameter
tubular steel



Weight stack:
Dual 91kg each,
with magnetic
selector pins and
stack to user
weight ratio
being 2:1

GET LOW – In the rear of the RFT are dual independent low pulleys. This station is ideal for rows, bicep curls, ab exercises, etc.



Weight
260kg

Category
F2

165x150x211cm

44706

Commercial Grade

Bench F320

- > **Tube:** Square 50x75mm
- > **Pillow:** 5cm high density foam material for support, 1,25cm low density foam material on the top for comfort
- > **Incline:** 8 positions (20°, 0°, 15°, 30°, 38°, 45°, 60°, 70°)
- > **Height:** 51cm when horizontal, making him ideal for exercises with dumbbells



Strength 450Kg Category F1

159x53x53cm

44701

Arm Curl Attachment
Suitable for both of the benches above

- Ergonomically designed comfort pad
- Pop-pin Adjustable Bar Catch (Can be removed for certain applications)



44708

Commercial Grade

Bench F602

- > **Tube:** Square 50x76mm
- > **Pillow:** High density foam material inside, 5cm thick offering support, topped with low density 1,25cm thick foam material for added comfort
- > **Incline:** 7 positions
- > **Endurance:** 450kg
- Transport wheels



Strength 450Kg Category F1

62x157x50cm

44702

Leg Curl/Extend Attachment
Suitable for both of the benches above

- Locking leg hold down
- 6 roller design
- Weight peg accepts standard (Ø28mm) disks

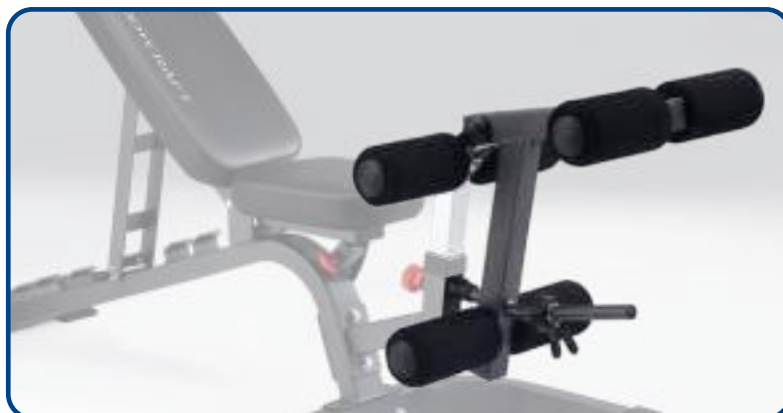

44707

Commercial Grade

Bench F603

The ideal complement to PFT

- > **Tube:** Square 50x76mm
- > **Pillow:** 5cm high density foam material for support, 1,25cm low density foam material on the top for comfort
- > **Incline:** 8 positions (0°- 85°)
- Transport wheels
- Its low height (46cm) makes him ideal for exercises with dumbbells
- The back can be adjusted vertically (8 positions)



Strength 350Kg Category F1

72,4x127x45,7cm

44703

Commercial Grade

Bench F600

- > **Tube:** 50x75mm & Ø75mm
- > **Pillow:** High density 5cm
- > **Height:** 45cm, making him ideal for exercises with dumbbells
- Transport wheels



Category F1

72x122x44,5cm

44716

F670 (Roman Chair With Hyperextension)



- > **Construction:** 2" x 2" square, heavy-gauge steel
- > **Incline:** Adjusts from 0, to 25, to 45 degrees
- > Fully adjustable Πλήρως ρυθμιζόμενα foam pads and foot plate
- > Fully adjustable roman chair, accommodated all size users
- > Extra wide injection molded pad is comfortable for both men and women
- > Exercise guide included for your convenience
- > Handle bars for safe entry and exit

Category F1

129,5x61x96,5cm

44704

Commercial Grade

Bench F680

- > **Tube:** Square 50x50mm
- > **Pillow:** 5cm high density foam material for support, 1,25cm low density foam material on the top for comfort
- > **Incline:** 16 positions (19°-46°)
- Rotating caps for easy transport



Category F1

63,5x152x145cm

IFFID

Multi-Purpose Bench

IFFID

Semi-Commercial Grade



Weight 33 Kg Category F1

158x65x52cm

IF45

45-Degree Hyperextension

IF45

Semi-Commercial Grade



Weight 23,5 Kg Category F1

121x74x77cm

IFAAB

Adjustable Abdominal Bench

IFAAB

Semi-Commercial Grade



Weight 24 Kg Category F1

168x57x115cm

IFRC

Roman Chair

IFRC

Semi-Commercial Grade



Weight 30,5 Kg Category F1

136x74x109cm

IFSPC

Seated Preacher Curl

IFSPC

Semi-Commercial Grade



Weight 24,7 Kg Category F1

102x71x82cm

IFAC

Abdominal Crunch
IFAC

Semi-Commercial Grade



Weight
17 Kg

Category
F1

110x48x58cm

IFFB

Flat Bench
IFFB

Semi-Commercial Grade



Weight
19,5 Kg

Category
F1

131x53x49cm

IFUB

Utility Bench
IFUB

Semi-Commercial Grade



Weight
12,7 Kg

Category
F1

86x60x87cm

IFCC

Semi-Commercial Grade



Weight
291 Kg

PL Weights
2x68 Kg

Category
F1

366x104x212cm

Cable Crossover
IFCC

IFPT

Power Tower
IFPT

Semi-Commercial Grade

inimpulse



Weight
77 Kg

Category
F1

132x61x211cm

93701

Semi-Commercial Grade

Seated Calf Raise Machine

- Adjustable over-sized pads.
- Easy pull pin to adjust height and distance in seconds.
- Laser cut checker foot plate enables different start positions.
- Adjustable knee pad for correct alignment during your exercise.
- Can use Standard and Olympic Weight plates - comes with a weight plate adapter.
- Includes built in safety catches for added safety during your workout.



Category F1

127×52×45cm

93702

Semi-Commercial Grade

Adjustable Hyper Extension

- Easy pull-pin to adjust height and distance in seconds.
- Made to suit all user heights.
- Fully adjustable from 45° to 90° for optimal results and correct alignment during your exercise.
- Adjustable foot holders for correct positioning.



Category F1

150×93×96cm

93703

Semi-Commercial Grade

Leg Extension

- Adjustable over-sized pads.
- Adjustable and removable leg hold-down rollers to give you maximum comfort.
- Easy pull-pin adjustment to switch from leg extension to leg curls in seconds.
- Laser cut range-of-motion adjustments enables multiple start positions.
- Includes a lock catch to enable legs to be locked in place for abdominal workouts.
- Can be used with both Standard and Olympic Weights.



Category F1

160×127×128cm

93704

Semi-Commercial Grade

Adjustable Olympic Bench Press

- Made from high quality materials, ensuring durability and comfort
- It allows for decline, flat and incline bench press.



Category F1

150×125×147cm

93707

Vertical Knee Raise Dip Pull-Up Station

- Gives you the ability to do chin-ups, dips, push-ups, sit-ups and leg raises
- Angled back pad for added comfort whilst performing leg raises

- Multiple grip positions for pull-ups, dips and push-ups
- Contoured arm rests for secure positioning
- Leg holder for solid ab workouts and sit-ups

Semi-Commercial Grade



Category F1

158x125x211cm

91600



Semi-Commercial Grade

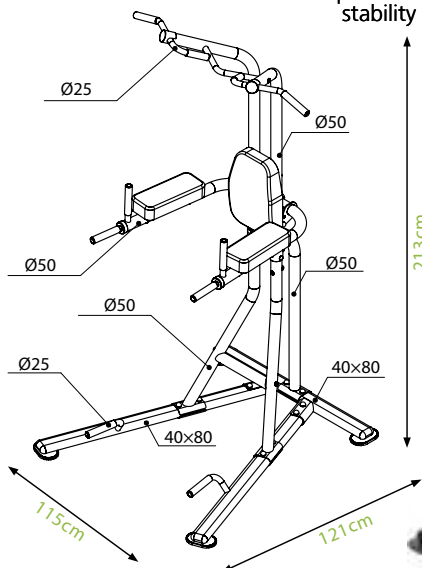

SCAN HERE to view the Assembly Video on our YouTube channel.

Category D7

The slight inward inclination of the pillows increases the stability of our arms

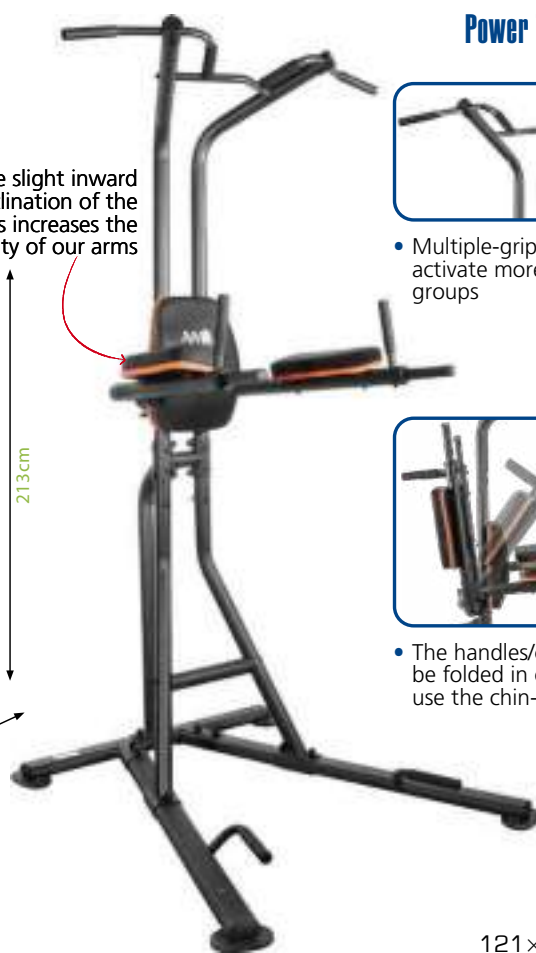

Power Tower PT550



- Multiple-grip chin-up to activate more muscle groups



- The handles/cushions can be folded in order to freely use the chin-up

121x115x213cm

44274

Power Tower AMILA®

Semi-Commercial Grade

- > **Tube:** 50x70x1.5mm
- > **Pillow:** EPE inside, covered by 1mm PU



Weight 41 Kg

Category F1

112x112x221cm

44273

- > Absolutely stable

Chin-up Rack

HOME USE



Weight 35 Kg

Category D7

136x108x217cm

HOME GYM HG650



You can use the Pec Deck to perform chest presses by locking it in place using a safety pin.

With vinyl covered 55Kg weight stack, surrounded by metal mesh for increased safety while exercising

91209

SPECIFICATIONS

Dimensions: 185,0x105,0x203,0 cm

Tubes: Heavy duty 50x50x1,5 mm

Cables: Aircraft type (2000LBS)

Pads: High-quality, anatomic, 50 mm thick

Stack weight: 55 Kg

NET weight: 125 kg

Max user weight: 135 kg

Category: D7



Scan the QR and watch the assembly video of HG650



Learn more about HG650 at www.amila.gr or scan the QR

Home Gym HG1200

91204

- > **Tube:** 50x50x1.5mm heavy duty construction tube
- > **Seat wood:** 12mm thick
- > **Seat pad:** 50mm thick
- > **Back pad:** 50mm thick
- > **Cables:** 2000lbs tensile strength aircraft cables
- > **Weights:** 205LB vinyl weight stack (13pcs x 15lbs + 1pc x 10lbs)
- > **Max user weight:** 135kgs



SCAN HERE  to view the Assembly Video on our YouTube channel.



Multiple functions of the pec deck

By adjusting the **pec deck** to the proper position, you can use it for **chest presses** and **back pulls**, taking advantage of all the different functions that the **HG1200** gives you.



Includes a wide variety of grips/handles/bands to meet all your training needs



183,2×106,9×213,9cm

Weight **150kg** Category **D7**

91201

- > **Tube:** 50x70x1.5mm
- > **Weights:** 150LB vinyl weight stack
- > **Seat wood:** 12mm thick
- > **Seat pad:** 50mm thick
- > **Back pad:** 50mm thick
- > **Max user weight:** 136kgs



SCAN HERE  to view the Assembly Video on our YouTube channel.



Adjust the butterfly arms to your body type



Adjustable distance of the foam rollers from the seat

By releasing the cable from the leg stretch, the seat and leg stretch mechanism can be lifted together and anchored to the top of the butterfly arms using the supplied chain, so as to be able to use the lower pulley and cable to perform a wide range of exercises.



Reinforced bearings and high-strength 2000lbs cables.



Weight **134kg** Category **D7**

Home Gym DS915

132,5×93×206cm

91202

- > **Tube:** 50x50x1.5mm heavy duty construction tube
- > **Cushions:** 5cm thick
- > **Cables:** 2000lbs tensile strength aircraft cables
- > **Weights:** 148LB vinyl weight stack (14pcs x 10lbs + 1pc x 8lbs)
- > **Max user weight:** 125kgs

Leg-Press – Preacher-Pad

The AMILA HG1187 Multi-Gym allows you to choose between using a preacher-pad or leg-press on the front, the one that you are not currently using can be placed on the receptacle at the back.



SCAN HERE to view the Assembly Video on our YouTube channel.

You can use the Pec Deck to perform chest presses by locking it in place using a safety pin.



EXTRA HANDLES/GRIPS

Extra handles/grips are included, in order to meet all your training needs.

104×186×202cm

Weight **125kg** Category **D7**

91203

- > **Tube:** Ø60mm
- > **Weights:** 98Lbs
- > **Seat wood:** 12mm thick
- > **Seat pad:** 50mm thick
- > **Seat dimensions:** 35x40cm
- > **Seat height:** 47cm
- > **Back pad:** 50mm thick
- > **Back dimensions:** 29x62cm
- > **Butterfly arms max width:** 94cm
- > **Lat bar max height:** 180cm
- > **Max user weight:** 125kgs



Home Gym HG187F



SCAN HERE to view the Assembly Video on our YouTube channel.



Weight **87kg** Category **D7**

133×104×201cm

Home Gym HG250

91210

- > **Tube:** 45x1.5mm heavy duty construction tube
- > **Cushions:** 5cm thick
- > **Cables:** 2000lbs tensile strength aircraft cables
- > **Weights:** 44,5kg (10pcs)
- > **Max user weight:** 120kgs



SCAN HERE  to view the Assembly Video on our YouTube channel.



Category D7

Home Gym HG400

91208

- > **Tube:** 50x50x1.5mm heavy duty construction tube
- > **Seat wood:** 12mm thick
- > **Seat pad:** 50mm thick
- > **Back pad:** 50mm thick
- > **Weights:** 138LB vinyl weight stack
- > **Max user weight:** 125kgs



SCAN HERE  to view the Assembly Video on our YouTube channel.



Weight 113kg

Category D7

170x100x198cm

46437

- > **Designed for:** Full 360 degree rotation
- > **Safety:** It is recommended to use at least one 20kg disk or more
- > **Compatibility:** Olympic disks - Olympic bars
- > **Material:** Iron

*The pictured bumper plate is not included

SPECIFICATIONS

NET weight: 4,5 kg
Category: F1



Post Landmine

AMILA Post Landmine offers a portable solution without any restrictions, offering a full 360 degree rotation for athletes, coaches and people trying to save space while training. Insert the Post Landmine in a bumper plate's hole or any other Ø50 Olympic type disk and begin your workout with safety.

46432

SPECIFICATIONS

Category: F1



Renegade Stand

Bar stand used when inserting disks for Landmine Pivot 360°

46107

* The pictured bumper plates are not included

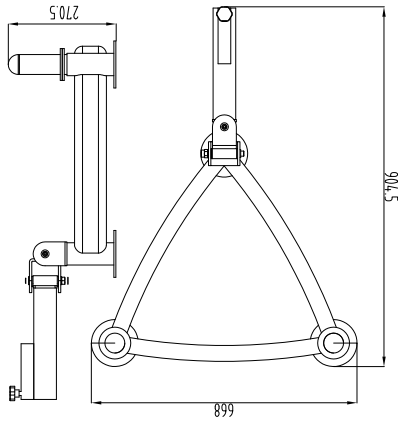

5 basic Landmine exercises

- Landmine Squat
- Landmine Thruster
- Rotatioanal Single - Arm press
- Landmine Antirotation
- Split Squat - Row combo

SPECIFICATIONS

NET weight: 14 kg
Category: F1



Landmine Pivot 360°

Autonomous Landmine, when you don't have a Power Rack

Landmine exercises are more gentle than barbell exercises and effectively exercise all muscle groups.

46433

Wishbone



46434

Clean & Jerk



46439

Wide grip



46438

Narrow grip



46440

Single grip



Landmine Grips

46110

Super Hex Trap

Single Grip

- > One antiskid handle, 25mm diameter
- > Big disk receptors
- > 4 stabilizers
- > Distance between handles: 70cm
- > **Frame:** 50x50x3mm

+ High endurance for many years of professional use



Weight 24 Kg Category F1

168x80x29cm

46142

Hex Trap Bar

Single grip

- > One antiskid handle, 32mm diameter
- > Big disk receptors, 41cm length
- > Distance between handles: 63,5cm
- > **Frame:** 38x38x3mm

+ High endurance for many years of professional use



Weight 27,2 Kg Category Φ1

225x72x22cm

46101

Super Hex Trap

Triple Grip

- > Three rotatable antiskid handles of different diameters
- > Big disk receptors
- > 4 stabilizers
- > Distance between handles: 70cm
- > **Frame:** 50x50x3mm

- + The best HEX TRAP around
- + Heavy duty with high functionality (different diameter handles)
- + High endurance for many years of professional use



Weight 24 Kg Category F1

168x80x29cm

46108

Farmers Walk Handles

- > **Tube:** 50x50mm
- Rubber ball heads on the base



Category F1

43909

- > **Tube:** 70x50x3mm
- > **Friction material:** Rubber

- The best sled available
- Top quality, extremely sturdy construction for demanding continuous commercial use for many years to come
- All accessories are included
- Incorporates all types of movement feasible when exercising with a sled
- 3 different push options
- Pulling and lifting exercises
- Central weight support pole

- Lifting and rolling accessory

- Pull accessory



Weight **74Kg** Category **F1**

! The packaging consists of 3 boxes, with a total weight of 80,5kg

- 4 push accessories

202x64x95cm

43911

- > **Tube:** 70x50x3mm
- > **Harness:** Included
- > **Friction material:** PE

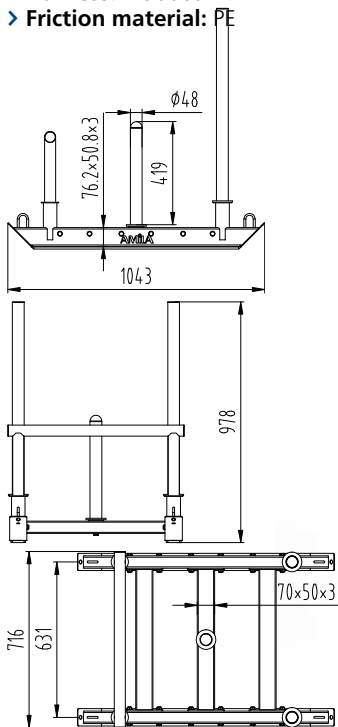

Weight **40,5 Kg** Category **F1**



104x70x98cm

Sled

43915

FULL Commercial Grade

GHD Bench

- > **Material:** Steel
- > **Main tube:** 75x50x2.3mm
- > **Seat:** 450x260x221mm, outer material 1,2mm thick, inner material regenerated sponge, medium foam sponge & plank, upholstered in vinyl

- **Easy to adjust** using a single pop-pin

- + **Heavy-duty construction**
- + **Fully customisable**
- + **PU pillow with reinforced cover**



Weight 70Kg Strength 150Kg Category F1

202x108x110cm

46109

Glute-Ham Developer

- > **Main tube:** 60x60x3.0mm & 50x50x3.0
- > **Seat:** 500x320x160mm, outer material 1,2mm thick, inner material regenerated sponge, medium foam sponge & plank



Weight 38Kg Strength 150Kg Category F1

135x80x100cm

95309

Crossfit TireFlip 180°

- > **Main tube:** Oval 80x50x2,5mm
- > **Material:** Steel
- > **Xtra weight:** Maximum 2x10Kg on each receptacle (disks not included)

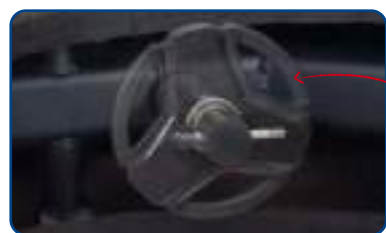

+ Bearings for safe rotation

+ Variable weight with disks



+ Transport wheels



+ Designed with space in the middle for free movement of the legs, eliminating the risk of slipping/tripping

+ Can be bolted to the ground

Weight 125Kg Tire 44Kg Category F2

116x162x54cm



SAFE TRAINING

Enjoy training without limits and without fearing getting injured



ADJUSTABLE HEIGHT

Only AMILA GluteMaster can be adjusted to each person's height.



EASY TO STORE

It can be easily stored wherever you want.



COMPETITIVE PRICE



CAN BE COMBINED

Can be combined with other AMILA products.



GREAT DURABILITY

Does not contain movable parts and features an extremely robust frame



AMILA GluteMaster vs Front Squat

The outcome of the National Strength & Conditioning Association (NSCA) research on a 6-week training program of adolescent athletes using a glute machine (similar to the AMILA GluteMaster) versus front squats was published in the scientific journal The Journal of Strength & Conditioning Research.

Before and after the GluteMaster and Front Squat training, the athletes were measured in the following: vertical and horizontal jump, 10 and 20 meters respectively, isometric mid-thigh pull exercise.

What was observed is a significant improvement in running acceleration, horizontal jump and mid-thigh isometric strength.

	HIP THRUST				FRONT SQUAT			
	PRE	POST	D (abs)	D (%)	PRE	POST	D (abs)	D (%)
Body Mass (Kg)	78.32±12.50	79.85±12.7	+1.49±1.38	+1.87	81.16±12.37	81.71±12.55	+0.55±1.69	+0.67
Vertical Jump (cm)	56.31±8.44	58.23±7.82	+1.92±4.48	+3.30	52.27±8.40	56.09±8.22	+3.82±3.43	+6.81
Horizontal Jump (cm)	2.33±0.20	2.38±0.22	+0.06±0.11	+2.33	2.28±0.24	2.32±0.28	+0.04±0.15	+1.69
10m Sprint	1.76±0.07	1.74±0.08	-0.02±0.03	-1.06	1.79±0.08	1.80±0.11	+0.00±0.09	+0.10
20m Sprint	3.13±0.13	3.07±0.14	-0.05±0.05	-1.70	3.16±0.14	3.14±0.16	-0.02±0.11	-0.67
Hip Thrust	115.85±23.53	165±33.07	+49.54±22.49	+29.95	111.36±20.99	134.85±11.20	+23.45±14.77	+17.40
Front Squat	77.57±12.38	83.08±13.77	+5.50±8.53	+6.63	75.00±10.49	84.64±10.03	+9.64±4.80	+1.52
Isometric Mid-Thigh Pull	2254.31±419.03	2815.31±504.21	+361.00±257.86	+9.22	2683.18±258.35	2734.18±213.09	+51.00±210.83	+1.52
Normalized Isometric Mid-Thigh Pull (N/Kg)	32.84±4.39	35.36±4.12	+2.52±3.30	+7.06	33.41±3.37	34.07±4.98	+0.66±2.35	+1.56

43907

Glute Master

Adductor and Glut Machine

AMILA®

glutemaster



Lear more about GluteMaster on www.glutemaster.gr or scan the QR



SCAN HERE 
to view Glute Master's Video Presentation on our YouTube channel.

SPECIFICATIONS

- Dimensions: 147,0x61,0x40,0 cm
- NET weight: 27 kg
- Frame Tube: 50x50x2 mm
- Flooring Material: Rubber
- Flooring Thickness: 3 mm
- Pad Dimensions: 61x20 cm
- Paint: Electrostatic
- Category: F1



43908

- > Tube: 97x50x2mm
- > Pillow: Cover 1mm PVC, filled with recycled cotton

Commercial Grade

Glute Master (NEW)

+ Comfortable PU pillows

+ Many pins to connect tubes



+ Heavy construction, made of thick 97x50x2,5mm tube, full commercial use

+ Easy to use hight adjustment pins



+ Transport wheels



+ Rubber feet for floor protection

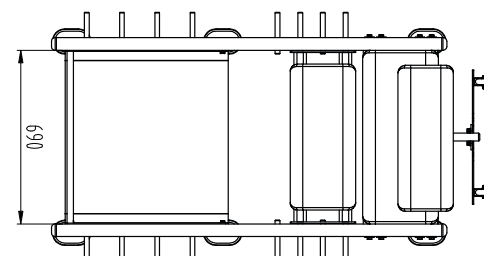
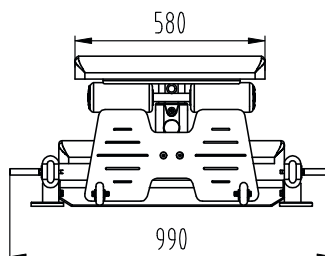
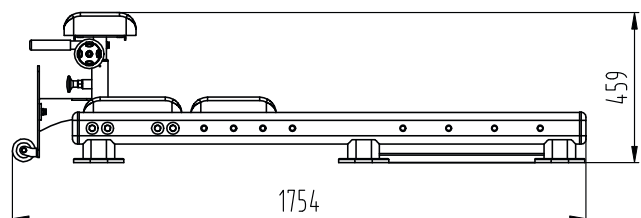

176x99x49cm

Weight 63,5kg Category F1

44761

- > Tube: Square 45x1,5mm & 38x1,5mm

Sissy Squat

46436

Sissy Squat Accessory

To be attached to #46420 cage, p. 44

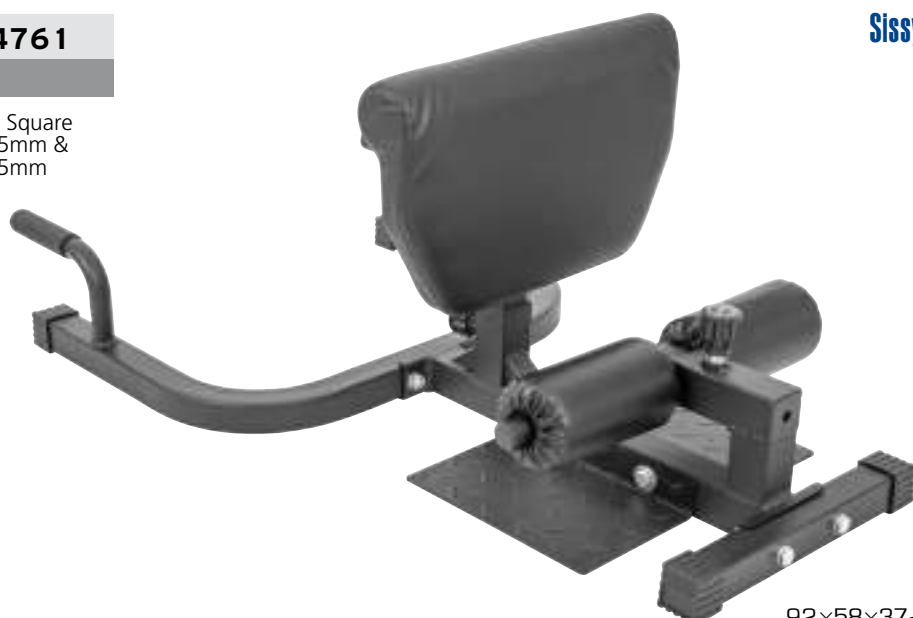

Category F1

92x58x37~43cm

91551

FULL Commercial Grade

Power Lifting Bench

- > **Tube:** 60x60x3 & 75x3mm
- > **Back:** 1220x300x70mm
- > **Seat:** outer material 1,2mm thick, inner material EPE sponge, medium foam sponge & plank

Suitable for Bench Powerlifting events



Weight 140Kg Strength 500Kg Category F2

195x192x110cm

IF2011

Semi-Commercial Grade

inimpulse

Adjustable Weight Bench

IF2011

- > **Tubes:** 50,8x76,2x2,5mm, 50,8x2,5mm and 40,0x80,0x2,5mm
- > **Pillow:** Polymer inside, covered by 1,2mm PVC
- > **Seat height:** 502mm
- > **Pillows:** Back 3665x278mm & 503x287mm, seat 400x406mm, all 75mm thick
- > **Seat angles:** 0°, 10°, 20°
- > **Back angles:** -20°, 0°, 20°, 35°, 50°, 65°, 85°



SCAN HERE 
 Promo Video on our YouTube channel



Weight 30Kg Max Weight 350Kg Category F1

127x57x50cm

44752

Semi-Commercial Grade

Weight Bench

- > **Tube:** 50x75x1.5mm
- > **Back angles:** 0°, 10°, 20°, 30°
- > **Back:** 800x286x50mm
- > **Seat:** 500x340x50mm, outer material 1,2mm thick, inner material EPE sponge, medium foam sponge & plank

+ For personal studios



SCAN HERE to view the Assembly Video on our YouTube channel.



Weight 41 Kg Strength 250Kg Category F1

109x186x145cm

46106

Semi-Commercial Grade

Weight Bench

- > **Tube:** Square 50x70x2mm
- > **Back:** 1200x290x60mm, outer material 1,2mm thick, inner material regenerated sponge, medium foam sponge & plank

+ Suitable for small gyms

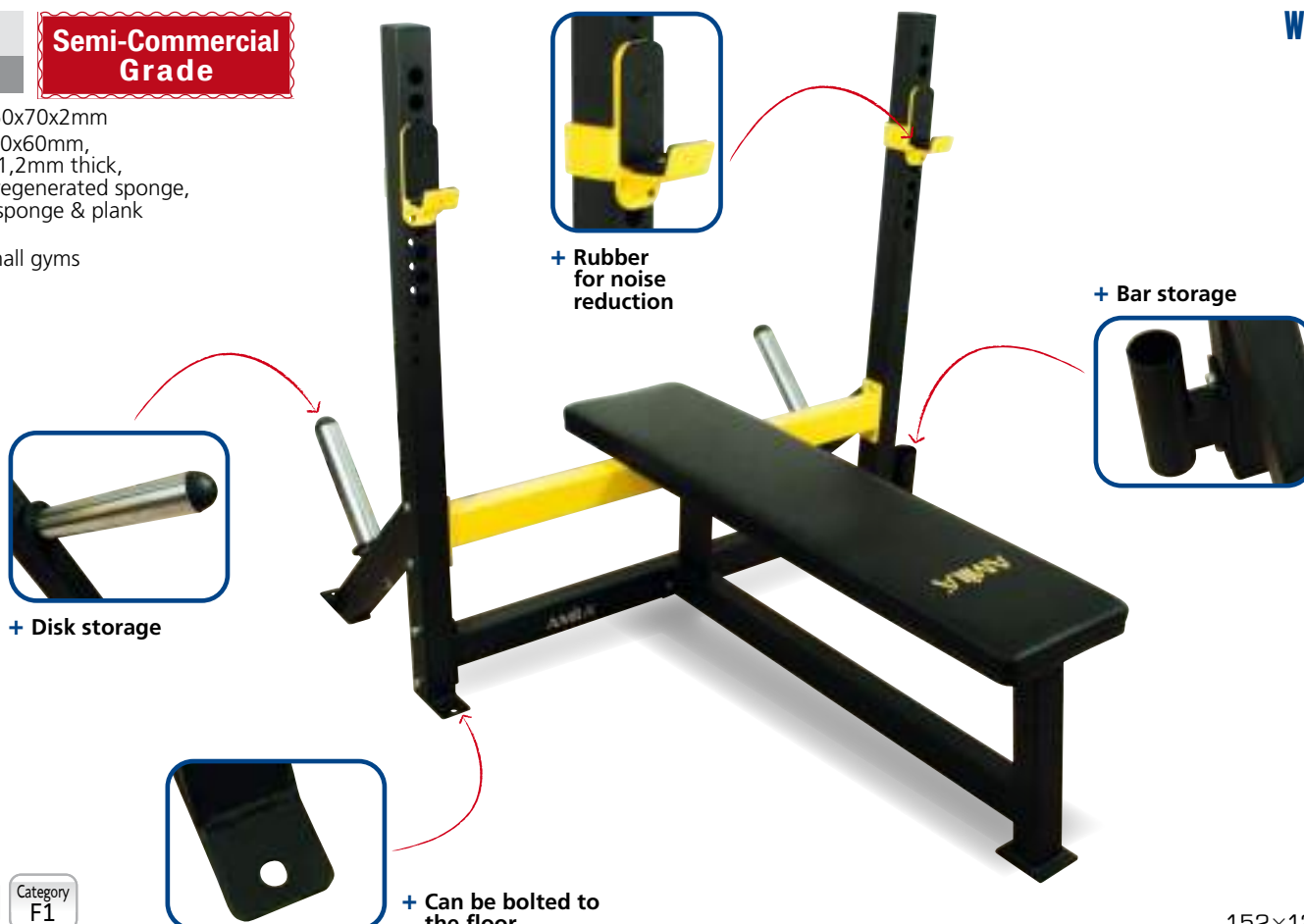

Weight 48 Kg Strength 350Kg Category F1

152x120x121cm

43960

Weight Bench

FULLY ASSEMBLED

- > **Tube:** 50x40x2mm
- > **Back:** 780x265x50mm
- > **Seat:** 340x265x50mm, outer material 1mm thick, inner material medium foam sponge & plank



90° incline in vertical position

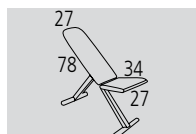

Weight 26 Kg

Strength 350Kg

Category F1

123x33x122cm

44760

Semi-Commercial Grade

Sit Up Bench

With wheels

- > **Tube:** 50x70x1.5mm
- > **Back angles:** -20°, 0°, 20°, 35°, 50°, 60°, 80°
- > **Seat angles:** 0°, 20°, 35°
- > **Back:** 800x286x50mm
- > **Seat:** 286x320x50mm, outer material 1,2mm thick, inner material EPE sponge, medium foam sponge & plank



Weight 20 Kg

Strength 250Kg

Category F1

131x59x45cm

44748

F1-3853

- > **Tube:** 80x40x2mm
- > **Back angles:** 0°, 20°, 30°, 45°, 60°, 80°
- > **Seat angles:** 0°, 20°, 43°
- > **Back:** 790x250x60mm
- > **Seat:** 320x250x70mm, outer material 0,7mm thick, inner material EPE sponge, medium foam sponge & plank

- Adjustable back and seat



+ Very thick cushion offering better support



90° incline in vertical position



Fe Steel

Weight 21 Kg

Strength 300Kg

Category F1

140x60x134cm

44250

FOLDING

Combination Bench

- > **Tube:** 50x1.5mm
- > **Back:** 780x310x70mm
- > **Seat:** 310x300x45mm, outer material 0,7mm thick, inner material EPE sponge, medium foam sponge & plank

+ Anatomical shape for proper back support



GS

Weight 31 Kg

Strength 150Kg

Category D7

177x134x131cm

44753

Combination Bench

- > **Tube:** 50x1.5mm & 38x1.5mm
- > **Back:** 681x292x50mm
- > **Μαξιλάρι δικεφάλων:** 441x307x50mm
- > **Seat:** 330x254x50mm, outer material 0,7mm thick, inner material EPE sponge, medium foam sponge & plank



Weight 29 Kg Strength 250Kg Category D7

140x80x118cm

43968

Sit-up Bench

- > **Tube size:** 50x50x1.5mm
- > **Back:** 880x260/220x45mm
- > **Seat:** 370x360-270x45mm



Weight 26 Kg Strength 250Kg Category F1

173x65x43cm

44756

Weight & Sit Up Bench

- > **Tube:** 50x1,5mm
- > **Back:** 780x310x45mm
- > **Pad:** 460x250x45mm
- > **Seat:** 310x300x45mm, outer material 0,7mm thick, inner material EPE sponge, medium foam sponge & plank



- Easy to adjust back incline



- Adjustable seat incline



- Lockable front, enabling abs exercises

Weight 22,5 Kg Strength 250Kg Category D7

185x59x92cm

43969

Sit-up Bench

- > **Tube size:** 50x50x1.5mm



Strength 250Kg Category F1

91401

Dumbbell Bench AWB508G

- **Adjustable incline**
- Easy to fold and store in a small space
- For push-ups, knee raises, sit-ups, dumbbell exercises, back extensions

- > **Tube:** 50x50x1.5mm
- > **Pad:** EVA double floor upholster
- > **Seat wood:** 12mm thick
- > **Seat pad:** 50mm thick
- > **Back pad:** 50mm thick



SCAN HERE  to view the Assembly Video on our YouTube channel.



Weight 18Kg Strength 150Kg Category D7

153.5x65.5x93,5cm

43940

Sit Up Bench

- > **Main tube:** 60x30x1.5mm
- > **Back:** 780x270x45mm
- > **Seat:** 330x270x45mm, outer material 0,7mm thick, medium foam sponge & plank



- Leg support for abs exercises



- Adjustable seat incline



- Adjustable back incline



Weight 16 Kg Strength 200Kg Category D7

125x50x125cm

91403

Weight Bench DT30

- > **Tube:** 50x50x1.5mm
- > **Seat wood:** 12mm thick
- > **Seat pad:** 50mm thick
- > **Back pad:** 50mm thick



SCAN HERE  to view the Assembly Video on our YouTube channel.



Weight 14Kg Strength 200Kg Category D7

146x67,5x121cm

91406

Utility Bench AWB550

- > **Seat pad:** 64mm thick
- > **Back pad:** 64mm thick



SCAN HERE  to view the Assembly Video on our YouTube channel.

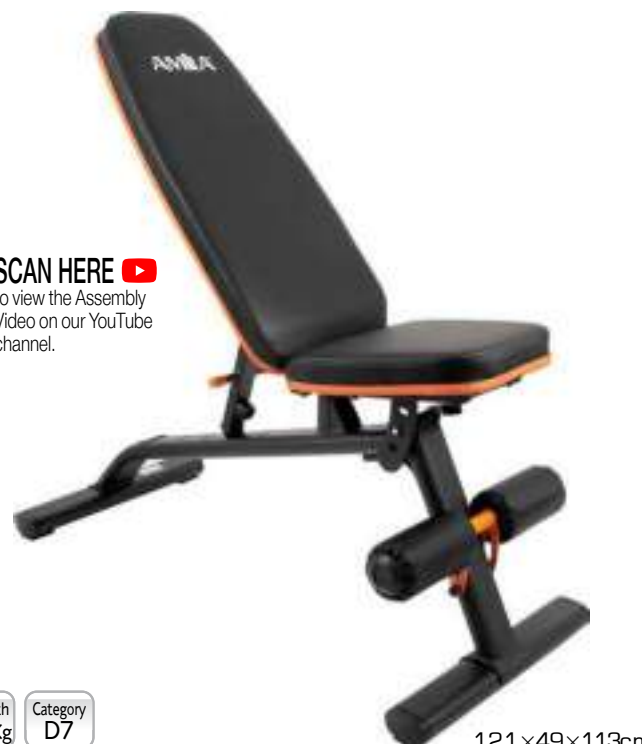

Weight 16Kg Strength 200Kg Category D7

121x49x113cm

43966

Multi Bench

- > **Main tube:** 60x30x1.5mm
- > **Back:** 700x260x50mm
- > **Back angles:** -25°, 0°, 20°, 40°, 55°, 85°
- > **Seat:** 340x260x50mm, outer material 0,7mm thick, inner material regenerated sponge, medium foam sponge & plank



Weight 14 Kg Strength 250Kg Category F1

115x53x48cm

44244

Sit Up Bench

- > **Main tube:** 70x30x1.8mm
- > **Back:** 750x300x45mm
- > **Back angles:** -10°, 0°, 15°, 35°, 55°, 90°
- > **Seat:** 350x300x45mm, outer material 0,7mm thick, medium foam sponge & plank



90° incline in **vertical** position

Weight 10,5 Kg Strength 200Kg Category D7

125x45x98cm

91451

Flat Bench BRT100

- For dumbbell exercises, push-ups, sit-ups, back extensions
- > **Tube:** Heavy duty 50*50*1.5mm steel construction with durable powder coating finishing
- > **Pad:** EVA double floor upholster
- > **Max user weight:** 120kgs



Weight 10Kg Strength 150Kg Category D7

40x44x134,5cm

43906

Back Extension

- > **Main tube:** 50x70x2mm



+ reinforced construction for greater stability

+ with footrest

Weight 17Kg Strength 120Kg Category D7

129x66x68cm

43910

Multi Function Flat Bench

- > **Main tube:** 50x1.5mm
- > **Back:** 1110x250x55mm, outer material 0,7mm thick, inner material EPE sponge, medium foam sponge & plank



Weight 10 Kg
Strength 200Kg
Category D7

43x111x41cm

44751

Sit Up Bench

Commercial specs, thick pillow

- > **Main tube:** 38x1.2mm
- > **Back:** 1100x300x60mm, outer material 0,75mm thick, inner material medium foam sponge & plank



Weight 10,5 Kg
Strength 200Kg
Category D7

140x36x60cm

44750

Sit Up Bench

- > **Main tube:** 38x1.2mm
- > **Back:** 980x300x45mm, outer material 0,7mm thick, inner material EPE sponge, medium foam sponge & plank



Weight 8,5 Kg
Strength 120Kg
Category D7

123x34x62cm

44257

Sit Up Bench

- > **Main tube:** 38x1.2mm
- > **Back:** 980x300x60mm, outer material 0,7mm thick, inner material EPE sponge, medium foam sponge & plank



Weight 7 Kg
Strength 200Kg
Category D7

130x33x50cm

91501

Bar Post BR500



> Both Ø28 and Ø50 disks can be stored

Fe Steel Weight 26 Kg Category F1

44744

Bar posts

combined with 44748

> Max endurance: 200kg



Fe Steel Weight 28,5 Kg Category F1

84~119x93x90~160cm

44745

Bar posts

> 9 height positions, 5 width position



Weight 19 Kg Category F1

80~112x70x97~150cm

43955

Bar Posts



Fe Steel Weight 18 Kg Category D7

48x43x170cm

44348

Bar Posts

> Able to support more than 250Kg (the pair)
> Height: 0,80~1,20 m.



Fe Steel Weight 9,40 Kg Category D7

Ακρίβεια στο Βάρος

Το βάρος ενός μαντεμένου δίσκου μπορεί να κυμαίνεται να $\pm 5\%$ του βάρους του. Εάν είναι πολύ παραπάνω, η ποιότητα δεν είναι καλή.

Φινίρισμα

Το φινίρισμα αποτελείται από 4 στάδια:

1. Σωστή λείανση του δίσκου μόλις βγει από το καλούπι.
2. Βάψιμο με ειδικά αντισκωρικά χρώματα, που μετά το φούρνισμα δημιουργούν, ένα προστατευτικό στρώμα γύρω από τον δίσκο.
3. Το σωστό φούρνισμα του δίσκου, ώστε να δημιουργηθεί ένα προστατευτικό φιλμ, που θα του δίνει ωραία εμφάνιση (εμαγιέ) ενώ ταυτόχρονα το προστατεύει από την οξείδωση (σκουρίασμα).
4. Τέλος περνιέται ένα ειδικό λαδί/βερνίκι που του δίνει λάμψη και προστασία.



Βαφή

Ειδική κατεργασία μετάλλων σε υψηλές θερμοκρασίες και χρήση ποιοτικών χημικών.

Περιεκτικότητα

Περιεκτικότητα Σιδήρου στο Μαντέμι: Όσο πιο λεπτός είναι ο δίσκος, τόσο μεγαλύτερη είναι η περιεκτικότητά του σε σίδηρο. Οι δίσκοι με υψηλή περιεκτικότητα σιδήρου έχουν μεγάλη διάρκεια ζωής και αντέχουν στις καταπονήσεις.

Αναλογία Πρωτογενούς και Ανακυκλώσιμου ελαστικού

Όλα τα λάστιχα έχουν κάποιο ποσοστό ανακυκλώσιμου υλικού. Εάν η αναλογία αυτή ξεπερνά το ανώτερο επιτρεπτό όριο, ενδέχεται το βάρος να αναδύει δυσάρεστες οσμές.



Οι **λαβές** βοηθούν στην ευκολότερη μετακίνηση των δίσκων.

Πάχος του λάστιχου

Εάν η επικάλυψη είναι πολύ λεπτή τότε το πλεονέκτημα του λαστιχένιου βάρους είναι ανύπαρκτο.

Δαχτυλίδι

Διευκολύνει την εναλλαγή των δίσκων.

Περιεκτικότητα

Όσο πιο λεπτός είναι ο δίσκος, τόσο μεγαλύτερη είναι η περιεκτικότητά του σε σίδηρο. **Οι δίσκοι με υψηλή περιεκτικότητα σιδήρου είναι πολύ πιο ποιοτικοί.**

- * Τα αλτηράκια βινυλίου μπορούν να καλυφθούν με neoprene. Αυτό προσφέρει μαλακή αίσθηση και μεγαλύτερη προστασία σε περίπτωση πτώσης.

Βάρη

Ένα ποιοτικό Βάρος Εμαγιέ εξαρτάται από:

το Φινίρισμα τη Βαφή και την Περιεκτικότητα

Ένα ποιοτικό Λαστιχένιο Βάρος εξαρτάται από:

Πάχος του λάστιχου, δαχτυλίδι, περιεκτικότητα

- * Ο χρήστης μπορεί να δοκιμάσει πρόχειρα την ποιότητα και το πάχος του ελαστικού από την αναπήδηση που παράγεται με την πτώση ενός βάρους 2.5Kg σε μια επιφάνεια.

- * Τα πλαστικά αλτηράκια είναι γεμισμένα με ένα μείγμα τσιμέντου και ριניσιμάτων σιδήρου. Το μείγμα αυτό ενδέχεται να μην έχει ισοκατανεμηθεί μέσα στο πλαστικό και έτσι το αλτηράκι μπορεί να έχει κενά και να μην είναι απόλυτα ζυγισμένο

Αλτηράκια Πλαστικά

- Βάρος (δεν υπάρχει ισοκατανομή βάρους)
- Ογκώδη
- Τιμή

Αλτηράκια Βινυλίου

- Βάρος (είναι ζυγισμένα)
- Λειτουργικά (στο σωστό μέγεθος)
- Γυαλιστερή Εμφάνιση
- Τιμή
- Επικινδυνότητα (αν πέσουν ίσως προκαλέσουν ζημιά στο δάπεδο)
- Ευαισθησία (αν δεν είναι ποιοτικά ενδεχομένως να σπάσουν εύκολα)

Δίσκοι Λαστιχένιοι

- Προστασία (δεν προκαλούν ζημιές στο δάπεδο σε περίπτωση πτώσης)
- Αντοχή (αντέχουν σε μεγαλύτερες καταπονήσεις από τα απλά και επιπλέον δεν σκουριάζουν ποτέ)
- Λειτουργικότητα
- Αισθητική (οι λαστιχένιοι δίσκοι πολυτελείας έχουν πολύ πιο ωραία εμφάνιση και μπορούν να μπουν παντού, ακόμη και στο σαλόνι)
- Τιμή

- > **Material:** Cast iron
- > **Cover:** Natural odorless rubber, 70% primary and 30% recycled
- > **Ring:** ABS very robust and nice looking
- > **Suitable** for $\varnothing 28$ mm bars

- Slightly grained surface
- Innovative treatment of a special rubber giving a great look



- + Absolutely no smell
- + Great texture
- + Easy to use, since the discs slip easily on the bar due to the ring
- + Thick rubber and flat construction for acceptable floor protection

Rubber Covered Plate

CODE	WEIGHT
44470	0,50 Kg
44471	1,00 Kg
44472	2,50 Kg
44473	5,00 Kg
44474	10,00 Kg
44475	20,00 Kg

Category E1

- > **Material:** Cast iron
- > **Cover:** Enameled
- > **Ring:** —
- > **Suitable** for $\varnothing 28$ mm bars

- + The enamelled coating ensures high rust resistance
- + Excellent visual result



Enameled Plate

CODE	WEIGHT
44476	0,50 Kg
44469	1,00 Kg
44477	1,25 Kg
44478	2,50 Kg
44479	5,00 Kg
44480	10,00 Kg
44482	20,00 Kg

Category E1

- > **Material:** Cast iron
- > **Cover:** Natural odorless rubber
- > **Ring:** Plastic
- > **Suitable** for $\varnothing 28$ mm bars

- + Absolutely no smell
- + Acceptable texture
- + Easy to use, since the discs slip easily on the bar due to the ring
- + Thick rubber for acceptable floor protection



Rubber Covered Plate

CODE	WEIGHT
44431	0,50 Kg
44432	1,00 Kg
44433	2,50 Kg
44434	5,00 Kg
44435	10,00 Kg
44437	20,00 Kg

Category E1

- > **Material:** Cast iron
- > **Cover:** Natural odorless rubber
- > **Ring:** —
- > **Suitable** for $\varnothing 28$ mm bars



Rubber Covered Plate

CODE	WEIGHT
90251	1,25 Kg

Category E1

- > **Material:** High-quality cast iron
- > **Cover:** High-quality PU
- > **Ring:** Stainless steel
- > For Ø50mm bars

- + Supreme durability, can't be scratched/destroyed
- + No smell whatsoever
- + Sufficient protection for the floor
- + Excellent feel



PU Covered Disc



CODE	WEIGHT
84641	1,25 Kg
84642	2,50 Kg
84643	5,00 Kg
84644	10,00 Kg
84645	20,00 Kg

Category F1

- > **Material:** Cast iron
- > **Cover:** Natural odorless rubber, 70% primary and 30% recycled
- > **Ring:** Steel
- > **Suitable** for Ø50mm bars

- + Absolutely no smell
- + Natural rubber feel
- + Very robust when compared with standard-quality discs
- + Competitive price



Rubber Covered Disc



CODE	WEIGHT
84565	1,25 Kg
84566	2,50 Kg
84567	5,00 Kg
84568	10,00 Kg
84564	15,00 Kg
84569	20,00 Kg

Category E1

- > **Material:** Cast iron
- > **Cover:** Rubber, 100% primary
- > **Ring:** Stainless steel
- > **Suitable** for Ø50mm bars



Rubber Covered Disc



CODE	WEIGHT
90315	2,50 Kg
90316	5,00 Kg
90318	15,00 Kg
90319	20,00 Kg

Category E1

- > **Material:** Cast iron
- > **Cover:** TPU
- > **Ring:** Stainless steel
- > **Suitable** for Ø50mm bars



TPU Covered Disc



CODE	WEIGHT
90320	2,50 Kg
90321	5,00 Kg
90323	15,00 Kg

Category E1

Bumper Plates

Με τόσους πολλούς αθλητές να εκδηλώνουν έντονο ενδιαφέρον για την **άρση βαρών** (χάρη στο **CrossFit**) η επιλογή των Bumper Plates, είναι μονόδρομος, ακόμα και αν η προπόνηση είναι το μόνο που θα σας ενδιέφερε.



Θα βρείτε 3 βασικές κατηγορίες ποιότητας στα **Bumper Plates** της **AMILA** με μικρές διαφορές που αφορούν κυρίως την ακρίβεια του βάρους, το οποίο επηρεάζει άμεσα το κόστος παραγωγής τους.

Ποιότητες

• Δίσκοι Προπόνησης

Είναι φτιαγμένοι από 100% πρωτογενές λάστιχο κανονικής καθαρότητας.

Η επιτρεπόμενη διακύμανση του βάρους είναι **+/-1%** (δηλαδή σε βάρος 20Kg η διακύμανση που μπορεί να γίνει αποδεκτή φτάνει μέχρι τα 200gr).

Είναι ιδανικοί για CrossFit όπου η πολύ μεγάλη ακρίβεια στο βάρος δεν είναι το ζητούμενο.

• Χρωματιστοί Δίσκοι

Είναι φτιαγμένοι από 100% πρωτογενές λάστιχο υψηλής καθαρότητας (άριστης ποιότητας).

Η επιτρεπόμενη διακύμανση του βάρους είναι **+/-1%** (δηλαδή σε βάρος 20Kg η διακύμανση που μπορεί να γίνει αποδεκτή φτάνει μέχρι τα 200gr).

Η ποιότητα του ελαστικού αυξάνει την αντοχή κατά 8-10%.

• Αγωνιστικοί Δίσκοι

Είναι φτιαγμένοι από 100% πρωτογενές λάστιχο υψηλής καθαρότητας (άριστης ποιότητας).

Η επιτρεπόμενη διακύμανση του βάρους είναι **+/-5gr**.

Αυτή η ακρίβεια τους καθιστά **κατάλληλους ακόμα και για αγώνες**.

Εξαιτίας του κενού που έχουν μεταξύ του λάστιχου και του ανοξείδωτου μετάλλου των βαρών, διαθέτουν **επιπλέον της ήδη αυξημένης αντοχής** (λόγω της ποιότητας του ελαστικού).

Τι είναι τα Bumper Plates;

Bumper Plates, Δίσκοι Ρίψεων, Δίσκοι Αναπήδησης ή απλά Ολυμπιακοί Δίσκοι είναι οι Ολυμπιακές Πλάκες που **είναι υπενδεδυμένες με τεχνικό τρόπο από χοντρό και σκληρό ειδικό ελαστικό έτσι ώστε μια μπάρα με υψηλό φορτίο να μπορεί να "πέσει" με ασφάλεια**, χωρίς κίνδυνο καταστροφής οποιουδήποτε υλικού ή του πατώματος.

Σκεφτείτε τι θα γινόταν εάν ένας 20κιλος δίσκος έπεφτε στο πάτωμα κατά λάθος, στην προσπάθειά σας να τον μεταφέρετε από και προς την μπάρα και πόσο πιο μεγάλη θα ήταν η ζημιά εάν έπεφτε από υπερυψωμένη θέση κατά τη διάρκεια της άσκησης.

Τα Bumper Plates λοιπόν επιτρέπουν να γίνονται με ασφάλεια όλες οι ασκήσεις που έχουν ρίψεις αλλά και άλλες.

Εμαγιέ Δίσκοι (με επικάλυψη πολουρεθάνης) vs Bumper Plates

Η πιο διαδεδομένη επιλογή για τις ασκήσεις με βάρη είναι οι δίσκοι εμαγιέ που επικαλύπτονται από ένα λεπτό στρώμα πολουρεθάνης (λάστιχου). Πρόκειται για μια επιλογή των γυμναστηρίων (έναντι των απλών εμαγιέ δίσκων που χρησιμοποιούνταν παλαιότερα) επειδή εξασφαλίζουν μεγαλύτερη αντοχή, ευκολία κατά τη χρήση, μικρότερους θορύβους και αγωνιστική εμφάνιση.

Το κόστος αυτών των εμαγιέ δίσκων με επικάλυψη προσεγγίζει περισσότερο τις τιμές αγοράς των bumper plates παρά τις τιμές των εμαγιέ. Όμως, σίγουρα δεν είναι bumper plates. Δεν πρόκειται να πέσουν από ψηλά με ασφάλεια και έτσι καθίστανται άχρηστοι για το CrossFit και την Άρση Βαρών. Εξαιτίας των ανωτέρω και του γεγονότος ότι δεν έχουν ουσιαστική διαφορά κόστους, **δεν υπάρχει κανένας λόγος να σας συστήσουμε αυτό το είδος για τις συγκεκριμένες ασκήσεις**.

Τα Bumper Plates της **AMILA** περνούν το test των 20.000 ρίψεων από ύψος 2 μέτρων.

Σκληρότητα Ελαστικού

Η **Shore Durometer** είναι μια από τις μετρήσεις που μπορούμε να κάνουμε στο ελαστικό. Μια υψηλή μέτρηση υποδηλώνει υψηλή ποιότητα υλικού.

Μεγάλες εταιρίες στον ανταγωνισμό κυμαίνονται μεταξύ 78 και 88 μονάδων μέτρησης. Τα ελαστικά που χρησιμοποιούμε στα προϊόντα **AMILA** ξεπερνούν ακόμα και τις μέγιστες τιμές του ανταγωνισμού καταδεικνύοντας τα **υψηλά standards των επιλογών μας**.



Δαχτυλίδι

Το δαχτυλίδι των δίσκων είναι πάρα πολύ ισχυρό. Έχει ενσωματωθεί με τέτοιο τρόπο έτσι ώστε να μπορεί να αντέχει σε υψηλές πιέσεις που ξεπερνούν τα 2.300Kg.

10 KG	15 KG	20 KG
132± mm	142± mm	152± mm

Χρώματα & Διαστάσεις των Competition Δίσκων

Τα αγωνιστικά Bumper Plates είναι **χρωματισμένα με συγκεκριμένο χρώμα ανά βάρος** ενώ τα Bumper Plates γενικής χρήσης είναι συνήθως μονόχρωμα.

Όλοι οι δίσκοι έχουν την **ίδια διάμετρο (Ø45cm)** σε όλα τα κιλά. **Το μόνο που διαφοροποιείται στις διαστάσεις είναι το πάχος**.



> Material: Rubber
> For 50mm bars

Professional Crossfit Disks

All the disks have the same 45cm diameter



> Items 84600 & 94601 are priced per item, but sold per pair

CODE		COLOR	WEIGHT
84600		Black	5,00 Kg
84601		Black	10,00 Kg
84602		Black	20,00 Kg

Category E1



> Material: Rubber
> For 50mm bars

Professional 1st Quality Crossfit Disks

All the disks have the same 45cm diameter



CODE		COLOR	WEIGHT
84603		Grey	5,00 Kg
84604		Green	10,00 Kg
84605		Blue	20,00 Kg

Category E1



Commercial Crossfit Disks

All the disks have the same 45cm diameter



> Items 90306 & 90307 are priced per item, but sold per pair

CODE		COLOR	WEIGHT
90306		Black	5,00 Kg
90307		Black	10,00 Kg
90309		Black	15,00 Kg
90308		Black	20,00 Kg

Category E1

A-Plates

Ειδικό μείγμα λάστικου, πιο μαλακό από τα υπόλοιπα Bumper Plates με διαφορετική πυκνότητα στο εξωτερικό δακτύλιο απ' ότι στο εσωτερικό του δίσκου για μεγαλύτερη ανθεκτικότητα

ΛΑΣΤΙΧΟ ΜΕ 2 ΣΤΡΩΣΕΙΣ. Η επιφανειακή στρώση είναι πιο μαλακή, προσφέροντας μεγαλύτερη προστασία στο πάτωμα ενώ η εσωτερική πιο σκληρή για αυξημένη αντοχή

25%
ΜΕΙΩΣΗ
ΑΝΑΠΗΔΗΣΗΣ

30%
ΜΕΙΩΣΗ ΘΟΡΥΒΟΥ
ΣΤΙΣ ΠΤΩΣΕΙΣ

35%
ΜΕΙΩΣΗ
ΚΡΑΔΑΣΜΩΝ

ΟΛΥΜΠΙΑΚΟΥ
ΤΥΠΟΥ



ΠΡΟΣΙΤΗ
ΤΙΜΗ



ΧΑΜΗΛΗ
ΑΝΑΠΗΔΗΣΗ



ΑΟΣΜΟ
ΥΛΙΚΟ



ΑΨΟΓΟ
ΦΙΝΙΡΙΣΜΑ



CROSSFIT

PLATES APPROVED BY AMILA

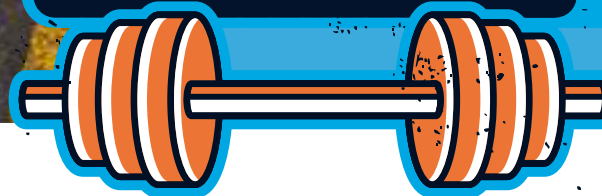

A-Plates

CODE	COLOR	WEIGHT	DIAMETER
84803	Grey	5,00 Kg	40cm
84804	Green	10,00 Kg	45cm
84805	Yellow	15,00 Kg	45cm
84806	Blue	20,00 Kg	45cm
84807	Red	25,00 Kg	45cm

**OLYMPIC
SIZE**

!!! Items # 84803 & #84804 are priced per item but sold per pair



Category
E1



44372

- > **Discs:** 4 x 1.00kg, 2 x 2.00kg
- > **Grip:** 1 pc 2kg, 350x28mm with 2 star collars



Weight 10Kg Category E1

Dumbbell Set
1 x 10kg
Chromed

44396

- > **Discs:** 4 x 1.25kg, 4 x 2.50kg
- > **Grips:** 2 pcs 2,3kg each, 350x30mm with 2 star collars



Weight 20Kg Category E1

Dumbbell Set
2 x 10kg
Hammered

44375

- > **Collar:** Straight
- > **Dimensions:** Ø28mmx35,5cm



Weight 2Kg Category E1

Dumbbell

44155

Bar Sponge



Weight 219gr Category E1

Ø10x45cm

90861

Barbell Pad



Category F1

31,5x13,5x5,5cm

44376

- > **Collar:** Screwed
- > **Dimensions:** Ø28mmx35cm



Weight 2Kg Category E1

Dumbbell

44154

Bar Pillow

For squats



Std Pack 15 Category D10

450x78x28mm

83286

Barbell Pad

- > **Material:** High-density gel
- > **Closure:** Velcro, easy to use



Category F1

Ø7,5x41cm

44379

Dumbbell
Rubber covered grip

- > **Collar:** Screwed
- > **Dimensions:** Ø28mmx35cm



Weight 2Kg Category E1

44430

**OLYMPIC
SIZE**

Olympic Colars

- > Material: Aluminum
- > Diameter: Ø50mm
- > Packing: Polybag

PCS
2Category
E1

44428

**OLYMPIC
SIZE**

Olympic Colars

- > Material: Plastic
- > Diameter: Ø50mm
- > Packing: Polybag
- Nylon resin frame and injection molded pressure pads
- Single-action cam lock
- Permanent spring snap-latch, easily released with one hand



44400

- > Diameter: Ø28mm

PCS
2Category
E1

44395

Colars
"Spring"

- > Diameter: Ø28mm



- > Priced per item
- > Sold per pair

PCS
1Category
E1

44392

Colars
"Ring"

- > Diameter: Ø28mm



- > Priced per item
- > Sold per pair

PCS
1Weight
51grCategory
E1

44390

Colars
"Star"

- > Diameter: Ø28mm



- > Priced per item
- > Sold per pair

PCS
1Weight
190grCategory
E1

83290

Tera Grip

- > Material: Silicone
- > Inner diameter: Ø25mm

PCS
2Weight
480grCategory
E3

Ø5,5×12,5cm

44398

**OLYMPIC
SIZE**

Olympic Colars

"Spring"

> Diameter: Ø50mm



> Priced per item
> Sold per pair

PCS 1 Category E1

90852

**OLYMPIC
SIZE**

Olympic Colars

> Material: Rubber covered **Steel**
> Diameter: Ø50mm



PCS 2 Category E1

18,5×9,5×5,5cm

44438

**OLYMPIC
SIZE**

Olympic Colars

> Material: **Aluminum**
> Diameter: Ø50mm
> **Heavy duty**, each weighting 250gr
> Hermetically locked
> With inner rubber coating to prevent slipping
> Handle made of plastic more durable than ABS
> With magnets for ease of use



PCS 2 Category E1

44397

**OLYMPIC
SIZE**

Colar

> Diameter: Ø50mm



PCS 2 Weight 2,5Kg Std Pack 50 Category E1

διάσταση: 2.18m #80041

Μπάρα Αρσης Βαρών Ολυμπιακού Τυπού "Heavy Duty" 200.000PSI

Αντοχή (Tensile Strength)

Ο αναγραφόμενος αριθμός PSI (Pound per Square Inch) είναι το σημείο θραύσης της μπάρας. Τα 150.000PSI είναι μια καλή τιμή για ασφαλείς μπάρες.

Ωστόσο, τα 200.000PSI της μπάρας AMILA εγγυώνται άρσεις χωρίς προβλήματα!

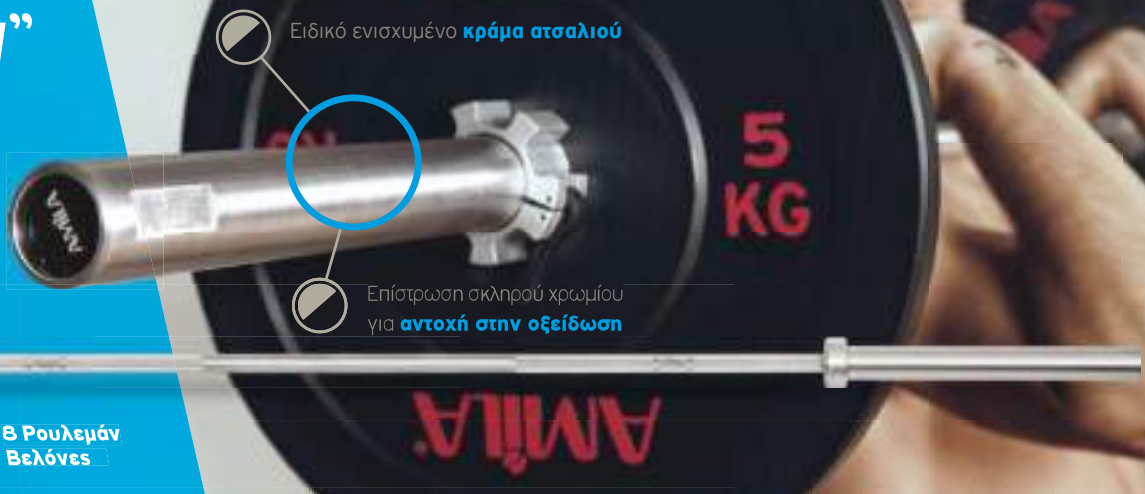

Τα δύο άκρα (sleeves) μιας μπάρας έχουν μεγαλύτερη διάμετρο από τον κεντρικό άξονα και είναι τα σημεία στα οποία βάζουμε τα βάρη.

Τα άκρα περιστρέφονται ανεξάρτητα από τον κεντρικό άξονα-λαβή με τη βοήθεια εδράνων. Ο λόγος για την ανεξάρτητη κίνηση των άκρων είναι απλός. **Η κίνηση των καρπών κατά τη διάρκεια μιας άρσης δημιουργεί περιστροφική κίνηση του άξονα της μπάρας.**

Άκρα (Sleeves)

Η περιστροφή των άκρων πρέπει να είναι **ομαλή**. Αυτό δεν πρέπει να συμβαίνει μόνο όταν η μπάρα είναι καινούρια αλλά καθ' όλη τη διάρκεια ζωής / χρήσης.

Tip *



Οι **PowerBars** έχουν σχεδιαστεί για βαριά **deadlift, squats** και **πιέσεις πάγκου**.

Οι **Ολυμπιακές Μπάρες** έχουν σχεδιαστεί για τις δυο εκρηκτικές κινήσεις της άρσης βαρών, του **αρασέ** και το **επολέ ζετέ (snatch και clean & jerk)**.

Bushing

Bushing είναι τα δαχτυλίδια που κατασκευάζονται με **υλικό χαμηλής τριβής** (συνήθως **μπρούτζο**) τα οποία τοποθετούνται ανάμεσα στον άξονα-λαβή και στο εξωτερικό περιβλήμα του άκρου.

Η τεχνολογία αυτή χρησιμοποιείται σχεδόν σε όλες τις υβριδικές (διπλής χρήσης) μπάρες και στις μπάρες για powerlifting.



Needle Bearings

Η τεχνολογία αυτή συνήθως χρησιμοποιείται σε μπάρες υψηλών επιδόσεων που χρησιμοποιούνται στην **Ολυμπιακή Άρση Βαρών**.

- + Εύκολη περιστροφή
- + Ομαλή κίνηση
- + Αθόρυβη λειτουργία
- Υψηλό κόστος
- Ευαίσθητη τεχνολογία

Βασικά στοιχεία σε μια μπάρα

- Ποιότητα του χάλυβα που χρησιμοποιείται για την κατασκευή της μπάρας
- Διάμετρος της ράβδου
- Ποιότητα και ομαλότητα ρίκνωσης (του κόνδυλου) στην περιοχή λαβής
- Ποιότητα και αριθμός ρουλεμάν που χρησιμοποιούνται στα άκρα (sleeves) στήριξης των βαρών
- Ποιότητα συνδεσμολογίας
- Τήρηση προτύπων σχετικά με το βάρος και το μήκος

Αντοχή (Tensile Strength)

Η αντοχή μιας μπάρας μετράται σε **PSI** (Pounds/Square Inch, Λίβρες/Τετραγωνική Ίντσα). Ο **"ονομαστικός"** αριθμός PSI κάθε μπάρας είναι το σημείο θραύσης της μπάρας σύμφωνα με τον κατασκευαστή. Αποφύγετε μπάρες που δεν αναφέρουν τη συγκεκριμένη τιμή στα τεχνικά τους χαρακτηριστικά, αφού κάτι τέτοιο συνήθως σημαίνει ότι η αντοχή τους είναι αρκετά χαμηλή. Γενικά ονομαστική τιμή της τάξης των 150.000PSI είναι ένα καλό ελάχιστο όριο, ενώ με 180.000PSI είναι μια τιμή που εγγυάται άρσεις χωρίς προβλήματα. Γενικά όσο αυξάνεται η αντοχή, τόσο αυξάνεται και η τιμή μιας μπάρας.

Ο **μέσος όρος** των Ολυμπιακών Μπαρών που κατασκευάζονται "πωλούνται" με πιστοποίηση **800 ή 1.000 λιβρών** των 120.000-150.000PSI.

Tip *

Στην ουσία **δεν υπάρχει κανενός είδους δοκιμή PSI**.

Αυτό είναι μια φανταστική υπόθεση που δημιουργήθηκε σε μια προσπάθεια να ικανοποιήσει τους αγοραστές με περιορισμένη γνώση και να τους κατευθύνει στην επιλογή τους.

Λαβή Άρση Βαρών

Λαβή Ασκήσεων Πάγκου

Bars

With straight collar

<p>44350</p> <ul style="list-style-type: none"> > Ø28mm x 120cm > b = 18cm > Grip: Ø27,5mm > Max lift: 500lb/227kg <p>Weight 6Kg</p>	<p>44351</p> <ul style="list-style-type: none"> > Ø28mm x 140cm > b = 28cm > Grip: Ø28mm > Max lift: 500lb/227kg <p>Weight 7Kg</p>	<p>44352</p> <ul style="list-style-type: none"> > Ø28mm x 160cm > b = 31cm > Grip: Ø25mm > Max lift: 500lb/227kg <p>Weight 8Kg</p>	<p>44353</p> <ul style="list-style-type: none"> > Ø28mm x 180cm > b = 32.5cm > Grip: Ø28mm > Max lift: 500lb/227kg <p>Weight 9Kg</p>	<p>44354</p> <ul style="list-style-type: none"> > Ø28mm x 200cm > b = 38cm > Grip: Ø28mm > Max lift: 500lb/227kg <p>Weight 10Kg</p>	<p>Category E1</p>
--	--	--	--	---	--------------------

Bars

With screwed collar

<p>44362</p> <ul style="list-style-type: none"> > Ø28mm x 120cm > d ≈ 87,5cm > Max lift: 310lb/140kg <p>Weight 6Kg</p>	<p>44363</p> <ul style="list-style-type: none"> > Ø28mm x 140cm > d ≈ 96cm > Max lift: 310lb/140kg <p>Weight 7Kg</p>	<p>44364</p> <ul style="list-style-type: none"> > Ø28mm x 160cm > d ≈ 108cm > Max lift: 310lb/140kg <p>Weight 8Kg</p>	<p>44365</p> <ul style="list-style-type: none"> > Ø28mm x 180cm > d ≈ 114,5cm > Max lift: 310lb/140kg <p>Weight 9Kg</p>	<p>44366</p> <ul style="list-style-type: none"> > Ø28mm x 200cm > d ≈ 127cm > Max lift: 310lb/140kg <p>Weight 10Kg</p>	<p>Category E1</p>
---	---	--	--	---	--------------------

<p>44356</p> <ul style="list-style-type: none"> > Ø28mm x 120cm > b = 17.5cm > Grip: Ø26mm > Max lift: 500lb/227kg <p>Weight 6Kg</p>	<p>44355</p> <ul style="list-style-type: none"> > Ø28mm x 140cm > b = 23cm > Grip: Ø27mm > Max lift: 500lb/227kg <p>Weight 7Kg</p>	<p>Bars</p> <p>“W” shaped, straight collar. With straight collar.</p> <p>Category E1</p>
--	--	---

<p>44360</p> <ul style="list-style-type: none"> > Ø28mm x 120cm > Max lift: 310lb/140kg <p>Weight 6Kg</p>	<p>44358</p> <ul style="list-style-type: none"> > Ø28mm x 140cm > Max lift: 310lb/140kg <p>Weight 7Kg</p>	<p>Bars</p> <p>“W” shaped, straight collar. With screwed collar.</p> <p>Category E1</p>
---	---	--

- Material:** Neoprene for support and warmth with good compression (5mm in front and 3mm on the back)
- > **Multi-purpose** sport
 - > **Protecting** your knees
 - > **Provide** support to your knee joint and reduces injury of your knee caused by friction and hitting
 - > **Anatomically** designed with ventilation zones for increased comfort

Compression Support



PCS 2
Category D10

CODE	SIZE
83136	JR
83137	SR

<p>83287</p> <ul style="list-style-type: none"> > Length: 62cm > Padding: Neoprene <p>Weight 6Kg</p>	<p>Arm Blaster</p> <p>Category F1</p>
---	--

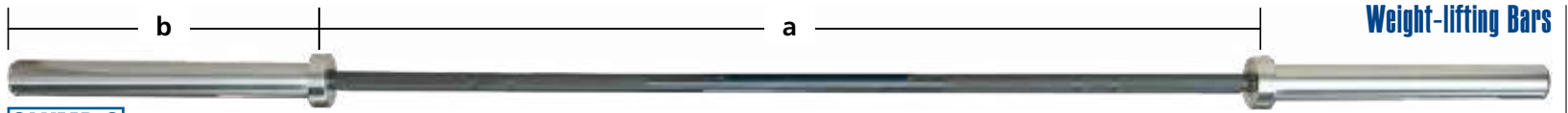

Weight-lifting Bars

OLYMPIC SIZE

> Without collar

Bench press only

Category F1

CODE	LENGTH	HEAT TREATMENT	BEARINGS	MATERIAL	COVER HANDLE/ SLEEVES	HANDLE (A)	SLEEVE (B)	MAX STRENGTH	PSI	WEIGHT	
44359	220cm	✓	—	Q235# Steel	Chrome/Chrome	Ø28.0x1320mm	Ø50x430mm	700lbs	34.000	20kg	
44357				45# Steel		Ø30.0x1320mm		1000lbs			
44393				45# Steel		Ø32.0x1320mm		1200lbs			
80032	160cm	✓	—	Q235# Steel	Chrome/Chrome	Ø28.0x1040mm	Ø50x280mm	700lbs	34.000	12kg	
80031	180cm					Ø28.0x1070mm				Ø50x365mm	13kg
80030	200cm					Ø28.0x1270mm					15kg

84534

OLYMPIC SIZE

Weight-lifting Bar

"Z" shaped, ideal for training

- > Without collar
- > Ø50mm x 145cm
- > b = 17cm



Weight 9 Kg Category E1

44373

OLYMPIC SIZE

Weight-lifting Bar

"W" shaped, ideal for training

- > Without collar
- > Ø50mm x 145cm
- > a = 107cm
- > b = 19cm
- > Grip: Ø25mm
- > Cover: Enameled
- > Lock: Screw
- > Max strength: 287lb / 130kg

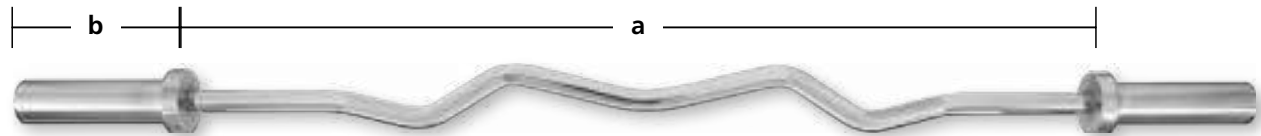

Weight 9,7 Kg Category E1

94252

OLYMPIC SIZE

Swiss Bar

- > Tube: 50x25x2,5mm
- > Length: 2m
- > Sleeves: 4mm thick, hard-chrome covered
- > Grips: 30mm diameter



Capacity 300kg Weight 16Kg Category F1

84729

**OLYMPIC
SIZE**

- > **Material:** Steel alloy
- > **Cover:** Hard chrome
- > **Bearings:** 6 x needle, brass bushing
- > **Handle:** Ø25mm
- > **Sleeve:** Ø50
- > **Length:** 220cm
- > **PSI:** 160.000
- > **Max strength:** 1000lb/453,6kg

According to the official specs for
WOMEN'S COMPETITION

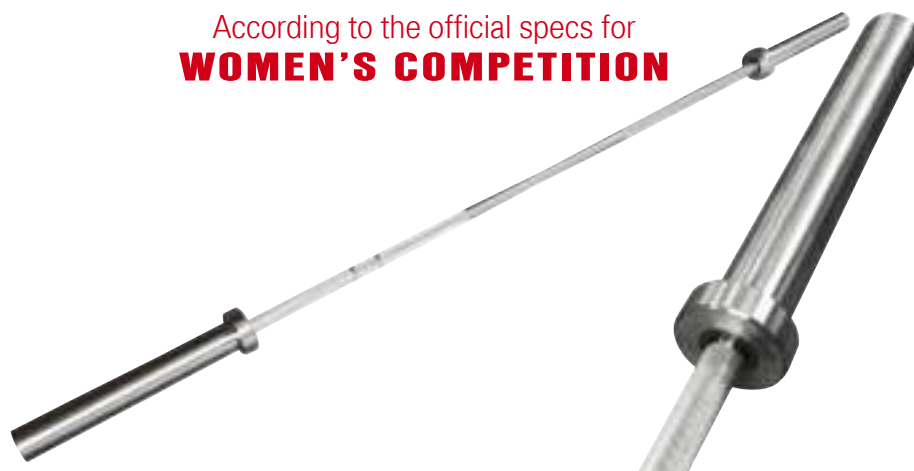

Women's Competition Bar

With grooved sleeves

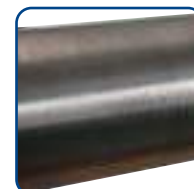

Weight
15 Kg

Category
F1

84730

**OLYMPIC
SIZE**

- > **Sleeve:** Aluminum and steel
- > **Cover:** Chrome
- > **Bearings:** 2 x ball, copper bushing
- > **Handle =** Ø28mmx1030cm
- > **Sleeve =** Ø50x400cm
- > **Length:** 183cm
- > **PSI:** 50.000



Smaller weight, specially designed for
TRAINING



Training Bar

In order to be able to learn the correct body positioning and movements without risking injuries

Weight
7 Kg

Category
F1

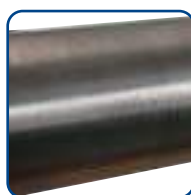

With grooved sleeves

- + They assist in keeping plates in place better when you're not using a collar
- + When using collars, the grooves can significantly help keep some of them from slipping, mostly spring clips or with rubber padding
- They make a zip noise when loading and unloading plates

**OLYMPIC
SIZE**



CrossFit

Category
F1

CODE	LENGTH	HEAT TREATMENT	BEARINGS	MATERIAL	COVER HANDLE/ SLEEVES	HANDLE (A)	SLEEVE (B)	MAX STRENGTH	PSI	WEIGHT
80041*	218cm	✓	8xNeedle	Steel (alloy)	Hard Chrome	Ø28.0x1320mm	Ø50x430mm	1.500lbs	200.000	20kg

* Exceptional chrome coating, offering superior protection from corrosion

* Bar #80036 without grooves on the sleeves

CrossFit

Category
F1

CODE	LENGTH	HEAT TREATMENT	BEARINGS	MATERIAL	COVER HANDLE/ SLEEVES	HANDLE (A)	SLEEVE (B)	MAX STRENGTH	PSI	WEIGHT
80047	220cm	✓	—	Steel (alloy)	Hard Chrome	Ø30.0x1310mm	Ø50x445mm	1.500lbs	200.000	20kg
80036*			4xNeedle	Spring Steel	Chrome	Ø28.0x1310mm		1.500lbs		

Stainless-Steel Bars

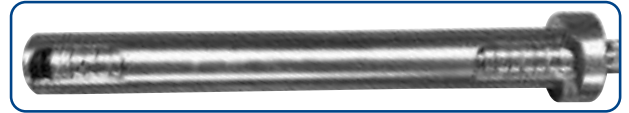
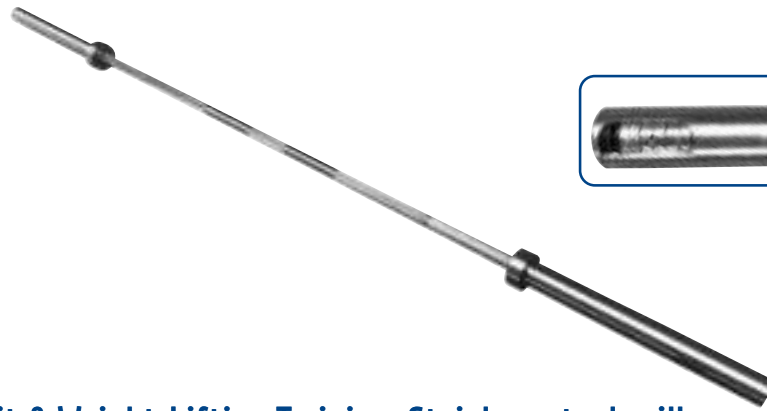

OLYMPIC SIZE

Category F1

CrossFit & Weight-Lifting Training, Stainless steel, will never rust!!!

CODE	LENGTH	HEAT TREATMENT	BEARINGS	MATERIAL	COVER HANDLE/ SLEEVES	HANDLE (A)	SLEEVE (B)	MAX STRENGTH	PSI	WEIGHT
80028	220cm	—	8 x Βελόνες	Ανοξείδωτο ατσάλι	—	Ø29.0x1310mm	Ø50x445mm	1.500lbs	200.000	20kg
80029						Ø28.0x1310mm				

Can be dropped from a height (on the condition that a suitable floor is used (#44489) along with the proper CrossFit disks)

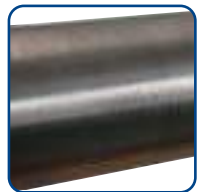

With grooved sleeves



Code #80034 with **camo** print on the handle

OLYMPIC SIZE

Category F1



Polymer-ceramic and QPQ coated Bars

QPQ is a chemical process applied twice, with an in-between polishing stage. It increases the item's properties against wear, corrosion, fatigue strength, while increasing lubricity. More than 10 times better performance than chromed or nickeled finishings.

The **Polymer-Ceramic Composite coating** enhances a number of physical performance properties including abrasion/wear resistance, corrosion resistance, chemical resistance, impact strength, and hardness. It is the ultimate protection that can be applied to surfaces that are corroded by sweat or weather, with many applications, especially in the field of military weapons.

CrossFit, polymer-ceramic coating on the handle, QPQ on the sleeves

CODE	LENGTH	HEAT TREATMENT	BEARINGS	MATERIAL	COVER HANDLE/ SLEEVES	HANDLE (A)	SLEEVE (B)	MAX STRENGTH	PSI	WEIGHT
80034	220cm	✓	8xNeedle	Steel (alloy)	Ceramic/QPQ	Ø28.0x1310mm	Ø50x445mm	1.500lbs	200.000	20kg
80044						Ø29.0x1310mm				
80049			Ø30.0x1310mm			1.000lbs	160.000			
80045			4xNeedle							

94251

OLYMPIC SIZE

- > **Sleeves:** Hard chrome covered
- > **Max strength:** 1.500lbs
- > **Colors:** Without



4 difficulty levels



Safe Squat Transpose Bar

Squat bar to perform 6 different exercises in 4 difficulty levels



6 different exercises

Weight 25Kg Length 228cm Category F1

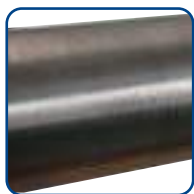

With grooved sleeves



Hard Chrome coated barbells have adequate anti-rust protection, while maintaining a fairly low price, making them the most attractive to buy.

Hard Chrome Bars

OLYMPIC SIZE

Category F1

Hard Chrome on the handle and the sleeves

CODE	LENGTH	HEAT TREATMENT	BEARINGS	MATERIAL	COVER HANDLE/SLEEVES	HANDLE (A)	SLEEVE (B)	MAX STRENGTH	PSI	WEIGHT
80039	203cm	✓	4x Needle	Steel (alloy)	Hard Chrome	Ø25.0x1310mm	Ø50x360mm	1.000lbs	160.000	15kg

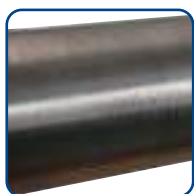

With grooved sleeves



Black Oxide barbells have the lowest resistance to oxidation and will require more care and maintenance to preserve their appearance than other barbells.

Black Oxide Bars

OLYMPIC SIZE

Category F1

Black Oxide on the handle and the sleeves

CODE	LENGTH	HEAT TREATMENT	BEARINGS	MATERIAL	COVER HANDLE/SLEEVES	HANDLE (A)	SLEEVE (B)	MAX STRENGTH	PSI	WEIGHT
80042	220cm	✓	8x Needle	Steel (alloy)	Black Oxide	Ø28.0x1310mm	Ø50x445mm	1.500lbs	200.000	20kg
80038	201cm		4x Needle			Ø25.0x1310mm	Ø50x350mm	500lbs	130.000	15kg
80037	203cm		—			Ø50x360mm				

94250

OLYMPIC SIZE

- > **Form:** Greatly assists you to perform squats without worrying about whether your posture is correct or not, extremely useful to experienced squatters
- > **Sleeves:** Olympic size, 5° angle to not let the plates slip
- > **Tube:** 50x5mm
- > **Length:** 2209mm
- > **Grips:** 30°



Safe Squat Bar

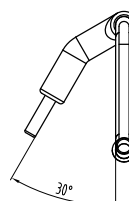
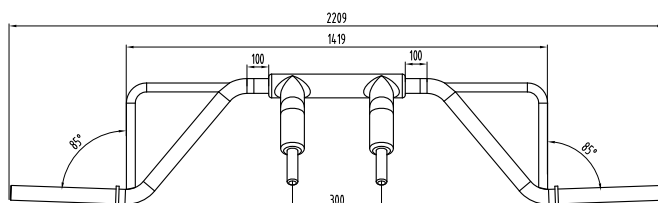

Weight 28kg Category F1

95129

- > **Material:** 18mm Plywood
- > **Heights:** 7, 15, 30 & 38cm



- > **Adjustable:** Four (4) different heights, allowing for precise adjustment of the height

Weight 180Kg Capacity 200Kg Category F2



JerK Block

90x50cm

95139

- > **Material:** Outer: Vinyl, Inner: PU foam

Crash Pad



PCS 2 Category F1

80x60x21cm

- Better range of motion while squatting
- Activates the quadriceps
- Protects and strengthens the knees

Squat Wedges



- > **Material:** 3mm thick steel

Capacity 400Kg TMX 2 Category E6

CODE	ANGLE
95304	10°
95305	20°
95306	30°

41990

- > **Digits:** 6, 10cm tall
- > **Material:** Mat aluminium
- > **Power:** DC 12V
- > **Remote:** Yes

Crossfit Timer



- > **Functions:** Clock, Intervals, Count-up and 100min, Count-down and 20min, Fight Gone Bad, Tabata, Timer, 10sec count.

- > **Memories:** To store custom programs

Category F1

63,8x16x5cm

41910

Pocket Gym Timer

With rechargeable battery and magnets on the back

- > **Screen:** LED with adjustable brightness
- > **Functions:** 7 = clock, countdown, goal timer, interval training, Tabata, FGB (Fight Gone Bad) or simple timer
- > **Speaker** for sound alerts on changes and when you reach your goals
- > **Magnets** on the back to place on metal surfaces
- > **Charging cable:** USB Type C (included)
- > **Charging time:** 3 hours
- > **Usage time:** Up to 10 hours



Weight 140gr Category F1

15,5x4,8x2,2cm

Weight-lifting floor

44489

- > **Dimensions:** 2,5x2 m, 3cm thick
- > **Rubber mat:**
8 pcs 3x50x25cm
& 8 pcs 3x50x50cm
- > **Wood:** 2x1m



Category D10

95302

Chalk Container

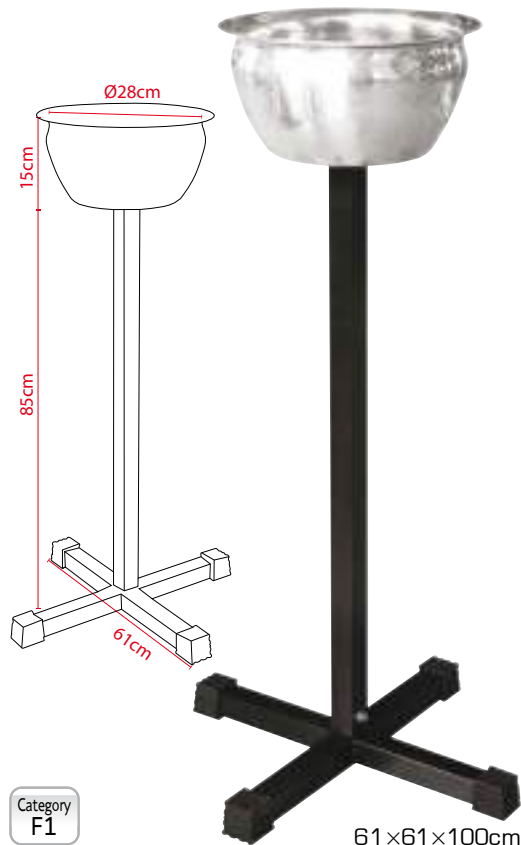

Category F1

61x61x100cm

95301

Chalk Powder

In net



Weight 60gr

Std Pack 35

Category F1

95303

Chalk Powder

In plastic jar



Weight 300gr

Std Pack 40

Category F1

Liquid Chalk



Category F1

CODE	QUANTITY
95312	50ml
95313	100ml
95314	200ml

90401

> Tube: 50x2mm



Category F2

Bar Jack

43946

> Tube: Oval 80x40x1,8mm



Barbell Rack

Weight 38 Kg Strength 250 Kg Category F1

106x90x126cm



Barbell

PU covered disks

Category F1

CODE	WEIGHT	CODE	WEIGHT
84711	10,00 Kg	84715	30,00 Kg
84712	15,00 Kg	84716	35,00 Kg
84713	20,00 Kg	84717	40,00 Kg
84714	25,00 Kg	84718	45,00 Kg

> Material: 70% recycled rubber
> Shape: Hexagon

Barbell Set

Recycled rubber discs



Category Z6

CODE	WEIGHT	CODE	WEIGHT
84721	10,00 Kg	84725	30,00 Kg
84722	15,00 Kg	84726	35,00 Kg
84723	20,00 Kg	84727	40,00 Kg
84724	25,00 Kg	84728	45,00 Kg

> Material: Recycled rubber
> Shape: Hexagon

Barbell Set

Recycled rubber discs



Category Z6

CODE	WEIGHT	CODE	WEIGHT
84791	10,00 Kg	84795	30,00 Kg
84792	15,00 Kg	84796	35,00 Kg
84793	20,00 Kg	84797	40,00 Kg
84794	25,00 Kg	84798	45,00 Kg

43931

Barbell Rack



Category F1

114x84x140cm

44377 Bar with Handles

> Usage: Back

Length 85cm Weight 5 Kg Std Pack 5 Category E1



44374

Length 61cm Weight 4.20Kg Category E1

44384 Bar with Handles

> Usage: Back



Length 86cm Weight 5.11Kg Std Pack 10 Category E1

44381 Triceps Bar

> Usage: Triceps



Length 51cm Weight 2.22Kg Std Pack 10 Category E1

96629 Multi-grip Soft-strap Tricep Rope

> Usage: Back, Biceps, Triceps

> Ring: "D" shaped

> Length: 56cm on the short grips, 70cm on the long ones



44385 Bar

> Usage: Lower back



Length 95cm Weight 17.1Kg Std Pack 15 Category E1

44378 Triceps Bar

> Usage: Triceps



Length 71cm Weight 3.00Kg Std Pack 10 Category E1

44386 Triceps Bar

> Usage: Outter triceps



Length 55cm Weight 2.57Kg Std Pack 25 Category E1

Inner padding for a more comfortable use

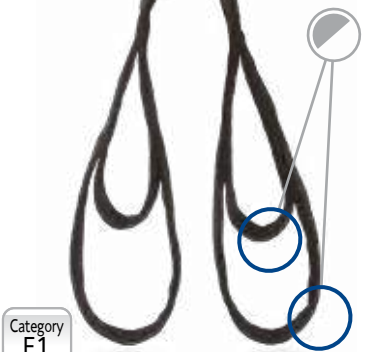

Category E1

44388 Rowing Bar

> Usage: Back



Length 40cm Weight 3.10Kg Std Pack 20 Category E1

44380 Triceps Bar

> Usage: Outter triceps



Length 22cm Weight 1.62Kg Std Pack 25 Category E1

44387 Rowing Bar

> Usage: Back



Length 18cm Weight 1.93Kg Std Pack 30 Category E1

44382 Rowing Rubber covered grips

> Usage: Back



Weight 2Kg Category E1

44361 Triceps Bar

> Collar: Straight

> Dimensions: Ø50mm x 87cm

OLYMPIC SIZE



Weight 9.50Kg Category E1

44367 Triceps Bar

> Collar: Screwed

> Dimensions: Ø28mm x 85,5cm



Weight 8.57Kg Category E1

44389 Crossover Grip



Length 15cm Weight 0.67Kg Std Pack 30 Category E1

44383 Triceps Rope



Weight 0,8Kg Category E1



- > **Material:** Steel
- > **Cover:** PU
- > **Grip:** Chromed, 15cm long, 3,22cm diameter, knurl with diamond motif

Category
F1

PU Covered Dumbbells with Chromed Handle

CODE	WEIGHT
94350	2,00 Kg
94351	2,50 Kg
94352	4,00 Kg
94353	5,00 Kg

CODE	WEIGHT
94354	6,00 Kg
94355	7,50 Kg
94356	8,00 Kg
94357	10,00 Kg
94358	12,50 Kg
94359	15,00 Kg
94360	17,50 Kg
94361	20,00 Kg
94362	22,50 Kg
94363	25,00 Kg
94364	27,50 Kg
94365	30,00 Kg
94366	35,00 Kg
94367	40,00 Kg
94368	45,00 Kg
94369	50,00 Kg



> **Cover:** TPU

CODE	WEIGHT
90621	2,50 Kg
90622	5,00 Kg
90623	7,50 Kg

TPU covered Dumbbells

CODE	WEIGHT
90624	10,00 Kg
90625	12,50 Kg
90626	15,00 Kg
90627	17,50 Kg
90628	20,00 Kg
90629	22,50 Kg
90630	25,00 Kg
90631	27,50 Kg
90632	30,00 Kg

PCS
1

Category
E1

Rubbered Covered Dumbbells with Chromed Grip



CODE	WEIGHT
84520	2,50 Kg
84521	5,00 Kg
84522	7,50 Kg
84523	10,00 Kg
84524	12,50 Kg
84525	15,00 Kg
84526	17,50 Kg
84527	20,00 Kg

CODE	WEIGHT
84528	22,50 Kg
84531	30,00 Kg
84533	35,00 Kg
84734	40,00 Kg

- > **Quality:** High, high durability
- > **Material:** 100% primary
- > **Smell:** None

Category
F1

Dumbbells

Hexagonal, rubber coated



CODE	COLOR	WEIGHT
90588	Yellow	7,50 Kg
90589	Green	8,00 Kg
90590	Green	9,00 Kg
90591	Green	10,00 Kg
90592	Blue	12,50 Kg
90593	Blue	15,00 Kg
90594	Blue	17,50 Kg
90595	Red	20,00 Kg
90596	Red	22,50 Kg
90597	Red	25,00 Kg
90598	Orange	27,50 Kg
90599	Orange	30,00 Kg
90600	Orange	32,50 Kg
90601	Grey	35,00 Kg
90602	Grey	37,50 Kg
90603	Black	40,00 Kg

CODE	COLOR	WEIGHT
90580	Yellow	1,00 Kg
90581	Yellow	2,00 Kg
90582	Yellow	2,50 Kg
90583	Yellow	3,00 Kg
90584	Yellow	4,00 Kg
90585	Orange	5,00 Kg
90586	Orange	6,00 Kg
90587	Orange	7,00 Kg

- > **Material:** Primary rubber, high durability

- + Stainless steel [not cast iron]
- + High durability
- + The Q235 steel shaft is tightened in a unique way
- + Rubber anti-slip covered shaft
- + Will not rust

Category
E1



Dumbbells
Hexagonal,
rubber coated

- > **Quality:** Medium/Low
- > **Material:** 70% recycled, 30% primary
- > **Smell:** None to slight

Category
F1

CODE	WEIGHT
84535	2,00 Kg
84764	3,00 Kg
84536	4,00 Kg
84765	5,00 Kg
84537	6,00 Kg
84766	7,00 Kg
84538	8,00 Kg
84767	9,00 Kg

CODE	WEIGHT
84539	10,00 Kg
84540	12,50 Kg
84541	15,00 Kg
84542	17,50 Kg
84543	20,00 Kg
84544	22,50 Kg
84545	25,00 Kg
84546	27,50 Kg
84547	30,00 Kg
84548	32,50 Kg
84549	35,00 Kg
84598	37,50 Kg
84599	40,00 Kg
84698	45,00 Kg
84699	50,00 Kg



Dumbbells
Hexagonal,
rubber coated

- > **Cover:** 70% recycled,
30% primary

Category
F1

CODE	WEIGHT
90562	14,00 Kg
90563	16,00 Kg

CODE	WEIGHT
90564	18,00 Kg
90566	22,00 Kg
90567	24,00 Kg

Vinyl Dumbbells
LOWER QUALITY



CODE	COLOR	WEIGHT
90502	Pink	1,50 Kg
90503	Orange	2,00 Kg
90504	Teal	2,50 Kg
90505	Red	3,00 Kg
90506	Grey	4,00 Kg
90507	Black	5,00 Kg

> Cover: Vinyl

PCS 1 Category E1

44490

Rack

For 6 dumbbells



Category D7

> Anatomic grip
> Cover: Neoprene

Soft Dumbbells



CODE	COLOR	WEIGHT
44448	Red	2x 1,00 Kg
44449	Blue	2x 2,00 Kg
44450	Green	2x 3,00 Kg

Price per pair

PCS 2 Category E1

Vinyl Dumbbells



CODE	COLOR	WEIGHT
44491	Pink	1,00 Kg
44127	Purple	1,50 Kg
44492	Orange	2,00 Kg
44493	Red	3,00 Kg
44409	Yellow	4,00 Kg
44494	Cyan	5,00 Kg
44120	Blue	6,00 Kg
44121	Pink	7,00 Kg
44122	Grey	8,00 Kg
44123	Blue	9,00 Kg
44124	Black	10,00 Kg

> Cover: Vinyl
> Filling: Cast iron
> Packaging: Plastic bag

PCS 1 Category E1

Plastic Dumbbells



CODE	COLOR	WEIGHT
44530	Red	2x 1,00 Kg
44531	Blue	2x 2,00 Kg
44534	Cyan	2x 3,00 Kg
44535	Purple	2x 4,00 Kg
44536	Grey	2x 5,00 Kg

PCS 2 Category E1

> **Usage:** For Personal Training, especially for women and physical restoration. Not suitable for Crossfit gyms and Bodybuilding Clubs

Kettlebell Cordura



- + Wide grip
- + Very soft
- + They don't damage the floor
- + Competitive price

> **Material:** Cordura

CODE	WEIGHT
84778	4,00 Kg
84779	6,00 Kg
84880	8,00 Kg
84881	10,00 Kg

> **Usage:** For Personal Training, especially for women and physical restoration. Not suitable for Crossfit gyms and Bodybuilding Clubs

Kettlebell PVC



- + Wide grip
- + Very soft
- + They don't damage the floor
- + Competitive price

> **Material:** PVC

CODE	WEIGHT
84774	4,00 Kg
84775	6,00 Kg
84776	8,00 Kg
84777	10,00 Kg
84773	12,00 Kg



> **Material:** Nodular cast iron
 > **Cover:** 100% natural rubber
 > **Packaging:** Box

- + Thick and anti-slip grip
- + Full covered by rubber, will not rust

Category E1



Kettlebell Original Rubber

CODE	COLOR	WEIGHT
90473	White	4,00 Kg
90474	White	6,00 Kg
90475	Red	8,00 Kg
90476	White	10,00 Kg
90477	Blue	12,00 Kg
90478	Yellow	16,00 Kg
90479	Purple	20,00 Kg
90480	Green	24,00 Kg



- + Non-slip handles
- + Suitable for susceptible floors
- + For use by women
- + Resistance to moisture, they do not rust
- Large size



Plasticized Kettlebells Big variety of colors

> **Material:** Cement and iron filings
 > **Handle:** Plastic

> **Base:** Rubber pads protect the floor

CODE	COLOR	WEIGHT
84690	Red	2,00 Kg
84694	Blue	3,00 Kg
84691	Yellow	4,00 Kg
84695	Green	5,00 Kg
84692	Purple	6,00 Kg
84693	Orange	8,00 Kg

Category E1

Rubber Covered Kettlebell & Chrome Grip

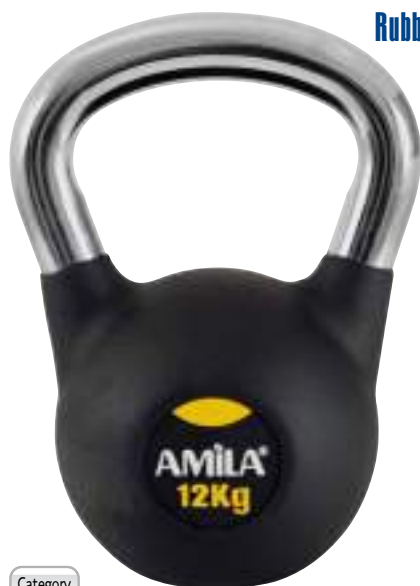

> **Coating:** Black natural rubber for absolute protection

CODE	WEIGHT
44495	4,00 Kg
44571	6,00 Kg
44496	8,00 Kg
44572	10,00 Kg
44497	12,00 Kg
44498	16,00 Kg
44499	20,00 Kg
44573	24,00 Kg

Category E1

Rubber Covered Kettlebell & Chrome Grip



> **Coating:** Black natural rubber for absolute protection

CODE	WEIGHT
90452	2,00 Kg
90453	4,00 Kg
90455	8,00 Kg
90456	10,00 Kg
90457	12,00 Kg
90458	14,00 Kg
90460	20,00 Kg

Category E1

Vinyl Covered Kettlebell

Big variety of colors

HIGH QUALITY

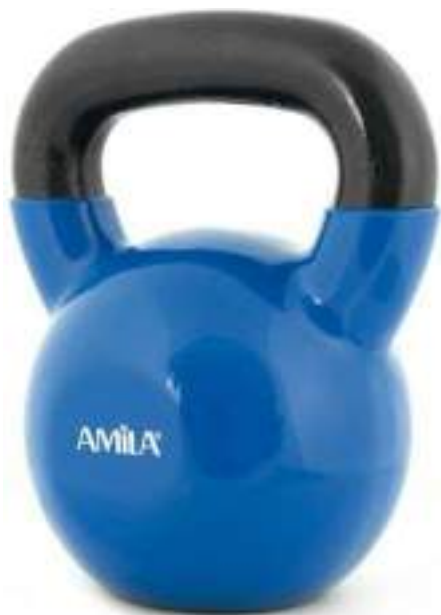

CODE	COLOR	WEIGHT
44504	Red	4,00 Kg
44505	Yellow	8,00 Kg
44506	Green	12,00 Kg
44507	Blue	16,00 Kg
44509	Black	20,00 Kg

Category E1

Kettlebell



> **Material:** Cast iron
> **Handle:** Wide and extured

CODE	WEIGHT
44680	4,00 Kg
44681	6,00 Kg
44682	8,00 Kg
44683	10,00 Kg
44684	12,00 Kg
44685	16,00 Kg
44686	20,00 Kg

Category E1

Enameled Kettlebell



> **Base:** Special rubber base to protect the floor



CODE	WEIGHT
44500	4,00 Kg
44521	6,00 Kg
44501	8,00 Kg
44522	10,00 Kg
44502	12,00 Kg
44503	16,00 Kg
44508	20,00 Kg
44510	24,00 Kg

Category E1

Η κατασκευή ενός **αγωνιστικού kettlebell** απαιτεί εξειδικευμένη γνώση και εμπειρία που πολύ λίγα εργοστάσια την κατέχουν.

Το **Kettlebell Sport**, είναι ένα άθλημα δύναμης όπου ο νικητής ανακηρύσσεται όχι με βάση το μέγιστο βάρος που μπορεί να σηκώσει για μία επανάληψη, αλλά με βάση το **μέγιστο αριθμό επαναλήψεων** που μπορεί να εκτελέσει ή το **συνολικό βάρος** (αριθμό επαναλήψεων x βάρος του kettlebell) που μπορεί να σηκώσει με μία από τις αγωνιστικές άρσεις μέσα σε συγκεκριμένο χρονικό διάστημα (συνήθως δέκα λεπτών).

Το κλασικό Kettlebell Sport, γνωστό και ως **Girevoy Sport**, έχει ανακηρυχτεί επισήμως σε εθνικό άθλημα της Ρωσίας το 1974. Σήμερα, υπάρχουν παραλλαγές του Kettlebell Sport (το Girevoy Sport, το άθλημα BOLT που προωθεί κατά αποκλειστικότητα η International Kettlebell Lifting Federation και οι Μαραθώνιοι ή ημι-μαραθώνιοι αγώνες με kettlebell) διαδίδονται σε όλο τον κόσμο.



Τα **Αγωνιστικά Kettlebell** είναι στο **ίδιο μέγεθος ανεξαρτήτως βάρους**

Εσωτερικό Υλικό (Γέμιση)

Το αγωνιστικό kettlebell είναι φτιαγμένο από χυτο σίδηρο (μαντέμι). Το εσωτερικό του είναι κενό, λόγω του κενού είναι διαφορετικός για κάθε διαφορετικό βάρος. Ανάλογα με το βάρος του kettlebell χρησιμοποιείται διαφορετικό υλικό.

Δεν υπάρχει άλλη εργαλείο ή πόνησης εκτός από τα kettlebells που να εστιάζει σε όλες τις φυσικές μεταβλητές που χρειάζεται ο αθλούμενος στις πολεμικές τέχνες, ώστε να γίνει ένας πλήρως κληρωμένος αθλητής.

- Στα **βαριά** kettlebell το κενό είναι γεμάτο με μολύβι.
- Στα **μεσαία** βάρη είναι γεμάτο με σίδηρο.
- Στα **ελαφριά** βάρη είναι γεμάτο με ένα μίγμα παρόμοιο με διγλυκωμένη πολυουρεθάνη υψηλής πυκνότητας, ώστε το υλικό να είναι συμπαγές και να αντέχει στις κρούσεις.



Tip *

Τα αγωνιστικά kettlebells είναι **κούφια στο εσωτερικό** τους. Γεμίζονται με **έρμα** (μεταλλικά σφαιρίδια διάφορου βάρους και μεγέθους), χωρίς να περισσεύει καλύπτεται από μεταλλικό υλικό που γεμίζει τα κενά και δεν επιτρέπει στο έρμα να κινείται.



Category F1

Competition Kettlebell

One size, various weights



SCAN HERE

to view a sample video of exercises on our YouTube channel.

CODE	COLOR	WEIGHT
84581		8,00 Kg
84582		12,00 Kg
84583		16,00 Kg
84584		20,00 Kg
84585		24,00 Kg
84586		28,00 Kg
84587		32,00 Kg
84588		36,00 Kg

CLUBBELL



Stand out!

Training with ClubBells is done with many different kinds of swings, which may appear to be a variation of traditional kettlebells. However, even though they belong to the same family, the **long neck**, the **unbalanced weight** and the **multiple movement levels** make ClubBells unique, offering **many benefits that can't be obtained as effectively any other way**.

Strength, Concentration and Balance

Through a single swing, the **huge range of motion** and the imbalance caused by the **movement of the center of gravity throughout the whole body**, requires the **use of multi-joint movements** aimed at **strengthening multiple muscle groups**, helping to **improve the stabilising muscles**.

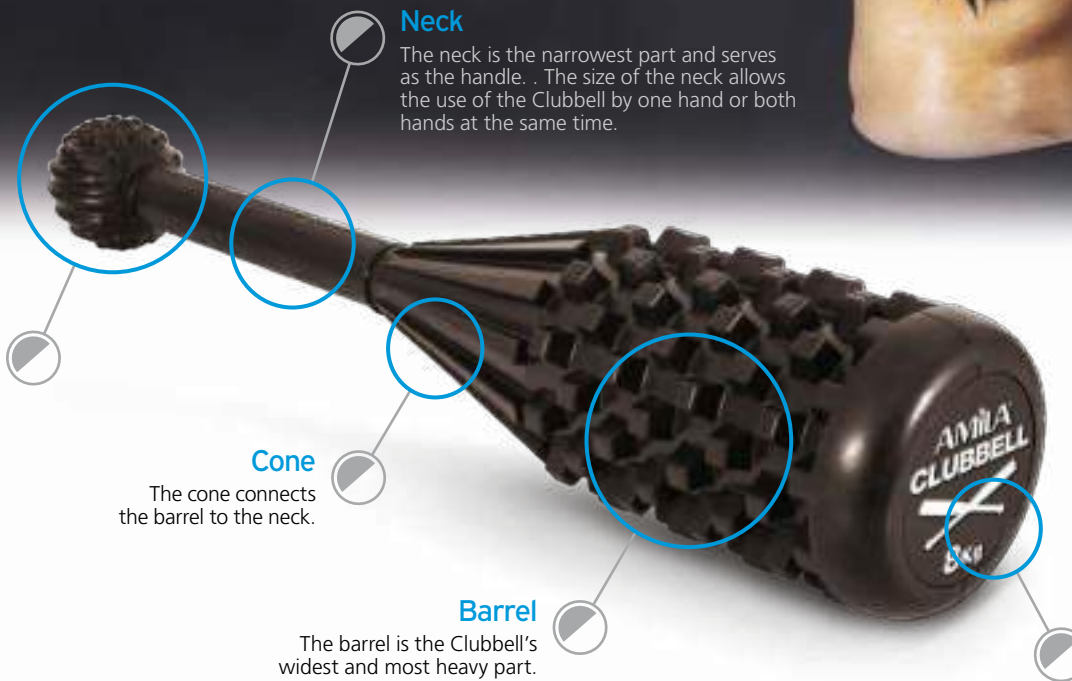

Knob

The knob prevents slippage from your hand.

Neck

The neck is the narrowest part and serves as the handle. The size of the neck allows the use of the Clubbell by one hand or both hands at the same time.

Cone

The cone connects the barrel to the neck.

Barrel

The barrel is the Clubbell's widest and most heavy part.

Muzzle

The muzzle resides at the end of the Clubbell. It is flat, allowing the Clubbell to stand upright.

New-Innovative Exercises

During the past years, exercises using pins, clubs or other longitudinal weights were meant to help improving performance in spears, swords and other weapons. Their use has been minimal in modern times, mainly in Asia (for local sports using swords, rattles etc.) and for sports as baseball and cricket, as a specialized routine.



CODE	WEIGHT	DIMENSIONS
91902	2,00 Kg	Ø 6 × 40 cm
91903	4,00 Kg	Ø 8 × 41,5 cm
91904	6,00 Kg	Ø 10 × 51,5 cm
91905	8,00 Kg	Ø 10 × 54 cm
91906	10,00 Kg	Ø 12 × 55,5 cm
91907	12,00 Kg	Ø 12 × 55,5 cm

MS704001

- > To be used as the connecting attachment of the storage platform, both sides can be connected with the storage rack
- > **ONLY** to be used with MS704002-MS7040005 storage shelves below

Weight
20.2kg

Category
F2

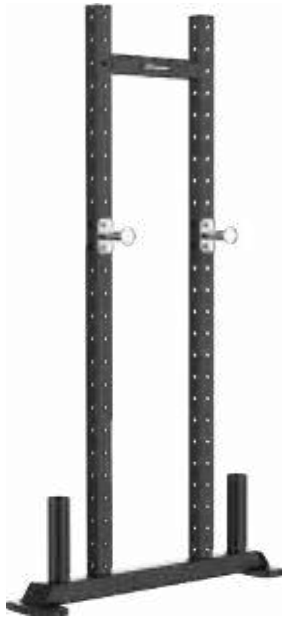

Storage Rack Frame
MS704001



156×87×21cm

MS704004

- > Can meet all kinds of ball props such as rhythm ball, wall ball, medicine ball and other storage needs.
- > **ONLY** to be used with MS704001 frame in order to create a storage rack

Weight
14.9kg

Category
F2

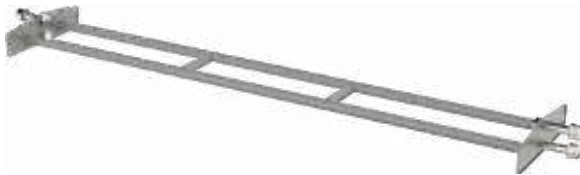

39×202×11cm

Ball Storage
MS704004

MS704005

- > It can meet the storage needs of dumbbells of various specifications.
- > **ONLY** to be used with MS704001 frame in order to create a storage rack

Weight
25kg

Category
F2



39×202×11cm

Dumbbell Storage
MS704005

MS704002

- > It can meet the storage needs of weight plate of various specifications.
- > **ONLY** to be used with MS704001 frame in order to create a storage rack

Weight
20kg

Category
F2



39×202×29cm

Bumper Plate Storage
MS704002

MS704003

- > It can meet the storage needs of various props and, at the same time, used as a storage platform for other tools.
- > **ONLY** to be used with MS704001 frame in order to create a storage rack

Weight
36.8kg

Category
F2



44×202×11cm

Kettlebell Storage
MS704003

Barbell and Disc Rack

91351

FULL Commercial Grade

> Tube: 70x50x2mm



Weight 60Kg Strength 500kg Category F1

43959

Plate Rack

> Length: 25cm

> Tube: Oval 80x40x1,8mm
> Can be used with 45cm diameter plates

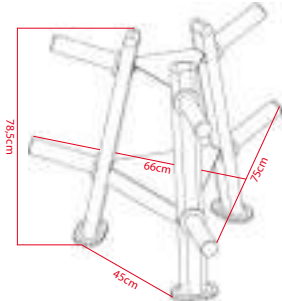

Weight 14 Kg Capacity 300 Kg Category D7

43936

Plate Rack

> Tube: 60x60x2mm
> Wheels: For easy transport



Weight 20Kg Capacity 350Kg Category E1

75x60x120cm

43949

Plate Rack

> Tube: Oval 70x30x1,8mm



Weight 11 Kg Capacity 250 Kg Category D7

52x70x88cm

43935

Plate Rack

> Tube: 45x45x2mm
> Capacity:
1,25kg x 4 pcs, 2,50kg x 2 pcs
5,00kg x 2 pcs, 10,00kg x 2 pcs
15,00kg x 2 pcs, 20,00kg x 2 pcs
25,00kg x 2 pcs

• Easy to transport due to the handle and the integrated wheels



Weight 16Kg

Category E1

146x34x28cm

43944

Pump Set Rack

- > **Tube:** Oval 80x40x1.8mm
- > For 10 sets



75x66x157cm

Category D7

91352

Pump Set Rack

- > **Main tube:** 80x40x1.8mm & 60x30x1.5mm
- > You can store collars on the vertical receptacles on the back
- > For disks with a hole of Ø25mm diameter or more



113x56x85cm

43943

Pump Set Rack

- > **Tube:** Oval 80x40x1.8mm
- > For 30 sets



153x80x150cm

Weight 57 Kg

Category D7

91354

OLYMPIC SIZE

Barbell Floor Rack

- > **Main tube:** 60x60x2mm



45x45x23cm

FULL Commercial Grade

91353

OLYMPIC SIZE

Barbell Floor Rack

- > **Main tube:** 80x40x1.8mm & 50x50x2mm



70x63x26cm

43950

For Personal Training

Plate Rack

- > **Diameter:** 28mm
- > **Max weight:** 100kg
- Light colored



72x38x91cm

43953

OLYMPIC SIZE

- > **Diameter:** 50mm
- > **Max weight:** 150kg
- Dark colored



Weight 8 Kg

Category D7

43934

OLYMPIC SIZE

Barbell Floor Rack

- > **Tube:** 50x50x2mm

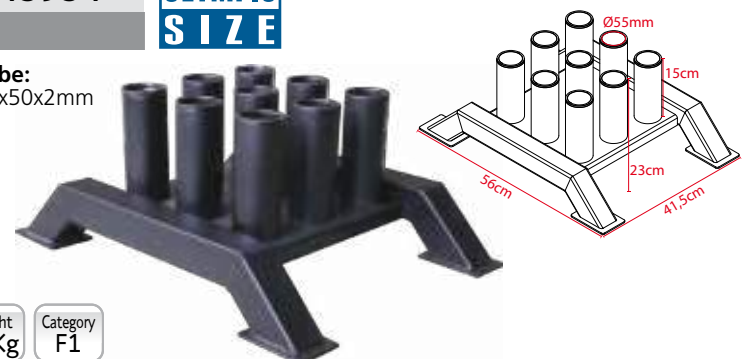

Weight 10Kg

Category F1

43946

Barbell Rack

> Tube:
Oval 80x40x1,8mm



Weight 38 Kg Strength 250 Kg Category F1

106x90x126cm

43931

FULL Commercial Grade

Barbell Rack



Strength 270 Kg Category F1

+ For bars 10 + 15 + 20 + 25 + 30 + 35kg

114x84x140cm

43952

Barbell Rack EX

> Max weight:
200kg

Semi-Commercial Grade



Weight 38 Kg Category F1

85x85x148.5cm

43933

Barbell Wall Rack

- Just bolt to the wall at your desired width and height
- > Material: Heavy duty 5mm steel
- > Rubber sleeve to protect the barbell sleeve



Weight 7Kg Category F1



14,5x7x106cm

43932

FULL Commercial Grade

Dumbbell Rack

- > **Tube:** 120x50x3mm
- > **Capacity:** About 50 dumbbells
- > **Very flexible:** Can be used for all different types of dumbbells and kettlebells



+ The height and incline of the shelves can be adjusted

Capacity 800 Kg | per shelf 250 Kg | Weight 84kg | Category F2

147x70x107cm

43937

Semi-Commercial Grade

Rack

- > **Tube:** 50x70x1.5mm
- > Suitable for small gyms
- > Can be used for dumbbells, kettlebell and disks on the bottom rack
- > Hanger for large loop bands



Capacity 600 Kg | per shelf 250 Kg | Weight 30kg | Category F1

171x62x128cm

43938

Rack

- > **Tube:** 50x70x2mm

The shelves are **DOUBLE-SIDED**, one for bumbells and the other for kettlebells and can be assembled any way you want



Capacity/shelve 250 Kg | Weight 32 Kg | Category F1

111x56x83cm

43954

Semi-Commercial Grade

Chromed Dumbbell Rack EX

- > **Max weight:** 150kg



Weight 31 Kg | Category F1

166x53x81cm

43958

Vinyl Dumbbell Rack

- > **Tube:** Square 50x2mm
- > For 60 vinyl dumbbells, weighting 0,5-10kg, three pairs of each weight



Weight 32 Kg Category D7

120x65x156cm

43957

Vinyl Dumbbell Rack

- > **Tube:** Square 45x1.5mm
- > For 20 vinyl dumbbells



Weight 10 Kg Category D7

64x53x118cm

43939

Dumbbell Rack

- > For 10 pairs



Capacity 300kg Weight 21 Kg Category F1

55x27x126cm

43945

Semi-Commercial Grade

Kettlebell Rack

- > **Tube:** Oval 80x40x1.8mm



Weight 36 Kg Category F1

120x52x85cm

43956

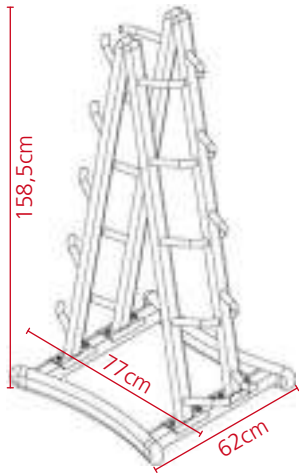
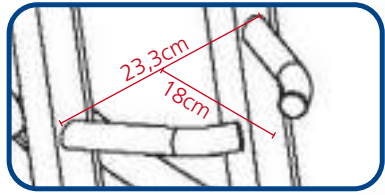

77x62x158,5cm

Category F1

Medicine Ball Rack

Semi-Commercial Grade



43928

Single Balance Ball Rack

- > **Frame:** Oval 80x40mm, 1,8mm thick
- > **Shelves:** Ø25x2mm
- > **Capacity:** 5 balls

+ Can also be used for Power Bags



67x80x170cm

Weight 35Kg

Category F1

43929

Double Balance Ball Rack

With wheels

- > **Frame:** Square 30x30mm, 1,5mm thick
- > **Capacity:** 14 balls



64x125x199cm

Category F1

- > **Material:** Canvas
- > **Filling:** Chromed dowels which do not rust

AMILA® Wrist/Ankle Weights

With Velcro.
Weight adjusted by dowels.



* Code #44144 with painted dowels

CODE	WEIGHT
44140	2x1,50 Kg
44141	2x2,00 Kg
44144*	2x2,50 Kg

27,5x15cm

PCS 2 Category E1

- > **Material:** Neoprene
- > **Filling:** Sand iron

AMILA® Wrist Weights

Ideal for training and physiotherapy



CODE	WEIGHT
44130	2x0,50 Kg
44131	2x1,00 Kg

PCS 2 Category E1

- > **Material:** Neoprene
- > **Filling:** Sand iron - Barite

Ankle & Wrist Weights

With Velcro



CODE	WEIGHT
44114	2x0,50 Kg
44115	2x1,00 Kg
44116	2x1,50 Kg

PCS 2 Category E1

- > **Material:** Nylon
- > **Filling:** Sand iron - Barite

Ankle & Wrist Weights

With Velcro.
Fixed (not adjustable).



CODE	WEIGHT
44168	2x4,00 Kg
44169	2x5,00 Kg

PCS 2 Category E1

44161

- > **Material:** Silicone
- > **Filling:** Iron



Wrist Weights

PCS 2 Weight 920gr Category E1

29.5x7.2cm



> **Material:** Nylon
 > **Filling:** Sand iron - Barite

- + Protects the body
- + Very soft
- + Nice feel



Ankle & Wrist Weights

With Velcro.
 Fixed (not adjustable).



CODE	WEIGHT
94954	2x2,50 Kg
94955	2x3,00 Kg

PCS 2
 Category E1

CODE	WEIGHT
94951	2x0,50 Kg
94952	2x1,00 Kg
94953	2x1,50 Kg

> **Adjustable weight**
 > **Fabric:** Neoprene
 > **Filling:** Iron sand bags

Wrist/Ankle Weights



CODE	WEIGHT
44149	2x2,50 Kg

PCS 2
 Category E1

> **Adjustable weight**

Ankle & Wrist Weights



CODE	WEIGHT
44105	2x2,50 Kg
44106	2x5,00 Kg

PCS 2
 Category E1

AMILA® HYDROBAG

Why should I use a HYDROBAG;

It is the perfect tool to help you correctly work-out your body and keep in shape! While it looks like an ordinary PowerBag, the use of water makes it unique!

The Power of Water

You can achieve a more intense and effective training when compared to traditional PowerBags. The water movement inside will energize your stabilizer muscles.

High Quality

Made of high quality PVC 1,0 mm thick for durability. Printed lines are useful when filling it with water to better calculate its weight, while at the same time you can use the pump to fill the remaining space with air.

Multiple handles

Equipped with four (4) anti-slip handles, with neoprene covering, to be able to exercise many muscle groups.

A safety valve prevents water leakage



INCLUDES
WATER COLOURING LIQUID

* Due to the elasticity of the material and the pressure of the pumped air, the dimensions are approximate.

> **Material:** Cordura with foam padding, double velcro and double zipper, barrel bag with double velcro



Category
F1

CODE	WEIGHT
90671	15 Kg
90672	20 Kg



CODE	WEIGHT	DIMENSIONS	COLOR
90661	15kg	Ø15x80cm	Red
90662	20kg	Ø18x82cm	Green
90663	35kg	Ø23x85cm	Blue

Category
F1

Soft Bags

Power Bag



> Grips: 4 grips for a bigger variety of exercises

> **Bag:** To be filled by sand and/or other materials. The bag is then placed inside the bucket; guaranteed leak proof and weight adjustment.

> **Outer surface:** Thick reinforced nylon fabric to prevent tearing. Reinforced straps for carrying out exercises. Zip closure. Transport handle.



> **Bucket:** Internal soft container to keep the sand unmovable and minimize injuries, bag fastened with straps.



> Grips: 2 grips

+ Superb durability

Category F1



> With 4 grips

CODE	COLOR	WEIGHT	LENGTH	DIAMETER
90675	Purple	5,00 Kg	50,0cm	18cm
90676	Green	10,00 Kg	54,5cm	22cm
90677	Yellow	15,00 Kg	54,5cm	22cm
90678	Blue	20,00 Kg	60,0cm	26cm
90679	Red	25,00 Kg	60,0cm	26cm



SCAN HERE to view a sample video of exercises on our YouTube channel.

> With 2 grips

CODE	COLOR	WEIGHT	LENGTH	DIAMETER
37320	Purple	5,00 Kg	50,0cm	18cm
37323	Blue	20,00 Kg	60,0cm	26cm
37324	Red	25,00 Kg	60,0cm	26cm

They should not be dropped!
ATTENTION: They are not Smash Bags. They are used during exercises which do not require to let the bag be dropped down.

Weight Bag



CODE	COLOR	WEIGHT
44661	Yellow	5,00 Kg
44662	Green	10,00 Kg
44663	Blue	15,00 Kg
44664	Red	20,00 Kg
44665	Black	25,00 Kg

57x22cm

Category F1



Category E3

ATTENTION: They are not Wall Balls. Not to be dropped down!

- > **Material:** 40% primary rubber
- > **Joins:** Glued
- Very grippy texture

“Grip” Medicine Ball

CODE	WEIGHT	DIAMETER	COLOR
84751	1,0 Kg	—	
84752	2,0 Kg	—	
84753	3,0 Kg	—	
84754	4,0 Kg	—	
84755	5,0 Kg	—	
84756	6,0 Kg	—	
84757	7,0 Kg	—	
84758	8,0 Kg	—	
84759	9,0 Kg	—	
84760	10,0 Kg	—	



Category E3

ATTENTION: They are not Wall Balls. Not to be dropped down!

- + Very nice tacky feeling

Medicine Ball

- > **Material:** Natural rubber
- > **Joins:** Glued

CODE	WEIGHT	DIAMETER	COLOR
90708	4,0 Kg	25,5cm	
90709	6,0 Kg		
90710	8,0 Kg		
90711	10,0 Kg		



> **Material:** Rubber
> **Joins:** Glued

Medicine Ball Rebound

- Soft feel and light rebound
- + The only ones that can be dropped down without being smash balls

Category
F1



SCAN HERE to view a sample video of exercises on our YouTube channel.

CODE	WEIGHT	DIAMETER	COLOR
44640	6,0 Kg	22,5cm	
44634	7,0 Kg	27,0cm	
44641	8,0 Kg	27,0cm	
44642	10,0 Kg	27,0cm	



ATTENTION: They are not Wall Balls. Not to be dropped down!

Medicine Ball

Category
E3

> **Material:** Rubber

CODE	WEIGHT	DIAMETER	COLOR
90704	4,0 Kg	24,0cm	
90705	5,0 Kg	28,6cm	



ATTENTION: They are not Wall Balls. Not to be dropped down!

**Dual Grip
Medicine Ball**

> **Material:** Rubber

CODE	WEIGHT	DIAMETER	COLOR
84676	3,0Kg	22,0cm	Blue
84677	4,0Kg	23,0cm	Pink
84678	5,0Kg	25,0cm	Green
84679	6,0Kg	26,0cm	Black
84673	8,0Kg	26,0cm	Black
84674	10,0Kg	28,0cm	Black
84675	12,0Kg	28,0cm	Black

Category
F1



ATTENTION: They are not Wall Balls. Not to be dropped down!

Medicine Ball

> **Material:** PVC

> **Joins:** Sticked

CODE	WEIGHT	DIAMETER	COLOR
44511	1,0Kg	16,0cm	Red
44512	2,0Kg	18,5cm	Red
44513	3,0Kg	21,3cm	Red
44514	4,0Kg	24,5cm	Red
44515	5,0Kg	—	Red

Panels
10

Category
E3

70262

Plyorebounder for
Medicine Balls



Weight
12.5 Kg

Category
F1

73×70×150cm

Slam Ball



- > **Material:** PVC 3mm
 - > **Filling:** Sand
- Improved production process, which ensures
- + Greater durability
 - + Waterproof
 - + Low price

CODE	WEIGHT	COLOR
90803	3,00 Kg	Black
90804	5,00 Kg	Black
90805	6,00 Kg	Black
90806	8,00 Kg	Black
90807	10,00 Kg	Black
90808	12,00 Kg	Black
90809	15,00 Kg	Black

Category
F1

Soft Grip Discs



- > **Shape:** Hexagon
- > **Material:** Nylon & Neoprene
- > **Filling:** Sand

Category
F1

CODE	WEIGHT
90751	2,0 Kg
90752	4,0 Kg
90753	6,0 Kg
90754	8,0 Kg
90755	10,0 Kg
90756	12,0 Kg

Wall Ball



- > **Material:** Heavy duty vinyl coated nylon, water and scuff resistant, soft-shell, double stitched, uniform weight
- > **Diameter:** 35cm

Category
F1

CODE	WEIGHT	COLOR
44689	3,00 Kg	Red
44690	4,00 Kg	Yellow
44691	5,00 Kg	Blue
44692	6,00 Kg	Green
44693	7,00 Kg	Dark Blue
44694	8,00 Kg	Pink
44695	9,00 Kg	Orange
44688	10,00 Kg	Grey

Wall Ball



Category
F1

- > **Material:** Rubber
- > **Diameter:** 35cm
- + **Usage:** On the wall, but also good durability when dropped/smashed
- + Great endurance
- + Soft texture
- + Excelent protection

CODE	WEIGHT	COLOR
84741	4,00 Kg	
84746	5,00 Kg	
84742	6,00 Kg	
84747	8,00 Kg	
84744	9,00 Kg	
84743	10,00 Kg	
84745	12,00 Kg	

Floss Wall Ball



Category
F1

- > **Material:** Rubber
- > **Weight:** ±50gr
- > **Filling:** Metal chips and/or sand, in order to have the same size with different weights
- + Precisely weighed, with a predictable course
- + Small diameter, easy to use and grip
- + Soft
- + Resistant to impact on the wall
- + For all these reasons, they are the best suited for use as a wall ball

> **The best 28cm wall balls available**

CODE	WEIGHT	COLOR
94623	3,00 Kg	
94624	4,00 Kg	
94625	5,00 Kg	
94626	6,00 Kg	

Wall Balls



Category
F1

> Cover: Kevlar

CODE		WEIGHT	COLOR
94611		5,00 Kg	
94612		6,00 Kg	
94613		8,00 Kg	
94614		10,00 Kg	

Wall Ball



Category
F1

> Material: PU
> Diameter: 34cm

CODE		WEIGHT	COLOR
94601	■	5,00 Kg	■
94602	■	8,00 Kg	■
94603	■	10,00 Kg	■

95150

- > **Discs:** 2 x 1.25kg
2 x 2.50kg
2 x 5.00kg
- > **Bar:** 1400x25mm hollow with rubber grip and spring collars
- > **Filling:** Cement with iron



25mm
Pump Set
Plasticized discs



Weight
17,5kg

Category
E1

44417

28mm
Pump Set
Bars

- > **Bar:** 1300x28mm hollow with **soft grip** (32-34mm) and spring collars, 1,50kg



28mm
Rubber Covered
Disks

- > **Material:** Rubber
- > **Ring:** Nylon
- > Suitable for Ø28mm bars
- > **Shape:** All disks are polygonal in shape, greatly aiding when handling them

CODE	WEIGHT	COLOR
44414	1,25 Kg	Yellow
44415	2,50 Kg	Blue
44416	5,00 Kg	Red

44418

- > **Bar:** 1300x28mm with **rubber grip** and spring collars, 2,25kg



Category
E1

44439

30mm
Pump Set
Bar

- > **Bar:** 1300x30mm hollow with **soft grip** and spring collars



30mm
Rubber Covered
Disks

- > **Material:** Rubber
- > **Ring:** Nylon
- > Suitable for Ø30mm bars
- > **Shape:** All disks are polygonal in shape, greatly aiding when handling them

CODE	WEIGHT	COLOR
84515	1,25 Kg	Red
84516	2,50 Kg	Yellow
84517	5,00 Kg	Green

Category
E1

Weighted Vest

84681

- > **Material:** Sweat-resistant cordura
- > **Weight:** Inside the pockets
- The large overlapping straps secure it tightly to the body
- Half of the weights (10kg) are placed on the front and half on the back



Weight 20Kg Category E1

84680

- > **Weights:** 10kg adjustable
- > **Packing:** Box
- > **Material:** Front: Nylon Back: Neoprene
- > **Weight:** Cilicone Jel
- + Supreme quality, absolute protection and comfort
- + Doesn't press or injure the shoulders
- + Compact and uniform performance when exercising
- + The best vest for running



Weighted Vest

Internal weights. Adjustable.



Std Pack 2 Category D10 W45xH43cm

84640

- > **Weights:** 10kg adjustable
- > **Packing:** Box
- Improved
- Soft weights
- Better fit
- Ideal for runners



Weighted Vest

Internal weights. Adjustable.

Category D10

44160

- > **Weights:** 0,5kg x 20 pcs removable
- > **Packing:** Box



Weighted Vest

Internal weights. Adjustable.

Std Pack 2 Category E1

W48xH44cm



95101

- > **Material:** Oxford 600D
- > **Length:** 38cm
- There are also 4 x 3cm sponge pads in the back combined with a breathable sandwich net, allowing the trainer to cushion the back, making it softer and more absorbent, relieving pressure on the back.
- Easily adjustable shoulder strap offers added comfort and better fit, while the joint also is reinforced.

Weight	Max-Weight	Category
1,65Kg	15Kg	E1

Military Vest



- Because of the novel design and then the steel plate's reinforcement, the vest is more stable on the body, does not fall off during exercising, it is firm and does not shake, ensuring safety and does not affect the center of gravity stability.



!!! Priced per item, sold per pair **Plates**

CODE	WEIGHT
95102	1,70 kg
95103	2,60 kg
95104	4,00 kg
95105	6,20 kg



Bottle Holder

CODE	COLOR
95351	Black
95352	Olive Green

- > **System:** Molle
- > **Material:** Nylon 1000D
- > **Dimensions:** Ø9 x 24cm
- > It can hold bottles from 0,5 up to 1,5lt



95350

Carabiner Clip

- > **Material:** ABS
- > **Dimensions:** 84x55x7,3mm



Patch with Velcro

CODE	PRINT	SIZE	LOGO
95343	"No pain no gain"	8x5,5cm	NO PAIN NO GAIN
95344	"Coach"	8x2,5cm	COACH
95345	"Athlete"	8x2,5cm	ATHLETE
95346	"AMILA tactical"	8x5,5cm	AMILA TACTICAL

Category F1

95347

AMILA TACTICAL 2.0 Backpack

- > **Capacity:** 45L
- > **Bag:** Polyester 600D with back PVC coating
- > **Mesh:** Air mesh 330g/m
- > **Strap:** Mesh Polyester 100%, 8cm wide
- > **Handle:** 5x2,5cm Polyester webbing
- > **Dimensions:** 33x29x46cm
- > **Pockets:** Each has 2 zipper pulls, one can open fully all the way down
- > **Compartments:** 2 main, 2 small in front and 1 at the back for a hydration bladder



Capacity 45lt Category F1

The pictured water bottle is not included 33x29x46cm

95348

AMILA TACTICAL 28lt

- > **Capacity:** 28L
- > **Bag:** Polyester 600D with back PVC coating
- > **Mesh:** Air mesh 330g/m
- > **Strap:** Mesh Polyester 100%, 8cm wide
- > **Handle:** 5x2,5cm Polyester webbing
- > **Dimensions:** 23x24x42cm
- > **Pockets:** Each has 2 zipper pulls, one can open fully all the way down
- > **Compartments:** 2 main, 2 small in front and 1 at the back for a hydration bladder



Capacity-28lt Category F1

The pictured water bottle is not included 23x24x42cm

95340

7lt TACTICAL Chest Bag

- > **Capacity:** 7L
- > **Material:** Polyester 600D with PVC coating
- > **Zipper:** YKK
- > **Compartments:** Large, small and front pocket with internal divisions
- > **Breathable** back material with mesh



Capacity 7lt Std Pack 20 Category F1

18x13x23,5cm

95349

Duffel Bag

- > **Capacity:** 35L
- > **Bag:** Polyester 600D with back PVC coating
- > **Dimensions:** 56x25x26cm
- > **Pockets:** Each has 2 zipper pulls, one can open fully all the way down
- > **Compartments:** Separate shoes compartment, another perforated compartment with elastic closure, internal pockets



Capacity-35lt Category F1

The pictured shoes are not included

56x25x26cm

48581

Agility Ladder

> Adjustable distance

Length 4m	Pegs 10	Std Pack 10	Category D10
--------------	------------	----------------	-----------------

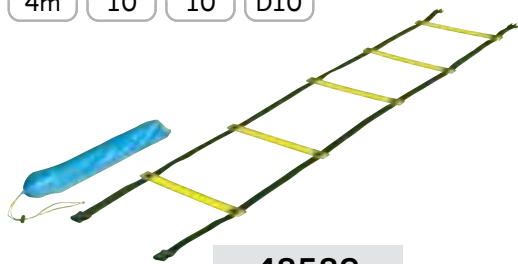

48589

> Adjustable distance

Length 9m	Pegs 21	Std Pack 6	Category D10
--------------	------------	---------------	-----------------

48586

- > Colors: Red, white, blue, yellow
- > Soft safe material



- > Cross section on the upper part in order to support Ø25mm poles

> Priced and Sold:
Per 40 pieces

PCS 40	Std Pack 12	Category D10
-----------	----------------	-----------------



Ø19×5cm

Soft PVC.
With holes to bolt to the ground.

Cones

44024

Height
38cm

44023

Height
31cm

44022

Height
23cm



Std Pack 50	Category D10
----------------	-----------------

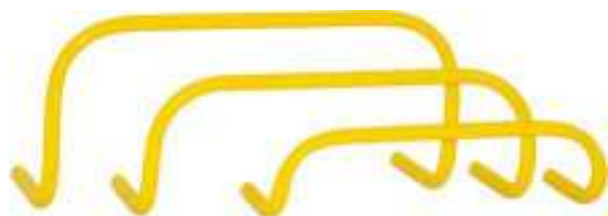

Hurdles

Automatic bounce back

CODE	HEIGHT	WIDTH
48604	20,00 cm	60,00 cm
48605	25,00 cm	60,00 cm
48606	30,00 cm	60,00 cm
48607	35,00 cm	60,00 cm
48608	40,00 cm	60,00 cm
48616	50,00 cm	60,00 cm
48617	60,00 cm	60,00 cm

- > **Automatic bounce back:** It returns back to its position when knocked down, thus eliminating time-breaks while doing drills.

Category
D10



Hurdles

CODE	HEIGHT	WIDTH
48588	41,00 cm	48,00 cm
48583	30,00 cm	48,00 cm
48587	23,00 cm	47,00 cm
48582	15,00 cm	46,00 cm

Material
PVC

Std Pack
20

Category
D10

48079

Power Fit Set

- + Very strong
- + Heavy duty
- + Absolutely stable



HEIGHT	PLATFORM	BASE
30,48 cm	33,02 cm	38,10 cm
45,72 cm	35,56 cm	45,72 cm
60,96 cm	38,10 cm	53,34 cm

Category
F1

93706

Semi-Commercial Grade

Height Adjustable Squat Box

- Non-slip checker plate top
- Built to take extremely heavy loads
- Easy pin and extra screw safety to adjust height in seconds.
- Great for performing box squats, high box squats, lunges, step ups, split squats, front squats, body weight extensions, one leg squats and more.



Category
F1

57×47×40cm

84559

84556

Plyometric Box with soft surface

> Heights: 51, 61, 76cm > Heights: 40, 50, 60cm

- + Soft surface, absolutely safe regarding injuries
- + 3 different heights
- + Absolutely stable



SCAN HERE  to view a sample video of exercises on our YouTube channel.

> **Material:** High-durability vinyl on the outside, wood and EVA on the inside



Strength 300Kg Category F1

Plyometric Boxes



+ Huge Velcro strips secure them safely one on top of the other

> **Shape:** Hexagon

+ The zipper allows the removal of the cover



> **Width:** 85cm from the middle of one side to the opposite one

CODE	HEIGHT
95132	30,00 cm
95133	45,00 cm
95134	60,00 cm

Category F1

95136

Plyometric Box

> Heights: 50, 60, 75cm
 > **Material:** Outer: Mat vinyl, Inner: Industrial type squeezed and PU foam

+ Fully assembled



Weight 16Kg Category F1

50x60x75cm

95131

Set of 4 Plyometric Boxes

> Heights: 15,3/30,5/45,7/61,0cm



- + Soft surface, absolutely safe
- + 4 boxes, each with a different height
- + Absolutely stable, connected with velcro
- + 1000D 0,65mm thick PVC cover over EVA with a hardness of ~30

Strength 200Kg Weight 50kg Category F2

76x91,5cm

84554

- > **Material:** Polyester
- > **Cover:** Nylon
- > **Diameter:** 38mm
- > **Grips:** Aluminum

Length 15m Category F1



Battle Rope

- + More comfortable, with a better feel on the handle
- + Does not come off
- + No fear of getting scratched
- + Increased durability

84553

Length 9m Category F1



8455 1

- > **Material:** Polyester
- > **Cover:** Nylon
- > **Diameter:** 38mm
- > **Grips:** PVC covered

Length 15m Category F1



Battle Rope



- > Built with DuPont™ Kevlar®
- > Improve your blood circulation

> **Diameter:** 38mm

- + High traction grip
- + Targeted pressure points
- + Angle supported
- + Enduring handles

Battle Rope



CODE	LENGTH
95111	9,00 m
95112	12,00 m

Diameter 38mm Category F1

Battle Rope

95308

- > **Material:** Manila
- > **Diameter:** 38mm



Climbing Rope



- > **Material:** Polyester
- > **Iva:** 2mm
- > **Sleeve:** Without
- > **Diameter:** 38mm
- > **Grips:** PE covered, long lasting

CODE	LENGTH
95113	9,00 m
95110	12,00 m
95114	15,00 m

Diameter 38mm Category F1

Length 7m Category F1

95311

AB Sling

- Heavy duty nylon supports
- Integrated padded elbow sleeve pockets
- Extra wide straps for the ultimate support
- Oversized D-ring connector to fit with any size bars in your gym
- Designed to minimize arm stress, helping to improve your technique



Category F1

83285

AB Sling

- > **Material:** Heavy-duty nylon
- > **Closure:** Velcro, easy to use
- + Cushions on the elbows for added comfort
- + Extra wide, for maximum support



Category F1



63x18,5cm

84552

ABS Gym Rings

- > **Handle:** ABS Ø2,8cm
- > **Strap:** 457x2,55cm



Category F1

84762

Wooden Gym Rings

- > **Handle:** Birch Ø3,2cm, smooth, diameter 23,5cm
- > **Strap:** 457x3,80cm



Category F1

43994

Parallette

- > **Material:** Steel tube, Ø38x2mm



Weight 6,68 Kg Strength 150Kg Category E6

70264

- > **Color:** Yellow



70267

- > **Color:** Black



SCAN HERE 
Promo video on our YouTube channel.

- > **Max user weight:** 100kg

Weight 6,72 Kg Strength 100Kg Category F1

Equalizer



61x41x70cm

84630

> **Packing:** Paper box



- > **Easy to install**
- > **Steel construction**
- > **Placement:** Wall
- > **Width at end of grips:** 132cm
- > **Distance from the wall:** Two options, 36cm and 56cm
- > **Grips:** Knurl
- > **Screws:** Includes screws with plastic expanding anchors
- > **Weight:** 11kg

Category
E6

Chin-up Rack

84628

> **Packing:** Paper box



- > **Easy to install**
- > **Steel construction**
- > **Placement:** Wall and ceiling
- > **Width at end of grips:** 111cm
- > **Distance from the wall:** 67cm
- > **Grips:** Knurl
- > **Screws:** Expansion screws included
- > **Weight:** 18kg

Category
E6

Chin-up Rack

84631

> **Packing:** Paper box



- > **Easy to install**
- > **Steel construction**
- > **Placement:** Wall and ceiling
- > **Width at end of grips:** 111cm
- > **Distance from the wall:** 60cm
- > **Grips:** Knurl
- > **Screws:** Expansion screws included
- > **Weight:** 13kg

Category
E6

Chin-up Rack

84632

> **Packing:** Paper box



- > **Easy to install**
- > **Steel construction**
- > **Placement:** Wall and ceiling
- > **Width at end of grips:** 116cm
- > **Distance from the wall:** 58cm
- > **Grips:** Rubber covered
- > **Βίδες:** Expansion screws included
- > **Weight:** 9kg

Category
E6

Chin-up Rack

Chin-up Rack

84629

> **Packing:** Paper box



- > **Easy to install**
- > **Steel construction**
- > **Placement:** Wall
- > **Width at end of grips:** 117cm
- > **Distance from the wall:** 38cm
- > **Grips:** Rubber covered
- > **Screws:** Expansion screws included
- > **Weight:** 4,5kg

Category E6

43995

> **Tubes:** Ø28x2mm
> **Packaging:** Box

- Trains shoulders, biceps, triceps, back and ABS
- Foldable for immediate and easy storage



AMiLA® Door Gym Multi

Multi-position door bar

Fe Steel Weight 4 Kg Std Pack 4 Category E6

44018



AMiLA® Horizontal bar

Chromed, with foam grip



Ø30, 630-930mm

Category E6

44007



AMiLA® Horizontal bar

Chromed, with foam grip



Ø30, 630-930mm

Category E6

Aerobic Bars



- > **Material:** Metal covered with NBR, smooth surface which is not easily damaged by friction
- > **Diameter:** Small difference between the two weights

Category D10

CODE	WEIGHT
95321	3,00 kg
95322	4,00 kg

- > **Material:** v foam
- > **Dimensions:** 125cm x Ø25mm

Aerobic Bars



Category D10

CODE	WEIGHT
44156	2,00 kg
44157	3,00 kg
44158	4,00 kg
44159	5,00 kg

43993

Perfect Push-up Rotating

- > **Material:** Plastic



PCS 2

Category E6

44009

Push-up Stand

- > **Material:** Plastic base, metallic body, foam covered grips



PCS 2

Std Pack 20

Category E6

44008

Push-up Stand

- > **Material:** Plastic base and body, foam covered grips



PCS 2

Std Pack 20

Category E6

44082

Exercise Wheel

- Extra-wide single wheel with ergonomic handles



18x30cm

Category F1

44072

Exercise Wheel

- > **Wheels:** 2 for increased stability
- > **Grips:** Foam



18x28cm

Weight 550gr Category F1

44074

Exercise Wheel

- > **Handle length:** 55cm
- > **Wheel diameter:** Ø37cm
- > **Wheel width:** 4cm



37x55cm

Category F1

Gliding Pads



CODE	COLOR
95951	Black
95952	Pink
95953	Grey

- > **Sides:** 2
- > **Material:** EVA (hard surfaces)
ABS (carpeted surfaces)

PCS 2 Diameter 18cm Category E6

44035

Chest Expander
With spirals

- > **Material:** Chrome
- > **Springs:** 5 metallic



Length 55cm PCS 1 Weight 1Kg Category E6

44003

Chest Expander

Made of rubber. Ideal for women and kids.

- > **Material:** TPR



Length 1m Std Pack 12 Category D10

44204

AB Roller

The best instrument for people with waist problems, who need to perform exercises painlessly and efficiently

- > **Tube:** Ø25x1.2mm
- > **Packaging:** Box
- > Reinforced frame

Std Pack 5 Category D7



74x68x70cm

95890

Revo Ball

> Grip: Anodized aluminium

Handgrips



Category E6

PCS 1 Std Pack 50 Category E6

CODE		SPRING	RESISTANCE
44086		5,5mm	100lbs / 45kg
44087		6,0mm	150lbs / 60kg
44088		6,5mm	200lbs / 90kg
44089		7,0mm	250lbs / 115kg

44001

Handgrips

Soft grips.

> Spring: 5,5mm, a lot stronger than the others

> Material: Neoprene covered grips



44033

> Spring: 4,5mm



PCS 2 Std Pack 48 Category E6

44076

> Resistance: Adjustable 10-40kg

PCS 1 Std Pack 50 Category E6



The resistance is easily adjusted with the turn of a knob

44080

Handgrips

Adjustable

> Grip: Very robust, made of PP/TPR
 > Spring and internal mechanism: Made of steel
 > Resistance: Adjustable 10-40kg

PCS 1 Category E6



IMPROVED PRODUCT

84578

POWER SLIM

Speed Rope

- > **Grips:** Aluminum, 14cm length, Ø1,8cm diameter
- > **Length:** 3,00m
- > **Cable:** Ø2,6mm

- With highest quality bearings
- Excellent speed
- Adjustable length, the cable is stored inside the handle

Self-locking structure, no need to use a screwdriver to adjust the length



Category F1

84579

POWER GRIP

Speed Rope

- > **Grips:** Plastic, covered with sweatbands, 13cm length, Ø1,8cm diameter
- > **Length:** 3,00m
- > **Cable:** Ø2,6mm

- With highest quality bearings
- Excellent speed
- Adjustable length, the cable is stored inside the handle

Self-locking structure, no need to use a screwdriver to adjust the length



Category F1

44057

Jump Rope with Weights

With weights in the grips

- > **Grips:** Wrapped with sweatband
- > **Length:** 3,30m
- > **Cable:** Ø3,0mm

- > **Length:** 3,30m adjustable



- > **Bearings:** Type 608



- Removable weights, 130gr per grip

Category E6

44051

Speed Rope

ALUMINIUM

- > **Grips:** Aluminium
- > **Length:** 3,35m
- > **Cable:** Ø2,5mm

- > **Length:** 3,35m adjustable



Category E6

84575

- > Length: 3,00m
- > Cable: Ø2,5mm

- Friction metal-on-metal (metal sphere inside the metal head), long service life
- Adjustable length, the cable is stored inside the handle
- Removable weights, 40gr per grip

Category
F1



> The cable is stored inside the handle

Speed Rope



> The cap of the grips is used as a screwdriver to adjust the length of the cable

84576

- > Length: 3,00m
- > Cable: Ø2,5mm

- Friction metal-on-metal (metal sphere inside the metal head), long service life
- Adjustable length, the cable is stored inside the handle

Category
F1



> Friction metal-on-metal (metal sphere inside the metal head), long service life



Speed Rope



84577

- > Length: 3,00m
- > Cable: Ø2,4mm

- Without bearings
- Metallic bushing
- Excellent speed
- Shorter service life

Category
F1



Speed Rope

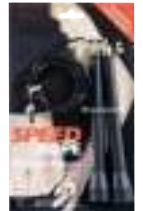

84580

- > Grips: Plastic, 11,7cm length, Ø1,5cm diameter
- > Length: 3,00m
- > Cable: Ø2,6mm

- With good quality bearings
- Length adjustable with screws
- Adequate speed
- Adjustable length, the cable is stored inside the handle

Category
F1



Speed Rope



44055

Jump Rope

With bearings and weights
LEATHER,
suitable for boxers

- > Length: 2,75m
- > Cord: Leather
- > Weights: 2 x 120g



Size 24cm Category E6

44069

Jump Rope

With bearings
LEATHER

- > Cord: Leather
- > Grips: Wooden



Size 24cm Category E6

44070

Jump Rope with Weights

- > Grips: Plastic
- > Packaging: Blister



Size 24cm Category E6

44064

Jump Rope with Counter



Std Pack 48 Category E6

84558

Speed Rope

- > Length: 3,00m
- > Cable: Ø2,4mm
- > Packaging: Blister



- With bearings



Category F1

44053

Jump Rope with Weights

- > Dimension: 275cm
- > Grips: Soft
- > Weights: 2 x 120g
- > Packaging: Blister



Std Pack 48 Category E6

44059

Jump Rope

With bearings

- > Dimensions: 0,52x275cm
- > Cable: Synthetic
- > Grips: Soft



Std Pack 48 Category E6

44060

Jump Rope

- > Dimensions: 0,52x275cm
- > Cable: Synthetic
- > Grips: Wooden



Std Pack 48 Category E6

94902

> **Waist:** 77-95 cm



94903

> **Waist:** 87-105 cm



Leather Weight Lifting Belt

With pillow

- > **Material:** Genuine **Grade A** leather
- > **Width:** 10cm



833 1002

> **Waist:** 80-98 cm



833 1003

> **Waist:** 84-104 cm



833 1004

> **Waist:** 93-112 cm



Leather Weight Lifting Belt

With pillow

- > **Material:** Genuine **Grade A** leather
- > **Width:** 10cm
- > **Lining:** Suede



44301

> **Waist:** 77-96 ccm



44302

> **Waist:** 82-101



Leather Weight Lifting Belt

With pillow

- > **Material:** Genuine **Grade A** leather
- > **Width:** 10cm
- > **Lining:** Suede



94920

> **Waist:** 62-83cm



94921

> **Waist:** 70-90cm

94922

> **Waist:** 85-104cm

94923

> **Waist:** 89-111cm



Leather Weight Lifting Belt

With pillow

- > **Material:** Genuine **Grade B** leather
- > **Width:** 15cm
- > **Lining:** Suede



94906

> Waist: 67-84 cm

94907

> Waist: 77-95 cm

94908

> Waist: 85-103 cm

94909

> Waist: 98-115 cm

Leather Weight Lifting Belt

With pillow

- > Material: Genuine **Grade B'** leather
- > Width: 10cm



94915

> Length: 96 cm
> Buckle: BLACK

94916

> Length: 105 cm
> Buckle: BLACK

94917

> Length: 110 cm
> Buckle: BLACK

94918

> Length: 115 cm
> Buckle: SILVER

Leather Power Lifting Belt

- > Material: Genuine **Grade C'** leather
- > Width: 10cm
- > Lining: Suede



83336

> Waist: 76-94cm

83337

> Waist: 80-98cm

83338

> Waist: 84-103cm

83339

> Waist: 90-108cm

Leather Weight Lifting Belt

With pillow

- > Material: Genuine **Grade C'** leather
- > Width: 10cm
- > Lining: Suede



44305

> Waist: 78-96 cm

44306

> Waist: 83-102 cm

44307

> Waist: 88-106 cm

44308

> Waist: 95-113 cm

Leather Weight Lifting Belt

With pillow

- > Material: **Grade B'** split leather
- > Width: 10cm
- > Lining: Suede



94911

> **Waist:** 67-85 cm

94912

> **Waist:** 77-95 cm

94913

> **Waist:** 85-103 cm

94914

> **Waist:** 98-115 cm

Leather Weight Lifting Belt

With pillow

- > **Material:** Genuine **Grade C** leather
- > **Width:** 10cm



44326

> **Waist:** 79-93 cm

44327

> **Waist:** 87-101 cm

44328

> **Waist:** 98-110 cm

44329

> **Waist:** 110-120 cm

Weight Lifting Belt

The best belt with the ultimate protection

- + Special reinforcements fully support the area of the waist, protecting from injuries

> **Width:** 20cm



83332

> **Waist:** 77-92 cm

83333

> **Waist:** 89-103 cm

83334

> **Waist:** 97-111 cm

83335

> **Waist:** 100-117 cm

Predator

With pillow

- > **Material:** Neoprene
- > **Width:** 15 cm



44330

> **Waist:** 72-87 cm

44331

> **Waist:** 79-94 cm

44332

> **Waist:** 86-100 cm

44333

> **Waist:** 91-108 cm

Weight Lifting Belt

Velcro closure.

- > **Material:** Neoprene
- > **Width:** 13 cm



83280

Head Harness

- > **Material:** Nylon with Neoprene padding
- > **Chain:** 71cm
- > **Size:** One size
- Suitable for **heads** with a perimeter of 56-63cm



Category E3

94901

Dip Belt

- > **Material:** Neoprene
- > **Chain:** 71cm
- > **Size:** One size, adjusted by steel hook



13mm thick

Category E3

84x15,5cm

94900

Dip Belt

- > **Material:** Neoprene
- > **Chain:** 71cm
- > **Size:** One size, adjusted by steel hook



8mm thick

Category E3

84x15,5cm

44340

44341

44342

44343

> **Waist:** 80-87 cm

> **Waist:** 90-98 cm

> **Waist:** 100-109 cm

> **Waist:** 110-118 cm



Category E3

Curved Weight Lifting Aerobic Belt

Anatomic Aerobic Belt. Velcro closure.

- > **Material:** Neoprene
- > **Width:** 14 cm

44335

44336

44337

44338

44339

> **Waist:** 66-78 cm

> **Waist:** 76-90 cm

> **Waist:** 86-101 cm

> **Waist:** 97-113 cm

> **Waist:** 107-122 cm



Category E3

Straight Weight Lifting Aerobic Belt

Straight Aerobic Belt. Velcro closure.

- > **Material:** Lycra + Neoprene
- > **Width:** 11 cm

- > **Material:** Nylon mesh with neoprene cushions
- > **Closure:** Velcro, easy to use

- + Very comfortable
- + High durability

- Can replace traditional gloves

Palm Grips



CODE	SIZE
83288	S/M
83289	L/XL

Category F1

- The silicone pads in the palm provide great grip, extreme comfort and complete protection
- Ventilation is ensured by the large openings, while the velcro closure, with neoprene padding, provides firm grip on the wrist while at the same time offers great comfort

Palm Support Gloves



CODE	SIZE
8328401	S
8328402	M
8328403	L
8328404	XL
8328405	XXL

Category F1

83297

Power Straps

- 52cm long strap made of heavy duty cotton and grip flex rubber, gel padded wrist support 6mm, both 4cm wide



Category E3

83296

Power Straps

- 31cm long nylon strap with acrylic webbing for optimum grip and durability, neoprene padded wrist support 6mm thick and 6cm wide
- The strap is triple stitched perpendicular to the wrist support for secure and precise wrap around the bar
- Rugged stainless steel buckle



Category E3

> **Material:** Thick, tri-color fabric, elastic, great durability

- Necessary when lifting heavy weights
- + Reinforces and stabilizes the wrist, reducing the risk of accidents

Wrist Wraps



Category E3

CODE	LENGTH
83282	30,00 cm
83283	45,00 cm

83294

Power Straps

> **Material:** Cotton with padding
> **Packing:** Polybag

- Anti-slip surface for a secure grip



Category E3

83293

Lat Hooks

> **Material:** Steel hooks with Neoprene strap



Category E3

83281

Lat Hooks

- Rubber covered metal hooks
- Cotton straps with velcro closure
- Neoprene cushions

- + Secure grip
- + Very comfortable
- + Highly durable



Category E3

83298

Lat Hooks

- The metallic lat hooks are used for strengthening the grip when performing heavy tensile exercises and exercises of abdominal muscles in hanging position on horizontal bar
- Customized fit around the wrist with adjustable velcro closure



Category E3

83295

Lat Hooks

- Wrist band 6mm thick, 6cm wide, neoprene padded wrist support
- Coated durable metal hooks for a secure grip
- Great for lat pull downs, shrugs, pull ups, low rows and others back and shoulder exercises



Category E3

- > **Palm:** Durable, weather resistant, soft and comfortable Amara leather with PU and ergo gel padding for extreme comfort and energy absorption
- > **Back:** Spandex for high flexibility, breathability and better fitting, with added rubber panels for maximum protection
- > **Closure:** Velcro with Neoprene wrist wrap

Weight Lifting Gloves



CODE		SIZE
8330501		S
8330502		M
8330503		L
8330504		XL
8330505		XXL



- > **Palm:** Durable leather for natural grip and ergo gel padding for extreme comfort and energy absorption
- > **Back:** Spandex for high flexibility, breathability and better fitting
- > **Closure:** Velcro with Neoprene wrist wrap, double-stitched for enhanced durability

Weight Lifting Gloves



CODE		SIZE
8330401		S
8330402		M
8330403		L
8330404		XL
8330405		XXL



- > **Palm:** Durable leather for natural grip and ergo gel padding for extreme comfort and energy absorption
- > **Back:** Spandex for high flexibility, breathability and better fitting
- > **Closure:** Velcro with Neoprene wrist wrap, double-stitched for enhanced durability
- > **Fingers:** Pull-off-tabs for easy removal

Weight Lifting Gloves



CODE		SIZE
8330205		XXL



- > **Palm:** Durable, weather resistant, soft and comfortable Amara leather with PU, ergo gel padding for extreme comfort and energy absorption and terry towel on thumb to wipe off sweat
- > **Back:** Lycra for high flexibility, breathability, internal airflow, quick dry and better fitting
- > **Closure:** Velcro
- > **Fingers:** Pull-off-tabs for easy removal and added elastic for better fitting and irritation avoidance

Weight Lifting Gloves



CODE		SIZE
8330601		S
8330602		M
8330603		L
8330604		XL



- > **Palm:** Durable, weather resistant, soft and comfortable Amara leather with PU, ergo gel padding for extreme comfort and energy absorption, and air mesh for maximum breathability
- > **Back:** Lycra for high flexibility, breathability and better fitting
- > **Closure:** Velcro
- > **Fingers:** Pull-off-tabs for easy removal and added elastic for better fitting and irritation avoidance

Weight Lifting Gloves



CODE	SIZE
8330101	S
8330102	M
8330103	L
8330104	XL
8330105	XXL



- > **Palm:** Durable, weather resistant, soft and comfortable Amara leather with anti-slip silicone prints, upholstery and minimized foam pads for complete freedom of movement and optimal cushioning
- > **Back:** Lycra for high flexibility, breathability, internal airflow, quick dry and better fitting
- > **Closure:** Velcro
- > **Fingers:** Pull-off-tabs for easy removal and added elastic for better fitting and irritation avoidance

Weight Lifting Gloves



CODE	SIZE
8330301	S
8330302	M
8330303	L
8330304	XL
8330305	XXL



- > **Palm:** Polyester fabric with slip-resistant PVC dots, upholstery and minimized foam pads for complete freedom of movement and optimal cushioning
- > **Back:** Lycra for high flexibility, breathability, internal airflow, quick dry and better fitting
- > **Closure:** Velcro
- > **Fingers:** Pull-off-tabs for easy removal and added elastic for better fitting and irritation avoidance

Weight Lifting Gloves



CODE	SIZE
8330901	S
8330902	M
8330903	L
8330904	XL



- > **Palm:** Polyester fabric with slip-resistant PVC dots, upholstery and minimized foam pads for complete freedom of movement and optimal cushioning
- > **Back:** Lycra for high flexibility, breathability, internal airflow, quick dry and better fitting
- > **Closure:** Velcro
- > **Fingers:** Pull-off-tabs for easy removal and added elastic for better fitting and irritation avoidance

Weight Lifting Gloves



CODE	SIZE
8330801	S
8330802	M
8330803	L
8330804	XL
8330805	XXL



70261

Semi-Commercial
Grade

Trampoline 115

- > **Dimensions:** Ø115x22,5 cm
- > **Frame:** Ø25x1,2mm
- > **Feet:** Ø25x1,8mm
- > **Cover:** 0.30mm PVC
- > **Filling:** 15mm Foam
- > **Springs:** 3mm
- > **Max user weight:** 80Kg

For Personal Training

Std Pack
1Category
D7

70260

Semi-Commercial
Grade

Trampoline 97

- > **Dimensions:** Ø97x22,5 cm
- > **Frame:** Ø25x1,2mm
- > **Feet:** Ø25x1,8mm
- > **Cover:** 0.30mm PVC
- > **Filling:** 15mm Foam
- > **Springs:** 3mm
- > **Max user weight:** 80Kg

For Personal Training

Std Pack
1Category
D7

Τραμπολίνο

Tips & Tricks για γερά πόδια

Τα πόδια των προϊόντων **70260** και **70261** είναι βιδωτά στο πλαίσιο που στερεώνονται τα ελατήρια.

Λόγο των ανοχών που υπάρχουν έχει παρατηρηθεί πως η συχνή χρήση του τραμπολίνο δημιουργεί αναπόφευκτες φθορές στα σπειρώματα με αποτέλεσμα η δυνατότητα συγκράτησης τους σταδιακά να ελαττώνεται.

Για τη μέγιστη δυνατή αποφυγή ανάλογων συνεπειών προτείνουμε δυο διαφορετικές λύσεις που συνηθίζεται να χρησιμοποιούνται στις συναρμογές:

Ταινία Τεφλόν κ Υποκατάστατα

Η χρήση της ταινίας τεφλόν στα σπειρώματα είναι η πιο διαδεδομένη λύση **απαλοιφής των ανοχών** και στεγανοποίησης. Εκτός από την ταινία τεφλόν, στο εμπόριο υπάρχουν πλέον πολλά **υποκατάστατα** προϊόντα (**στεγανοποιητικό νήμα, υγρό τεφλόν κ.α.**) που κάνουν την εφαρμογή τους για την επίτευξη του επιθυμητού αποτελέσματος πραγματικό παιχνίδι.



Tip *

Το μυστικό βρίσκεται στη **σύσφιξη**. Με την εφαρμογή της κόλλας σπειρωμάτων πρέπει να σφίξουμε μέχρι να πατήσει η βίδα χωρίς δύναμη και μετά να σφίξουμε κατά 30 μόιρες μόνο. Τα υπόλοιπα τα αναλαμβάνει η κόλλα, ανάλογα με τις ιδιότητες που έχει.

Η **κόλλα (ή ασφαλιστικό) σπειρωμάτων** είναι ειδικής σύνθεσης υλικό που γεμίζει τα κενά ανάμεσα στο σπείρωμα και στο πάσο.

Στερεοποιούνται με την πλήρη απουσία αέρα ή την επαφή με το μέταλλο με την μορφή σκληρού θερμικού πλαστικού. Παράλληλα δε αυξάνουν κατά πολύ την τριβή μεταξύ των μερών που εφάπτονται δημιουργώντας ένα λεπτό στρώμα εξαναγκάζοντας τα συγκολλημένα μέρη να παραμένουν σταθερά.

Για την μέγιστη απόδοση τα μέρη που θα γίνει η εφαρμογή θα πρέπει να είναι απόλυτα καθαρά από λάδια, γράσα κ.λπ.

Κόλλα Σπειρωμάτων



Τα είδη της Κόλλας Σπειρωμάτων

- **Χαμηλής Αντοχής** (συνήθως μπλε χρώματος): Εύκολη αποσυναρμολόγηση με εργαλεία χειρός.
- **Μεσαίας Αντοχής** (συνήθως κόκκινου χρώματος): Πιθανή αποσυναρμολόγηση με εργαλεία χειρός.
- **Μεγάλης Αντοχής** (συνήθως πράσινου χρώματος): Δύσκολη έως απίθανη αποσυναρμολόγηση με εργαλεία χειρός. Προϋπόθεση χρήσης εργαλείων θέρμανσης θερμοκρασία (>250°C). Αποσυναρμολογήστε και καθαρίστε όσο είναι ακόμα ζεστό.

70263

FULL Commercial Grade

- > Height from ground: 32,5cm
- > Frame: Ø28,6x1,8mm
- > Legs: 25,4x1,5x560mm
- > Grip: Ø25,4x1,5x560mm
- > Lower support tube: Ø30x30x1,8x500mm
- > Upper support tube: Ø25x25x1,5x1000mm
- > Cords: 36 pcs
- > Mat: PP
- > Max user weight: 130Kg
- > Dimensions: 111,5 x 124 cm x 117~151cm
- > Packaging: Carton



70268

!!! Also available in pink color



Hexagon Trampoline
With handlebar

MAXIMUM
user weight
130Kg

- Heavy duty
- Suitable for gyms

70269

Frame/Cord Pad

Cover and protect the cords for your own safety and the trampoline's longevity



Weight
13,6kg

Std Pack
1

Category
F1



44043

> Dimensions:
90x40x18,5cm

COMMERCIAL

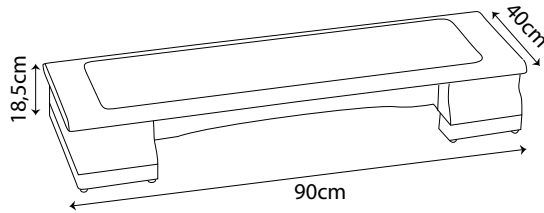

- > Anti-slip surface
- > **Material:** Extremely durable plastic
- > **Height:** 13,5 & 18.5 cm

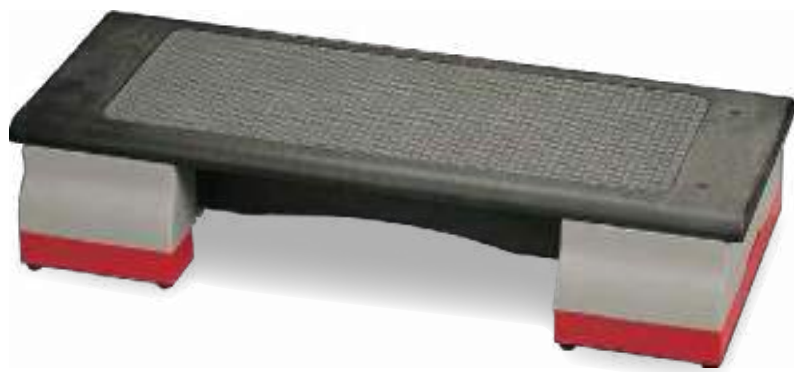

Positions 2
Category D10

44077

> Dimensions:
69x40x22cm

COMMERCIAL

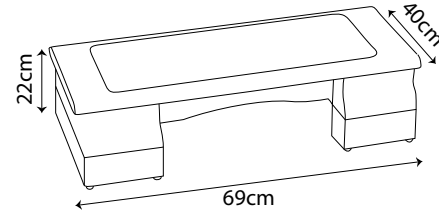

Aerobic Step

- > Anti-slip surface
- > **Material:** Extremely durable plastic
- > **Height:** 13, 18 & 22 cm



44027

- > Stable
- > Anti-slip surface
- > Ideal size
- > **Height:** 10, 15 & 20 cm
- > **Material:** Plastic

AMILA Step

For personal use, without a personal trainer.



Positions 3
Std Pack 4
Weight 3,5Kg
Category D10

78x29cm

44038

- > **Height:** 10 & 15 εκ.
- > **Material:** Plastic

AMILA Step

For personal use, without a personal trainer.



Positions 2
Std Pack 4
Category D10

67x27cm

44039

- > **Dimensions:**
Body: 108x43x10,5cm
Feet: Ø43x9,5cm
- > **Height:** 10,5 & 16cm



> Rubber feet to protect the floor



Two ways to join the feet with the body:
a) Locked, absolutely stable, some difficulty when joining/separating.
b) Without lock, easy to change height, requires some care when transporting.

b) Without lock, easy to change height, requires some care when transporting.

Weight 9,0kg Category F1

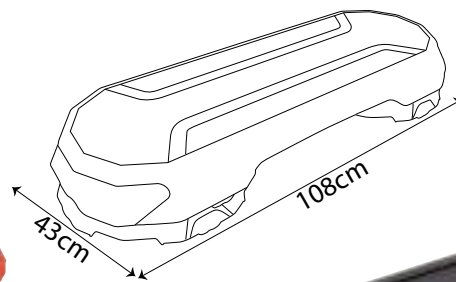

Monster Step

Greater stability due the unique shape of the feet

> Each foot can be used as a standalone step

> Reinforced construction

108x43cm

44040

- > Anti-slip surface
- > **Height:** 15,5, 20,5 & 25 cm

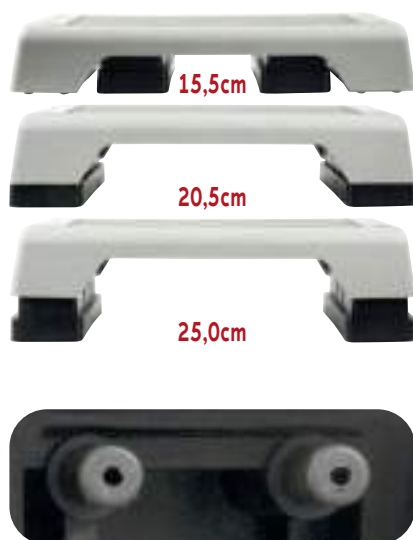

> Rubber feet to protect to floor

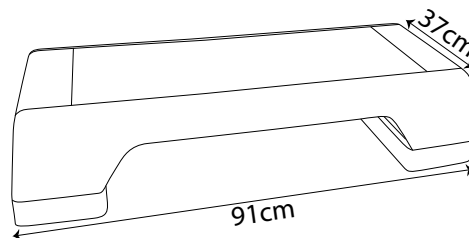

> Rubber anti-slip surface 68x26,5cm

> Reinforced construction

91x37cm

Aerobic Step

Positions 3 Weight 6,9kg Category D10

96051

Air Cushion

> **Material:** Without PVC



Category D10

Ø35cm

48231

Balance Cushion

• Without Latex, PVC, Phthalates and Chlorides



Category D10

Ø36cm

95882

Balance Cushion with Handle



Weight 1.0kg

Category D10

Ø33cm

48035

Balance Plate

Very good for the medium-level, but also for the demanding user. Weight of user up to 90kg.



Weight 6.3kg

Std Pack 6

Category D10

Ø39.5x8cm

48048

Balance Plate

Suitable for beginners and up to 80kg users. Fairly easy to use. A "pillow of air" helps the novice users, but does not allow it to be used by heavy persons. Exercises ankles, especially in recovery/rehabilitation situations.



Category D10

Ø40x8cm

48049

Balance Plate

Very demanding (on the 2nd level), for experienced fit users. Weight of user up to 100kg.

> 2 levels of difficulty

> **Material:** P1P



1st difficulty level

2nd difficulty level

Category D10

Ø42x58cm

81793

Circle Wobble Board

For aerobics use

- > **Material:** Disc: HDPE/LDPE
Base: TPE/EVA
- > **Base:** Soft
- > **Dimensions:**
Disc: Ø38,5x2cm
Base: Ø23/20x12cm



Std Pack 6
Category D10

Ø38×14cm

81796

Rectangular Balance Board

For aerobics use

- > **Material:** Disc: Plywood
Base: TPE
- > **Base:** Medium hardness
- > **Dimensions:**
Disc: 60x39x2cm
Feet: Ø12,5x9cm



Std Pack 6
Category D10

60×39×11cm

> **Material:** Foam

Balance Pad

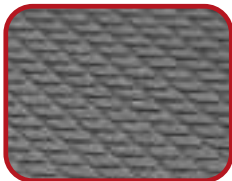

Category D10

40×50×6cm

CODE		COLOR
81765		Blue
48195		Black

48045

Stepping Stones

> **Dimensions:** 18cm



+ Inflation valve on the bottom



Std Pack 24
Category D10

96052

Hemorrhoids Cushion

Cushion for people suffering from hemorrhoids

- > **Material:** Without PVC, Latex, phthalates and chlorids, non-toxic, non-allergic, recyclable and soft
- > **Sides:** 2 different ones



Category D10

360×340×68,5mm

AMILA® BALANCE BALLS

Balance Balls are widely used in fitness, sports and rehabilitation, offering cardio, muscle strengthening, flexibility and endurance exercises. It will become your ally in improving your balance and posture.

High Quality

The base of the Ballance Balls is made of high quality plastic (PP), whereas the top part is made from PVC, offering maximum durability.

Anti-slip surface

The top part of the Ballance Balls has an anti-slip surface, due to their unique design.



95880

Balance Ball



SPECIFICATIONS

Dimensions: 60,0x60,0x23,0 cm

Endurance: 150 Kg

NET weight: 4,5 kg

Category: D10

95875

Balance Ball

Anti-slip 3mm high quality PVC

Anti-slip (PP) base



Tubes and pump included

SPECIFICATIONS

Dimensions: 60,0x60,0x23,0 cm

Endurance: 140 Kg

NET weight: 5,2 kg

Category: D10

CODE	PRICE	COLOR
48192		
48193		

Balance Ball

Anti-slip high quality PVC

Marine plywood base



Tubes and pump included

SPECIFICATIONS

Dimensions: 69,0x69,0x25,0 cm

Endurance: 300 Kg

NET weight: 7,3 kg

Category: D10

48197

Balance Ball

Anti-slip 4mm high quality PVC

Anti-slip (PP + TPE) base



Pump included

SPECIFICATIONS

Dimensions: 61,5x61,5x20,0 cm

Endurance: 200 Kg

NET weight: 6,9 kg

Category: D10

AMILA®

You Tube

Discover all of the **AMILA GymBall** exercises on our YouTube channel by scanning with your mobile the following qr-code.



DIAMETER	WEIGHT	COLOR	PACKAGING BOX WITH PUMP		PACKAGING BULK (NYLON BAG)	
			CODE	PRICE	CODE	PRICE
Ø45cm	0,75Kg				48086	
					48085	
Ø55cm	1,00Kg		95826		48412	
			95827		48438	
			95828		48440	
			95829		48410	
			95830			
						48437
Ø65cm	1,35Kg		95845		48414	
					48439	
			95846		48441	
Ø75cm	1,70Kg		95847		48413	
			95865		48417	
			95866		48443	
					48415	
			95867		48425	

AMILA®
GYM BALL
 EXERCISE BALL
ANTI BURST

GymBall

- > **Material:** USA PVC (Higher Quality)
- > **Endurance:** 300Kg



AMILA GymBalls are constructed from USA PVC, a **high quality** and **very sturdy** material, which **offers excellent grip**, so that you are always in full control of your exercises.



What is included in the box:

- Dual-action pump by AMILA
- Replacement plug for the air valve
- Sample exercises by Ifigenia Baka and Panagiotis Katsaounos, with video links of the recommended exercises



The **AMILA TwoTone GymBall** with reinforced base is one of the most flexible gym equipment. It offers a large variety of exercises for strengthening the upper part of the body, improving posture and flexibility.

The weight increases on the area of the double layer (dark colouring), forcing the ball to stabilise on it, continually using it as a base.

The reinforced lower side offers extra **grip** and prevents the rolling of the ball.

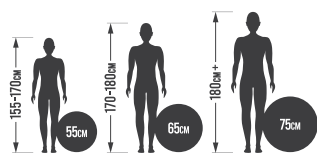

CHOOSE THE CORRECT SIZE

Gym balls are made in various sizes, using diverse materials. Using the right size for your body is essential for achieving the optimal results from your training.

You may derive the correct diameter for your body by sitting on the ball and your knees are at a 90 degree angle.

Tip: Your height is not the only factor for choosing a Gym Ball. The balls are flexible, so your weight is also quite important.

- > **Material:** PVC with reinforced base
- > **Endurance:** 300Kg
- > **Packaging:** Nylon bag

DIAMETER	WEIGHT	COLOR	CODE	
Ø65cm	1100gr		48445	
			48446	

Two Tone Gym Balls

Returns to upright position



Category D10



- > **Material:** Felt
- > **Packaging:** Nylon bag

DIAMETER	CODE	
Ø65cm	95886	
Ø75cm	95887	

Felt Cloth Ball Cover

Cover for Gym Balls

Inverted seams and felt material for a **non-slip feel, safety and comfort** during use.

Premium GymBall cover, complete with grip to easily transport and a zipper to remove from the ball and be able to wash it.



Category D10

Peanut Ball

ΣΥΣΚΕΥΑΣΙΑ ΣΑΚΟΥΛΑ (BULK)					
DIAMETER	LENGTH	WEIGHT	COLOR	CODE	
Ø45cm	85cm	1,40Kg		48095	
				48087	



Smart Exercising with a Game

The **AMILA Peanut Ball** has a wide range of benefits and can be a **fun** and very **engaging** way to cleverly introduce a game based therapy into the child's everyday life.

Peanut Shaped Gym Balls

- They only move in one direction, providing greater stability and control.
- They offer greater support to the spine and protect against minor injuries.
- They are ideal for rehabilitation and treatment, both for children and adults.

Peanut Balls are the tool of choice by thousands of physical therapists around the world.

They enhance the user's **balance** skills and ability to **focus**. It is excellent for **games and exercises** aimed at **tactile stimulation**.

Get the kids to use them at home instead of a regular chair, during homework or while watching TV.



Pregnancy Aid

The **AMILA Peanut Ball** is an important birthing aid (opening the pelvis) or epidural aid for use between the legs while resting on the bed.

However, the **unique advantages of a stable and controlled direction** make it ideal for practicing throughout pregnancy.



Scan the code and discover the first ever exercises for pregnant women by Ioanna Vaporidi (MSc Physical Education) and aquabirth.gr

Std Pack 8 Category D10

48071

- > **Diameter:** Ø50cm
- > **Material:** Vinyl
- > **Packaging:** Nylon bag

Jumping Ball with Handles

With two handles.
For fun and people with movement disabilities.



Std Pack 25 Category D10

99350

- > **Diameter:** Ø45cm
- > **Material:** Vinyl
- > **Packaging:** Nylon bag

Jumping Ball with Handle

With "D" shaped handle.
For fun and people with movement disabilities.



Std Pack 8 Category D10

AMILA®

AMILA® PILATES BALL



AMILA GymBalls are constructed from USA PVC, a **high quality** και **very sturdy** material, which **offers excellent grip**, so that you are allways in full control of your exercises.



◀ The box includes an exercise book by Ifigenia Baka, with video links of the exercises she recommends.

PilatesBall

> **Material:** USA PVC (Higher Quality)
> **Endurance:** 150Kg

Category D10



> **Material:** USA PVC (Higher Quality)
> **Endurance:** 150Kg

Category D10



DIAMETER	WEIGHT	COLOR	PACKAGING BOX		PACKAGING BULK (NYLON BAG)	
			CODE		CODE	
Ø19cm	150gr		95801		95804	
			95803		95806	
					48430	
					48433	
			95802		95805	
			48400		48432	

DIAMETER	WEIGHT	COLOR	PACKAGING BOX		PACKAGING BULK (NYLON BAG)	
			CODE		CODE	
Ø25cm	180gr		95815		95818	
			95817		95820	
					48431	
			48401			
			95816		95819	
					48435	

The AMILA Pilates Ring activates and stimulates the muscular system in the torso, offering toning and strengthening of the muscles that form the core of the body (abdominal, back, buttocks). It also improves posture, flexibility and spinal stability.



Pilates Ring 14"



CODE	HARDNESS	COLOR
88154	Soft	
88153	Medium	
88152	Hard	

Diameter 35,5cm Weight 0,8kg Std Pack 10 Category D10

48082

Pilates Ring

> Material: Fiberglass/ABS/PVC



• Personal use



Diameter 36cm Weight 0,7kg Std Pack 10 Category D10

81792

> Material: ABS inner, TPE outer

- + Soft and non-slip outer surface due to TPE
- + Extremely durable inner due to ABS



• In two colors

Yoga Wheel



Ø33cm

Category D10

> Material: PVC
> Filling: Sand
> Packaging: Polybag

Gym Ball
Does not bounce



CODE	WEIGHT	DIAMETER	COLOR
84701	1kg	Ø11cm	
84708	2kg	Ø13cm	
84709	3kg	Ø14cm	
84710	4kg	Ø16cm	

Category D10

> Material: Soft plastic
> Packing: Polybag

Massage Balls

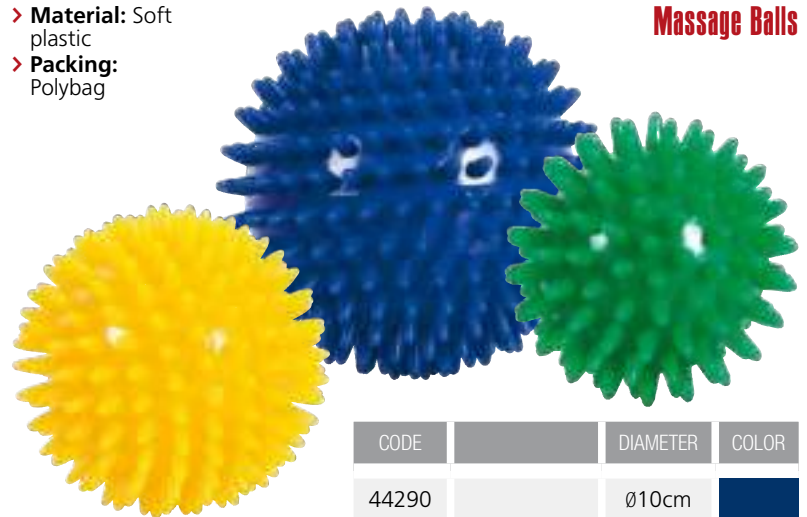

CODE	DIAMETER	COLOR
44290	Ø10cm	
48233	Ø8cm	
48234	Ø7cm	

Category D10

48090

- > **Material:** EVA
- > **Packaging:** Polybag

+ **Soft:** For beginners and those with trigger points they want to relax

This pistachio-shaped massage ball by AMILA is ergonomically designed to target all muscles which are difficult to reach with Foam Rollers, in order to help reduce the feeling of pain and provide faster muscle recovery.

Peanut Shaped Massage Ball



Weight 250gr Category D10

Ø8×16cm

96815

- > **Material:** EVA
- > **Packaging:** Polybag

Massage Ball



Weight 200gr Category D10

Ø12cm

48091

- > **Material:** Hard PP
- > **Packaging:** Polybag

+ **Hard:** For the very fit and for muscle relaxation (trigger points)

Peanut Shaped Massage Ball



Weight 40gr Category D10

Ø8×16cm

96800

- > **Material:** Soft PP
- > **Packaging:** Polybag

Multicolored Massage Ball

The AMILA massage ball provides deep muscle compression, focusing on relieving pain and muscle fatigue in small areas. It can be used on any surface thanks to its non-slip coating.



Weight 20gr Category D10

Ø6,3cm

96817

- > **Material:** EVA + TPR

Foot Massage Cylinder



Weight 180gr Category D10

Ø7,5×16cm

44011

- > **Material:** Foam coated plastic
- > **Packaging:** Polybag

Thigh Exerciser

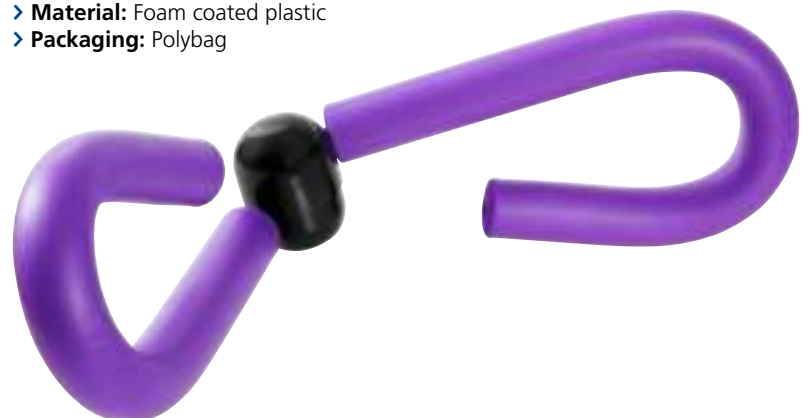

Std Pack 24 Category E6



CORK YOGA

Yoga in a Natural Way

AMILA®



BEST
QUALITY
CORK

HIGH AESTHETICS
& DURABILITY
NATURAL PRODUCT

Nature's Way

This is not yet another Yoga series

The unique properties of the **AMILA Yoga Cork** series makes it a real aid, a training partner in your daily exercise group, superb aesthetics and durability, environmentally friendly. Do not choose your mat from the **AMILA Yoga Cork** series if the standards you have set do not require **the absolute best for you.**

ENVIRONMENTALLY FRIENDLY

Cork is a **100% biodegradable material.** It does not create waste, nor does it destroy nature. It exploits only the fully regeneratable bark of the tree.

NATURAL - ANTIMICROBIAL MATERIAL

Even during extremely demanding workouts, during which more sweat is produced, the **AMILA Yoga Cork** series, in contrast to the usual/simple/plastic materials, remains **clean, without the production of unpleasant odors** (see cleaning instructions). You will never see mold.

NON-TOXIC

The **AMILA Yoga Cork** series is **100% free from chemicals** found in conventional fitness aids.

DURATION

Due to its composition, cork is very **resistant to abrasion and compression.** It is **highly elastic,** having an increased lifespan, without being strained from the daily use during the exercises. It is also **resistant to oils, grease, and salt water** (sweat), which makes it suitable for fitness use.

ANTI-SLIP PROPERTIES

Cork absorbs moisture, thus being the perfect material for your workouts. This very ability **increases traction.**

INSULATING PROPERTIES

Cork is a poor conductor of heat. This property of it **offers absolute neutrality,** both in Hot Yoga and in the contrasts of the weather. Thus, a warm environment doesn't heat up the mattress, so it doesn't make you uncomfortable, and vice versa.

CARE

Daily cleaning is not required; however, cleaning after excessive sweating (possibly after a hot yoga class) is recommended.

Cleaning Instructions



1 Spread a non-toxic cleaner on the surface of the cork.



2 Scrub the stains with a toothbrush or a soft brush.



3 Wipe with a lightly damp towel.



4 Let it dry in a dry and cool place, without exposure to weather extremes, cork side up.

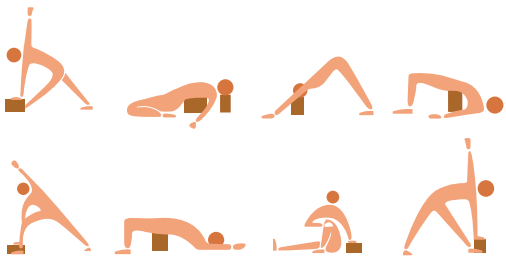

Category D10

Cork Yoga Brick



> Material: Cork 100%

CODE	WEIGHT	DIMENSIONS
48084	750gr	7,6x15x23cm
96810	—	10,0x15x23cm

96805

Cork Roller

> Material: Cork 100%



Weight 800gr Category D10

Ø10x30cm

96809

Cork Peanut Ball

> Material: Cork 100%



Weight 120gr Category D10

Ø8x16cm

> Material: TPE and cork
> Cork thickness: 0,2mm

Cork Yoga Mat



Category D10

CODE	WEIGHT	DIMENSIONS
96811	650gr/m ²	173x61cm x 4mm
96812	950gr/m ²	173x61cm x 6mm



81709

Swing for Aerial Yoga

- > **Dimensions:** Width 2,8m x Length 6m
- > **Elasticity:** Yes, 15%-20% less than #81710
- > **Grips:** —
- > **Colour:** Red
- > **Strength:** 200kg

81702

Swing for Aerial Yoga

- > **Dimensions:** Width 2,8m x Length 6m
- > **Elasticity:** Yes, 15%-20% less than #81710
- > **Grips:** —
- > **Colour:** Blue
- > **Strength:** 200kg

81710

Swing for Aerial Yoga

- > **Dimensions:** Width 2,8m x Length 6m
- > **Elasticity:** Yes
- > **Grips:** —
- > **Colour:** Blue
- > **Strength:** 200kg

81711

Extend Band

- > **Length:** 1,1m
- > **Price:** Per 1 piece (2 pieces are needed for each swing)



81713

Safety Lock

- > **Price:** Per 1 piece (2 pieces are needed for each swing)



81712

Mount

- > **Price:** Per 1 piece (2 pieces are needed for each swing)



Category D10



96921

Swing for Aerial Yoga

81700

Swing for Aerial Yoga

81708

Swing for Anti-gravity Exercises

- > **Dimensions:** Width 2,8m x Length **6m**
- > **Elasticity:** Yes
- > **Grips:** —
- > **Colour:** Black
- > **Strength:** 200kg

- > **Dimensions:** Width 1,5m x Length **5m**
- > **Elasticity:** Yes, 15%-20% less than #81710
- > **Grips:** —
- > **Colour:** Red
- > **Strength:** 200kg

- > **Dimensions:** Width 1,5m x Length **5m**
- > **Elasticity:** No
- > **Grips:** 6
- > **Colour:** Blue
- > **Strength:** 200kg

96920

Swing for Aerial Yoga

81701

Swing for Aerial Yoga

- > **Dimensions:** Width 2,8m x Length **5m**
- > **Elasticity:** Yes
- > **Grips:** —
- > **Colour:** Black
- > **Strength:** 200kg

- > **Dimensions:** Width 1,5m x Length **5m**
- > **Elasticity:** Yes, 15%-20% less than #81710
- > **Grips:** —
- > **Colour:** Blue
- > **Strength:** 200kg



47503

Exercise Mat

With reinforced corners

- > **Filing:** High density PE
- > **Cover:** PVC covered fabric

> **Zipper:** on one side to change the filing



Weight 6,7kg Category D10

200×100×10,0cm

47500

Exercise Mat

With reinforced corners

- > **Filing:** High density PE
- > **Cover:** Water resistant nylon 600D

> **Handles:** 4 for easy transport

> **Zipper:** on one side to change the filing



Weight 5,8kg Category D10

200×120×7,0cm

47504

Exercise Mat

Reinforced corners

- > **Material:** Outside: Non-tearing fabric 550gsm
Inside: EP foam

200×100×10,0cm

47505

200×100×6,0cm



Category D10

47502

Exercise Mat

4ply folding

- > **Dimensions:** 240×120×5 cm
- > **Filing:** High density PE
- > **Cover:** PVC covered fabric
- > **Velcro** on all sides

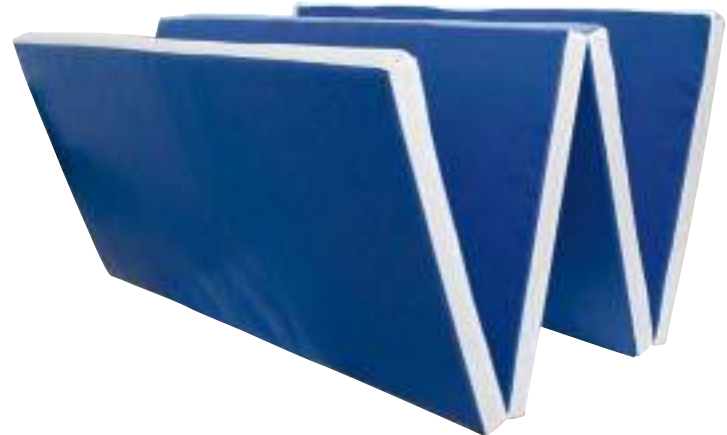

Category D10

240×120×5,0cm

47501

Exercise Mat

- > **Filing:** High density PE
- > **Cover:** Water resistant nylon 600D



- > **Velcro:** on the perimeter to securely join many mats



- > **Zipper:** on one side to be able to change the filling

Βάρος 4,3kg
Κατηγορία Δ10

200×100×4,0cm

47507

Exercise Mat

2ply folding

- > **Velcro** on the seams



Category D10

200×100×6,0cm

44208

Exercise Mat

4ply folding

- > **Material:** Foam (internally)
- > **Packaging:** Clear plastic bag

- **Maximum protection** for floor exercises
- **Adequate protection** for falls



Std Pack 5
Category D10

1800×600×40mm

44206

BEST PRICE

Exercise Mat

- > **Material:** Polyethylene
- > **Packaging:** Nylon bag



- **Simple/Economical** mat for floor exercises
- **It can not** be used for **Yoga** exercises since it does not allow the skin to breathe

Std Pack 5
Category D10

180×60×4,5cm

Στρώματα

Η πιο μεγάλη σύγχυση όταν ξεκινά να κάνει κάποιος **yoga ή pilates** βρίσκεται στο στρώμα που πρέπει να επιλεγεί. Τα στρώματα pilates είναι παρόμοια με τα στρώματα ασκήσεων που συνήθως υπάρχουν στα γυμναστήρια ενώ τα στρώματα yoga διαφέρουν, όχι όμως τόσο πολύ και στην εμφάνιση, με αποτέλεσμα να μεπερδεύουν στην διαδικασία επιλογής. **Τα χαρακτηριστικά τους είναι αυτά που τα κάνουν κατάλληλα για τη μια ή την άλλη μορφή.** Υπάρχουν σημαντικές διαφορές.

Κατηγορίες στρωμάτων Yoga, Pilates και Ασκήσεων Εδάφους

- Από **PVC**. Συνιστώνται για Yoga.
- Από **TPE**. Συνιστώνται για Yoga, χρησιμοποιούνται και για Pilates.
- Από **NBR**. Συνιστώνται για Pilates και Ασκήσεις Εδάφους.
- Από **EVA**. Συνιστώνται για Ασκήσεις Εδάφους, χρησιμοποιούνται και για Pilates.

Το πιο διαδεδομένο υλικό στα στρώμα. Διατίθεται κυρίως σε δυο πάχ (4mm και 6mm) και σε διάφορες ποιότητες, ανάλογα με το **πυκνότητα** (βάρος σε kg/m3), και την **προσθήκη υλικών** που αυξάνουν την αντοχή του στις καταπονήσεις και την εντριβή.

1 Στρώματα PVC

- + Ικανοποιητική αντοχή στην συμπίεση και τις καταπονήσεις.
- + Ικανοποιητική αντιολίσθηση.
- + Ανταγωνιστική τιμή.
- + Ελαφρύ, ευκολία κατά τη μεταφορά.
- Περιβαλλοντολογική επιβάρυνση.
- Μέντριες επιδόσεις.
- Μη φιλική αίσθηση.
- Δεν συνίσταται στα άτομα που παρουσιάζουν αλλεργίες στο PVC.

Μέγιστη
Αντιολισθητικότητα

Πάχος
Στρωμάτων
TPE

- 6mm
- 8mm
- 10mm



2 Στρώματα TPE

Τα **οικολογικά στρώματα** (φιλικά προς το περιβάλλον) είναι κατασκευασμένα από αφρώδη, μη τοξικά, βιοδιασπώμενα ελαστομερή θερμο-πλαστικά (TPE). Τα στρώματα αυτά δεν είναι απλώς οικολογικά και **βιοδιασπώμενα** αλλά και **δίχως latex και PVC**.

- + Αρίστη αντοχή στην συμπίεση η οποία, σε συνδυασμό με τα μεγάλα πάχη, προσφέρει κορυφαία προστασία.
- + Αρίστη σχηματική επαναφορά μετά την συμπίεση (memory foam).
- + Αντιολισθητικότητα, λόγω του υλικού (λάστιχο) και του τρόπου κατασκευής.
- Υψηλό κόστος που το καθιστά επιλογή κυρίως για όσους ασχολούνται εντατικά με το pilates και σε υψηλό επίπεδο (μπορούν να εκτελέσει τις πιο δύσκολες ασκήσεις).

Το στρώμα αποτελείται από δυο υποστρώματα. Στη μέση υπάρχει πλέγμα.



AMILIA

Τι είναι το Pilates

Πέρα από μία μέθοδος γυμναστικής είναι μία **πλήρης μελέτη του ανθρώπινου σώματος**. Η μέθοδος αυτή αναπτύχθηκε στην Αμερική από τον J. H. Pilates που συνδύασε τις βασικές αρχές της yoga και άλλων παραδοσιακών μεθόδων που προέρχονται από ανατολικές φιλοσοφίες με στοιχεία μεταγενέστερων δυτικών μεθόδων.

Οφέλη του Pilates

- Βελτίωση της δύναμης, της ευελιξίας και της ισορροπίας.
- Τόνωση και μυϊκή ενδυνάμωση χωρίς όγκο.
- Δυνατό κοιλιακό.
- Αποκατάσταση της σωστής στάσης και ευθυγράμμισης του σώματος.
- Δημιουργία μιας ισχυρότερης, πιο εύκαμπτης σπονδυλικής στήλης.
- Ενίσχυση της κινητικότητας, της ευκινησίας και της δύναμης.

Τι είναι η Yoga

Η yoga πάνω απ' όλα είναι ένας **τρόπος ζωής**. Ένα ολοκληρωμένο επιστημονικό σύστημα, το οποίο συνδυάζει με απόλυτη αρμονία της άσκησης, όχι μόνο του σώματος αλλά και του νου.

Οφέλη της "Yoga"

- Αύξηση μυοσκελετικής ευλιγισίας και των κινήσεων στις αρθρώσεις.
- Βελτιωμένη στάση του σώματος και της σπονδυλικής στήλης.
- Βελτίωση λειτουργίας αναπνευστικού συστήματος.
- Περισσότερη αντοχή και μυϊκή δύναμη.
- Μείωση ή απαλλαγή από διάφορους σωματικούς πόνους, όπως της μέσης του αυχένα, των καρπών κλπ.
- Βελτίωση της λειτουργίας της καρδιάς. Μείωση της αρτηριακής πίεσης.
- Εύκολος και πιο ξεκούραστος ύπνος.

Στρώματα NBR 3

Τα στρώματα NBR είναι **κατασκευασμένα από ένα είδος φυσικού καουτσούκ που μοιάζει με latex**. Συνήθως είναι παχύτερα των 8mm, έτσι τα NBR στρώματα μπορούν να χρησιμοποιηθούν ακόμα και για ασκήσεις εδάφους.

Το ποσοστό του φυσικού καουτσούκ σε συνδυασμό με την πυκνότητα του υλικού (μέτρηση σε Kg/m³) είναι τα στοιχεία που καθορίζουν την ποιότητα του στρώματος. Η ποσότητα του καουτσούκ (λόγο της διαφοράς κόστους με το PVC) προσδιορίζει και την τιμή του προϊόντος. Όσο περισσότερο τόσο ακριβότερο.

- + Ελαφρύ, σπογγώδες στρώμα.
- + Πολύ καλή προστασία σε όλα τα πάχη η οποία γίνεται εξαιρετική όταν η ποσότητα του φυσικού καουτσούκ είναι μεγάλη ή η πυκνότητα του υλικού ξεπερνά τα 90-110Kg/m³.
- + Αριστη αντοχή στην συμπίεση και άμεση επαναφορά. Ειδικότερα στα στρώματα με μεγάλο ποσοστό φυσικού καουτσούκ.
- + Ευκολία κατά τη μεταφορά, παρότι διαθέτει μεγαλύτερο όγκο από τα στρώματα PVC και TPE/TPU.
- Υψηλό κόστος.
- Ογκωδέστερο των στρωμάτων PVC και TPE/TPU.
- Ευπαθή σε καταπονήσεις και αιχμές. Δεν συνιστάται για επαγγελματική χρήση.

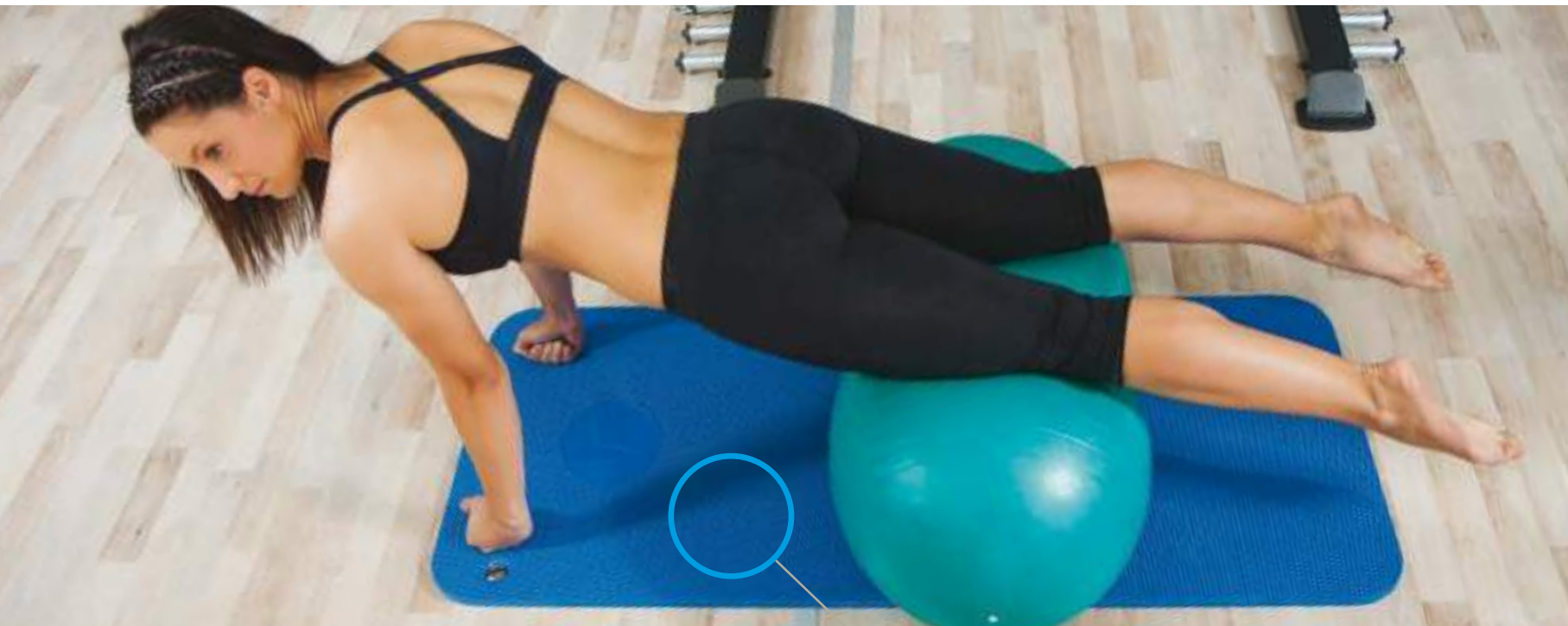

Η εξαιρετική αντοχή των στρωμάτων **EVA** σε συνδυασμό με τον υψηλό δείκτη προστασίας που προσφέρουν, τα καθιστά **ιδανικά για χρήση από γυμναστήρια**.

Διαφορές TPE/TPU και PVC

- Το TPU είναι πιο δυνατό και πιο ανθεκτικό υλικό από το PVC.
- Το TPU είναι άοσμο (φιλικό προς το περιβάλλον) ενώ το PVC μυρίζει, ιδίως σε περιβάλλον με υψηλή θερμοκρασία (ζέστη, καλοκαίρι κ.λπ.).
- Το TPU είναι υλικό υψηλής καθαρότητας έχοντας μεγάλη αντίσταση στην οξειδωση, ενώ το PVC είναι ένα μίγμα υλικών. Έτσι, με το πέρασμα του χρόνου, το TPU διατηρείται καθαρό ενώ το PVC κίτρινίζει και θαμπώνει.

Η "Yoga", επειδή έχει κυρίως ασκήσεις αναπνοής και ευελιξίας δεν έχει μεγάλες απαιτήσεις από τα στρώματα.

- Η Yoga αυξάνει το εύρος της κίνησης σας, την αίσθηση της ευημερίας και μπορεί να μειώσει την πίεση. Το Pilates ενισχύει τον "πυρήνα" σας (π.χ. τους κοιλιακούς, τον κορμό, την κατώτερη σπονδυλική στήλη) και βοηθά να αναπτύξετε τους αδύναμους μύες.
- Η Yoga βοηθά να μάθετε να ελέγχετε την αναπνοή σας. Το Pilates βοηθά να μάθετε να ελέγχετε καλύτερα τη στάση σας.
- Η Yoga είναι γνωστή για την ανάπτυξη δύναμης, σταθερότητας και ισορροπίας. Το Pilates είναι γνωστό για τη δημιουργία μήκους στο σώμα και για το ότι προσφέρει ασφάλεια και έλεγχο. Στην Yoga η εισπνοή και η εκπνοή είναι από τη μύτη. Στο Pilates η εισπνοή είναι από τη μύτη και η εκπνοή από το στόμα.
- Η Yoga εστιάζει περισσότερο σε αναπνευστικές ασκήσεις ώστε να "διευρύνει" το σώμα μέσα και έξω. Αποκτάει κανείς συντομότερα καλύτερη φυσική κατάσταση, διότι έχει πιο δυναμικό πρόγραμμα. Η μέθοδος Pilates είναι ένα πρόγραμμα πιο στατικό το οποίο γυμνάζει εξίσου όλο το σώμα, αλλά απαιτείται λιγότερη προσπάθεια.

Τα **EVA** υψηλής πυκνότητας είναι η τελευταία εξέλιξη στην αγορά των στρωμάτων και **στοχεύουν κυρίως σε αυτούς που εκτελούν ασκήσεις εδάφους**.

4 Στρώματα EVA

- + Υψηλής πυκνότητας υλικό που προσφέρει κορυφαία προστασία.
- + Εξαιρετική αντοχή στον χρόνο, ιδανικό για επαγγελματική χρήση.
- + Αίσθηση.
- + Μικρό βάρος.
- Υψηλό κόστος το οποίο όμως αποσβένετε γρήγορα.
- Δυσκολία κατά τη μεταφορά. Συνιστάτε η χρήση από γυμναστήρια.

Yoga VS Pilates

81727

Mat Bag



Category D10

69 x 14 cm

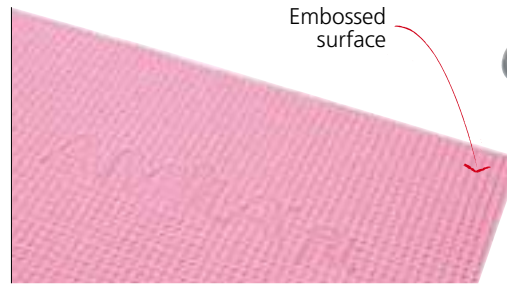

Embossed surface



Yoga Mat

Caution: These mats, under certain conditions and floor texture, can be slippery



Category D10

CODE	WEIGHT	DIMENSIONS	COLOR
96751	860gr/m ²	173x61cm x 4mm	Grey
96752			Olive Green
81715			Purple
81721			Pink
81705			Blue
81704			Black
96753	1100gr/m ²	173x61cm x 6mm	Grey
96754			Olive Green
81703			Black
81707			Purple
81706			Pink
81716			Blue



Yoga Mat

> Material: TPE

Much better than the PVC mats

- + High durability due to the materials used
- + Do not lose their grip even after a long time
- + Very pleasant texture, extremely comfortable
- + Ecological

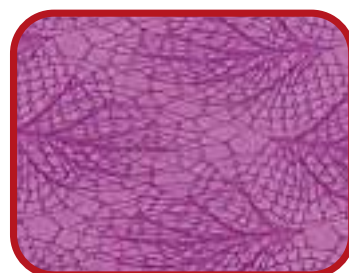

They have a mesh embedded between the two layers, increasing their anti-skid properties

CODE	MESH	DIMENSIONS	COLOR
81772	Yes	173x60cm x 8mm	Black/Grey
81748	No	173x60cm x 6mm	Black/Purple
81778	Yes		Blue/Cyan
81771	Yes	173x60cm x 4mm	Pink/Purple

Category D10

81777

> **Material:** **TPE** on the bottom for support and cushioning, **RUBBER** on the top for traction and durability



Category D10

Yoga Mat

150×61cm × 8mm

81779

> **Material:** **TPE** on the bottom for support and cushioning, **SUEDE** on the top for traction and luxurious feel



Category D10

Yoga Mat

173×60cm × 6mm

96760

> **Material:** **Natural rubber** on the bottom for optimum anti-slip performance, **PU** on the top for great feel and protection from sweat

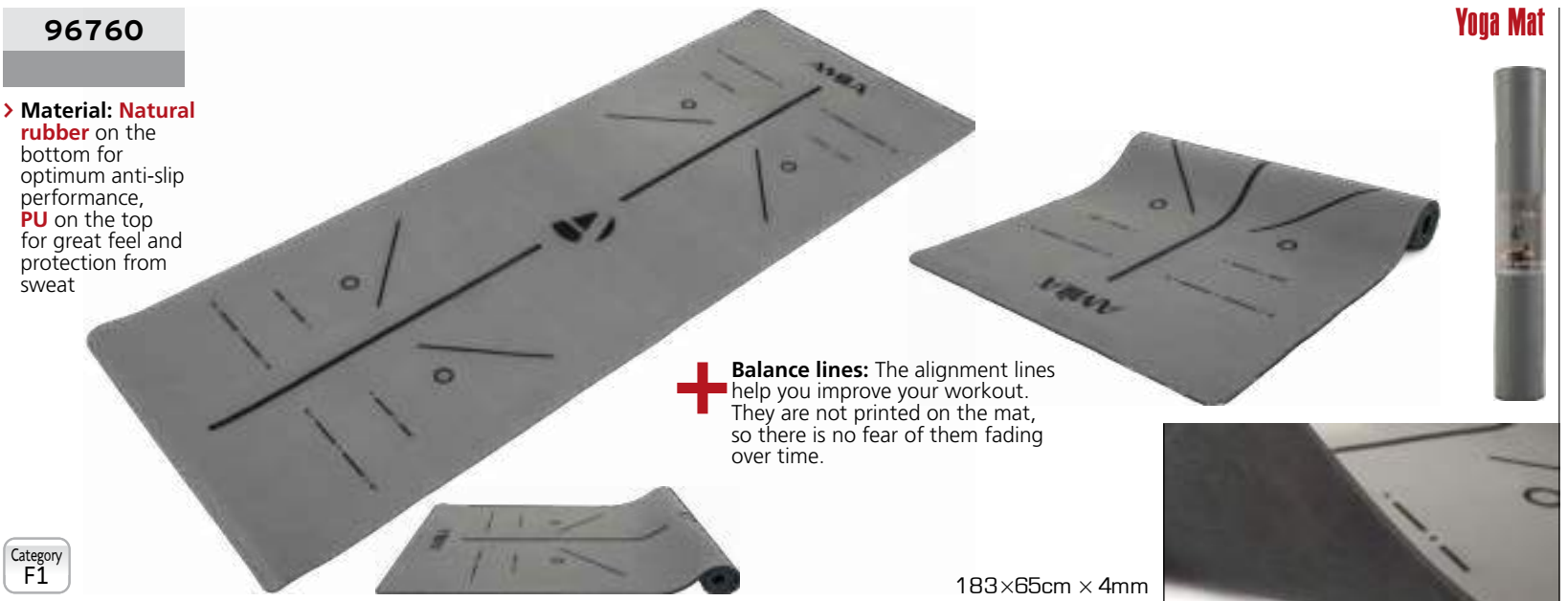

Category F1

Yoga Mat

+ Balance lines: The alignment lines help you improve your workout. They are not printed on the mat, so there is no fear of them fading over time.

183×65cm × 4mm

> Material: NBR 70kg/m³

Enormous Exercise Mat

- The only one with a width of 80cm



- No more being afraid of "falling off" your mat when exercising

CODE	STORAGE	DIMENSIONS
81774	Belt	1800x800x10mm

Std Pack 6 Category D10

> Material: TPE/EVA in 25-75% percentage, top EVA 90kg/m³ to be strong enough for use and bottom TPE to be anti-skid

Exercise Mat

- The 2 materials are bonded together by the heat of the hydraulic press
- Easy to clean since it does not absorb water/sweat



- Long lasting and durable
- Honeycomb texture on one side



CODE	STORAGE	DIMENSIONS
81764	Eyebolts	1200x600x16mm

Category F1

> Material: NBR, a new foam material offering high protection and increased comfort

Std Pack 10 Category F1



Pilates Mats



Weight of the material

- > **80 kg/m³**: The most common quality
- > **90 kg/m³**: Gym quality. Bigger protection and service life, but also weighs more and is more expensive
- > **100 kg/m³**: The highest quality. Offers superb protection, the thickness needs not exceed 12mm, offering protection equivalent of mats 15mm thick with a weight of 90kg/m³, with the convenience of a smaller volume

NBR (Nitrile Butadiene Rubber)

Since 2012, NBR is the industry standard and the preferred material for gym mats because of its high protection and comfort level it offers when compared to other materials, also because of the ease when storing and transporting. Its quality mainly depends on two factors:

1. The knowledge, experience and processing of the factory, time spent processing and foaming process.
2. Also on the the density, which is expressed by the weight of the material per cubic meter.

The weight affects the density, which has a direct relationship with the comfort it offers. Durability: under no circumstances does this material have the durability of EVA; this is the reason gyms have began using EVA mats in our days.



Length of mat

- > **140cm**: Recommended for aerobics
- > **180cm**: Ideal for Pilates

CODE	WEIGHT	DIMENSIONS	STORAGE	COLOR
81730	80Kg	183x60cm x 15mm	Belt	Grey
81776				Black
95911				Grey
95910				Black
95904	90Kg	142x60cm x 12mm	Belt	Grey
95905				Black
81782				Blue
95902				Grey
95903	100Kg	183x60cm x 15mm	Eyebolts	Black
81781				Blue
95901				Black
81734				Blue



Pilates Mat
 > Material: EVA

Προσφέρει **εξαιρετική προστασία και μεγάλη αντοχή**. Το πλέον κατάλληλο για επαγγελματική χρήση σε γυμναστήριο.

Πλεονεκτήματα και Μειονεκτήματα Στρωμάτων EVA

- + Υψηλής πυκνότητας υλικό που προσφέρει κορυφαία προστασία.
- + Εξαιρετική αντοχή στο χρόνο, ιδανικό για επαγγελματική χρήση.
- + Αίσθηση.
- + Μικρό βάρος.
- Υψηλό κόστος, το οποίο όμως αποσβένεται γρήγορα.
- Δυσκολία κατά τη μεταφορά, συνίσταται χρήση σε γυμναστήρια.



SCAN HERE
 Promo video on our YouTube channel.

CODE	STORAGE	DIMENSIONS	COLOR
81735	Eyebolts	140x60cm x 15mm	
81744			
81745			
81766		120x60cm x 16mm	
81750			
81740			
81749	100x60cm x 15mm		

Category **F1**

88263

- > Tubes: 6x10,6mm x 40cm
- > Height: Max 179cm, min 109cm

+ Easy height adjustment

Pull-up Straps with Tubing



+ Safety lock



+ Easy to fasten



Std Pack **25** Category **D10**

Ideal for use during exercises involving **lifting** or **lowering** in all possible positions. It helps to **stabilise** and adds height for better **balance** or is placed between the knees in order to **activate** the inner leg muscles.

Improve your flexibility and balance

Securely place your body in the correct position

AMILA®

Yoga Block
The best way to do Yoga

Made from high-quality non-toxic foam

Special design, without edges, for added comfort and ease of use

Extremely durable



Yoga Block

Ideal for Yoga and special exercises

CODE	COLOR	
48083		<ul style="list-style-type: none"> > Material: EVA > Weight: 140gr > Dimensions: 23×14,5×7,5cm > Packaging: Gelatin with paper hanging ribbon
96840		
96841		
96842		
96843		
96844		



Yoga Belt

Ideal for Yoga exercises

48087

- > **Material:** Cotton
- > **Width:** 4cm
- > **Length:** 195cm
- > **Packaging:** Nylon bag

The belt **helps making exercising easier**. It is particularly useful for those starting Yoga and want to have less pressure.

Feeling tight? The belt can **help you progress to more difficult asanas** to gain flexibility faster.

It is **the oldest** and **most basic Yoga accessory** that can be used as an exercising aid.

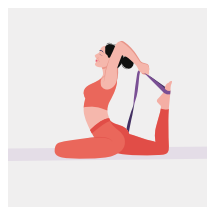

Std Pack
100

Category
D10

48232

- > **Material:** MicroFiber
- > **Dimensions:** 70×150cm

Characteristics

- Ideal for use on exercise mats.
- Fast drying.
- Great absorbency.



Category D10

Mat Towel
Training Towel

- > **Material:** 50% Polyester, 50% Polyamid
- > **Dimensions:** 30×100cm

Characteristics

- The best towel for hard workouts. The highly absorbent fibers absorb the sweat and immediately cool the skin.
- Wet the towel, wring and shake it for a few seconds.
- While wet, it stays cool for up to 2 hours.
- Wash at a temperature of 30°C after use.
- Does not need ironing.
- Provides immediate relief from (sports) injuries, on the neck and joint pain.
- Prevents sunstroke.
- Cools the head when you have a fever, headache or sunburn.



CODE		COLOR
96901		Green
96902		Blue

Category D10

96907

- > **Material:** 96% super-soft 550gsm cotton, 4% polyester
- > **Zipper:** YKK
- > **Dimensions:** 118×43cm

- **With magnet** to easily fasten to Racks etc.

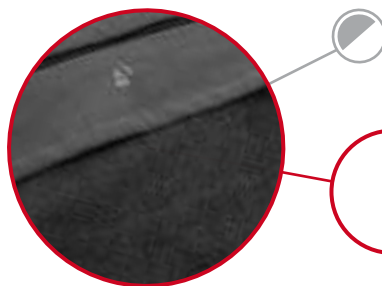

Stitched pocket on the back to safely attach to the top of exercise benches



Zippered accessory pouch



Lewot Plus
Gym towel

Category D10

- > **Material:** Cotton (Code #96835 from organic cotton)
- > **Width:** 3,8cm
- > **Length:** 240cm

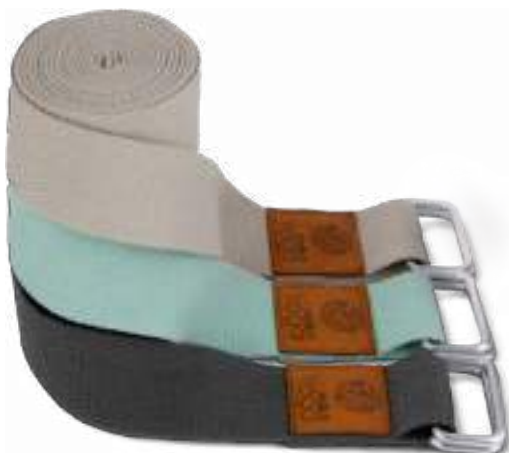

Code 96835
Made of 100% Organic Cotton

Yoga Belt
Ideal for Yoga exercises



CODE	PRICE	COLOR
96831		Charcoal
96832		Mint
96833		Natural
96834		Purple
96835		Organic Natural*

PCS 1

Category D10



PILATES

Reformer Non-Slip Towel

AMILA®
TOWEL

Specially designed to fit perfectly on Reformer Beds



Anti-slip silicone tringles on the pack side for added safety while exercising

2 Special covers for the Pilates bed (included with code 96905)

96903

Reformer Towel

SPECIFICATIONS

Dimensions: 96,0x58,0 cm
Material: Sueded Microfiber
Weight: 200gsm
Logo: Printed
Category: D10

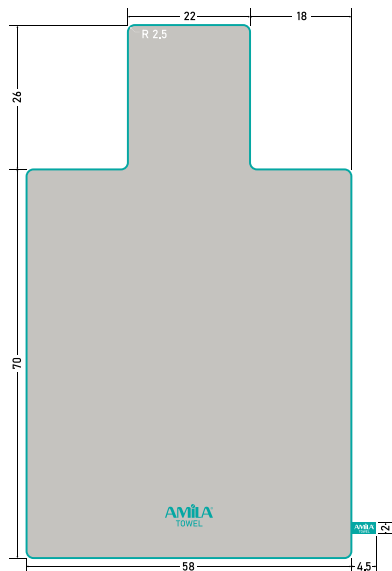

96905

Reformer Towel Pro

» Ability to use your logo (printed or stitched)

SPECIFICATIONS

Dimensions: 97,0x58,0 cm
Material: Fancy
Weight: 300gsm
Logo: Stitched
Category: D10

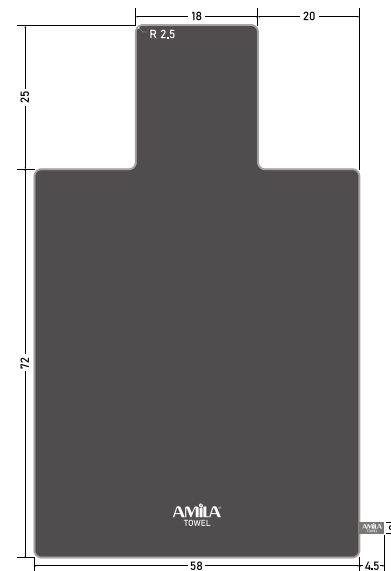

3 in 1 Training Equipment

1

Standard use: The most traditional way to use the Spine Corrector Box has to do with taking advantage of its arched design and its curve, supporting the spine for performing roll down exercises

2

Wedge: Place the Spine Corrector Box on the reformer pads and use it as a wedge. This way back support will be provided to those needing it

3

Plank: By removing the step, it is transformed to a balance board which can increase the difficulty of many exercises



Why should I use the Spine Corrector Box?

Its use is extremely beneficial to the body and how it behaves in your daily life, improving its quality.

It increases the strength and stability of your torso, improves spinal mobility, strengthens the upper part of the body and develops its balance and coordination.



3 locking positions
for the Pilates bed



Material: EPP

SPECIFICATIONS

Dimensions: 96,5x37,0x37,0 cm

NET weight: 1,5 kg

Category: D10

44084

AB Mat

- Non-slip lower side

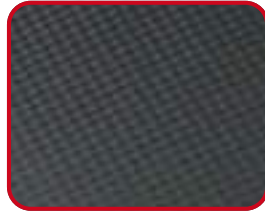

- Woven heavy duty vinyl

Category F1

84627

AB Mat

- > Improved quality with better and thicker foam for added protection



- + Better finishing

Category F1

30,5×36,5cm

44085

- Offers 3 different heights



Category F1

AB Mat

81798

Adjustable Yoga Cushion

Removable, washable, breathable external fabric, with antimicrobial lining



Useful for stretching and correcting your bones and skeleton and bring them back to correct positions

- > **Dimensions:** 59x25x3~11cm
- > **Material:** Internal: Cold Memory Foam, density 80kg/m³ with excellent air permeability, providing the right amount of softness
External: Breathable/washable fabric with antimicrobial lining
- > **Range:** Upward/downward 4cm



Easy to adjust height with the turn of a knob

Weight 1.9Kg Std Pack 5 Category D10

81797

Adjustable Lumbar Cushion

Removable, washable external fabric



2-in-1 actuator for in/out and up/down movement

- Ergonomic contoured design to fit the lumbar curve
- Ideal for bigger seating, such as high back chairs, couches etc.
- > **Dimensions:** 470x375x125mm
- > **Material:** Internal: Memory Foam
External: Breathable/washable fabric
- > **Range:** Upward/downward 70mm
Inward/outward 25mm



Weight 2.5Kg Std Pack 5 Category D10

AMILA Foam Rollers

The perfect tool to increase blood circulation and toning strained muscles. It prepares the muscles for the exercise that will follow, or any kind of activity.



Follow us on social media and be the first to learn about what is new in fitness



AMILA®

Prevents Injuries
Rehabilitation
Recovery
Warm-up
Improves Flexibility



Exercise book in packaging



QUADRICEPS



LATISSIMUS DORSI



ILIOTIBIAL BAND



GROIN



HIPS



BACK/WAIST

Reasons to use AMILA Foam Rollers:

Performance Enhancement: A strained muscle can limit you and reduce your performance. When you use the AMILA Foam Rollers, you can bring your muscles back to normal, increasing your range of motion. This way you can achieve a better performance, as the muscles (which will have recovered) will be able to be fully used.

Fast Recovery: Exercising with the Foam Roller helps the muscle recover.

Relieves Pain: When you use MFR (Myofascial Release, Self-myofascial Release) methods on the active/afflicted parts of your muscles that trigger pain, you increase blood circulation to the muscles and connective tissues. The better the circulation, the more oxygen gets through, meaning your muscle can recover faster or even hurt less.

- > **Material:** EPP
- > **Packaging:** Nylon bag

Soma

Unlock the hard-to-reach trigger points

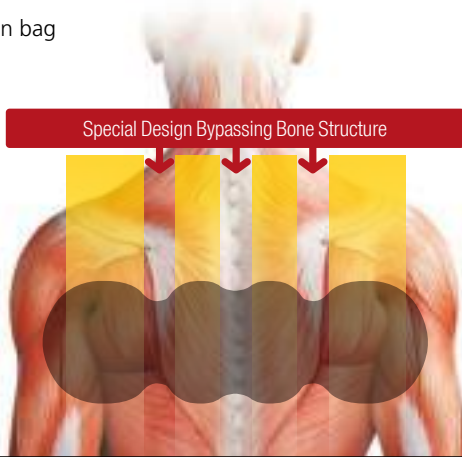

Expanded Polypropylene (EPP)

Expanded Polypropylene (EPP) is a flexible cellular foam offering energy absorption and extremely high ration of endurance compared to weight. It is 100% recyclable and can be produced in a wide range of densities. It is inherently harder than EVA and PU.

DIAMETER	LENGTH	WEIGHT	HARDNESS	COLOR	CODE	
			●○○		96801	
Ø15cm	45cm	260gr	●●○		96802	
			●●●		93803	

Std Pack 10 Category D10

- > **Material:** EPP
- > **Roughness:** Rough
- > **Packaging:** Nylon bag

Spike



Button-shaped logo

Expanded Polypropylene (EPP)

Expanded Polypropylene (EPP) is a flexible cellular foam offering energy absorption and extremely high ration of endurance compared to weight. It is 100% recyclable and can be produced in a wide range of densities. It is inherently harder than EVA and PU.

DIAMETER	LENGTH	WEIGHT	HARDNESS	COLOR	CODE	
Ø14cm	32cm	130gr	●●●		96818	

Std Pack 20 Category D10

- > **Material:** EPP
- > **Roughness:** Smooth
- > **Packaging:** Nylon bag

Foam Roller EPP Pro



Embossed logo

Expanded Polypropylene (EPP)

Expanded Polypropylene (EPP) is a flexible cellular foam offering energy absorption and extremely high ration of endurance compared to weight. It is 100% recyclable and can be produced in a wide range of densities. It is inherently harder than EVA and PU.

DIAMETER	LENGTH	WEIGHT	HARDNESS	COLOR	CODE	
Ø15cm	90cm	450gr	●●●		96825	

Std Pack 10 Category D10

- > **Material:** PU
- > **Tube:** ABS
- > **Packaging:** Nylon bag

Purse

- + Made of injection-moulded PU
- + Doesn't have the "stretch marks" of heat treatment



Special for small items internal storage space (towel, bands, keys etc.), securing with a lid.

+ **Triple service life**

DIAMETER	LENGTH	WEIGHT	HARDNESS	COLOR	CODE	
Ø13cm	42cm	1000gr	●●○		81791	

Std Pack 10 Category D10

- > **Material:** EVA
- > **Roughness:** Medium
- > **Packaging:** Nylon bag



Foam Roller Pro

DIAMETER	LENGTH	WEIGHT	HARDNESS	COLOR	CODE	
Ø15cm	90cm	730gr	●○○		48069	
	30cm	260gr			96823	
					48068	
					96824	

Std Pack 12 Std Pack 20 Category D10

- > **Material:** EVA
- > **Tube:** PP
- > **Packaging:** Nylon bag



Levels

The surface is designed to simulate a massage therapist's hands

DIAMETER	LENGTH	WEIGHT	HARDNESS	COLOR	CODE	
Ø14cm	60cm	1000gr	●●●		96807	

Std Pack 10 Category D10

- > **Material:** EVA
- > **Tube:** ABS
- > **Packaging:** Nylon bag



Plexus 33

DIAMETER	LENGTH	WEIGHT	HARDNESS	COLOR	CODE	
Ø14cm	33cm	700gr	●●●		96806	
					96821	
					96826	
					96822	

- > **Material:** EVA
- > **Tube:** ABS
- > **Packaging:** Nylon bag



Plexus 45
Foam Roller

DIAMETER	LENGTH	WEIGHT	HARDNESS	COLOR	CODE	
Ø14cm	45cm	1200gr	●●●		96827	

Std Pack 10 Category D10

Τα λάστιχα αλλά και οι ιμάντες είναι κατασκευασμένοι από **φυσικό Latex**. Η καλύτερη ποιότητα φυσικού Latex, είναι το Καουτσούκ που βγαίνει από τα δένδρα της Μαλαισίας (rubber tree). Τα χαρακτηριστικά του φυσικού Latex **που συναντάμε συνήθως στην αγορά** είναι:

- + Μεγάλη επιμήκυνση (μέχρι και 5 φορές).
- + Διάρκεια ζωής (αυξημένη 10-20% περισσότερο από τα Latex free).
- Όχι απόλυτη γραμμικότητα της αντίστασης.
- Το γαλακτώδες υγρό του φυσικού λάστιχου δημιουργεί αλλεργίες εξ αίτια των πρωτεϊνών που περιέχονται σε αυτό.
- Χρειάζεται να πουδραρισθεί για να μην έχει την αίσθηση της κόλλας.

Πόσο καιρό μπορεί να χρησιμοποιείτε μια ζώνη αντίστασης;

Οι ζώνες αντίστασης της **Sanctband** είναι **κατασκευασμένες από υψηλής ποιότητας καουτσούκ**, όμως δεν παύει να είναι ένα ελαστικό. Αν προσεχθεί (δεν χρησιμοποιηθεί σε τραχείς επιφάνειες, δεν τεντώσει πάνω από το μέγιστο μήκος, δεν εκτίθεται στον ήλιο κ.λπ.) η ζωή **μπορεί να διαρκέσει από 3 μήνες έως και 1 χρόνο**, υπό κανονικές συνθήκες (οικιακής χρήσης/άτομο).

Χαρακτηριστικά Sanctband



Χωρίς Πούδρα: Τα προϊόντα της Sanctband έχουν εξαλείψει την ανάγκη για χρήση πούδρας.



Χαμηλή Πρωτεΐνη: Ελαχιστοποίηση των αλλεργικών παθήσεων με την απομάκρυνση των πρωτεϊνών από το γαλακτώδες καουτσούκ.



Διάρκεια Ζωής: Υλικά ανθεκτικά στις επαναλήψεις που βελτιώνουν 10% της διάρκειας ζωής του ελαστικού.



Αποτελεσματικότητα: Εξασφαλίζουν την γραμμικότητα της αντίστασης κατά την επιμήκυνση του ελαστικού.



Ασφάλεια: Διατηρούν τις ιδιότητές τους -δίχως θραύση- ακόμα και με 500% επιμήκυνση.



Φιλικά στο Περιβάλλον: Τα προϊόντα της Sanctband κατασκευάζονται με μεθόδους φιλικούς στο περιβάλλον, από καθαρή ενέργεια, μικρής κατανάλωσης και μειωμένου όγκου αποβλήτων.

Επιμήκυνση

Επιμήκυνση από 100% σε 200% υποδηλώνει την αντίσταση που παρέχετε από το ελαστικό όταν τεντώνει από 2 σε 3 φορές περισσότερο (έχει γίνει διπλάσιο ή τριπλάσιο) του αρχικού του μεγέθους.

Για παράδειγμα, αν μια ζώνη αντίστασης έχει μήκος 1 μέτρο, όταν επεκταθεί στα 2 μέτρα τότε το έχετε κάνει διπλάσιο (100% πάνω) του κανονικού μήκους ηρεμίας.

Σημείωση: Η δύναμη αντίστασης εφαρμόζεται σε οποιοδήποτε μήκος της ζώνης και αν τεντωθεί, όχι μόνο σε ολόκληρο το μήκος. Εάν δηλαδή ένα τμήμα 40cm τεντωθεί έως το 1,2m, τότε έχει γίνει τριπλάσιο (τεντώθηκε 200%) του μήκους ηρεμίας του.

Sanctband

"**Λάστιχα/Ελαστικά Αντίστασης**", "**Σωλήνες Αντίστασης**" ή "**Ζώνες Αντίστασης**" είναι ένας γενικός όρος για κάθε ελαστικό σωλήνα ή ζώνη (μπάντα, λεπτή ταινία) που χρησιμοποιείτε για τις ασκήσεις ενδυνάμωσης (π.χ. ασκήσεις αντίστασης), δηλαδή τις ασκήσεις που εφαρμόζεται στο σώμα μια δύναμη αντίστασης η οποία είναι μεγαλύτερη από την κανονική.

Αυτή η δύναμη μπορεί να παρέχεται κάνοντας χρήση μηχανημάτων, αλτήρων και άλλων παρεμφερή βαρών (kettlebells κ.α.) ή **ελαστικών αντίστασης**.

Το σώμα δεν μπορεί να καταλάβει διαφορές στις ασκήσεις ενδυνάμωσης που γίνονται κάνοντας χρήση οργάνων, μεταλλικών βαρών ή ελαστικών αντίστασης. Οι μύες θα εξακολουθούν να δυναμώνουν σε όλες τις περιπτώσεις.

Η **Sanctband** είναι Μαλαισιανή εταιρεία και έχει στην ιδιοκτησία της ένα από τα τρία (3) εργοστάσια στην Μαλαισία που παράγουν λάστιχα και ιμάντες από **φυσικό Μαλαισιανό Latex**.

Έχει αναπτύξει δικές της μεθόδους παραγωγής που **επιλύουν τα αρνητικά σημεία του φυσικού Latex** και **βελτιώνουν την απόδοση**.

Γιατί θα πρέπει να δοκιμάσετε τα "exercise band" της Sanctband;

- **Φορπτότητα - ευκολία στην μετακίνηση** Ο εξαιρετικά μικρός τους όγκος, σε συνδυασμό με το ελάχιστο βάρος τους, καθιστά την μεταφορά εφικτή από οποιαδήποτε αποσκευή, ακόμα και μέσω της τσάντας που χρησιμοποιούμε στην καθημερινότητά μας.
- **Ομαλότητα** Η προοδευτική γραμμική αύξηση της αντίστασης κατά την ένταση των ασκήσεων προσφέρει ομαλότητα στο σώμα, ειδικότερα στις αρθρώσεις.
- **Αύξηση της ισορροπίας και της ικανότητας συντονισμού του σώματος** Επειδή υπάρχει αρκετή ένταση κατά τη διάρκεια των ασκήσεων, το σώμα πρέπει να είναι σταθεροποιημένο. Η εκτέλεση ασκήσεων με λάστιχα γυμναστικής απαιτεί υψηλές ικανότητες συντονισμού (με την άσκηση και την ισορροπία του σώματος), κάτι που επί τις ουσίας γυμνάζει επιπλέον μύες και **είναι πολύ διασκεδαστικό!**
- **Ποικιλία** Η δυνατότητα να **μεταβάλλεται συνεχώς η ένταση** για να γίνει η εκγύμναση περισσότερο ή λιγότερο δυναμική **δίχως παύσεις** σε συνδυασμό με την **εκτέλεση πολύπλοκων ασκήσεων**, που δεν μπορούν να γίνουν εύκολα (ή και καθόλου) με χρήση μηχανών ή ελεύθερων βαρών, κάνει τα exercise bands τη μοναδική λύση για αυτές τις απαιτήσεις.
- **Κόστος** Κανένας άλλος εξοπλισμός για ασκήσεις ενδυνάμωσης δεν προσφέρετε σε ελκυστικότερες τιμές. Ακόμα και αν επιλεγούν 2, 3 ή και 4 λάστιχα με διαφορετικά επίπεδα αντίστασης, το συνολικό κόστος είναι πολύ μικρότερο από οποιοδήποτε άλλο προϊόν.
- **Ιδανικά για όλα τα επίπεδα φυσικής κατάστασης** Ο τρόπος που χρησιμοποιούνται τα καθιστά ιδανικά τόσο σε αρχάριους όσο και σε προχωρημένους. Μπορούν να χρησιμοποιηθούν από βασικές κινήσεις μέχρι την προσθήκη έντασης σε εξειδικευμένες ασκήσεις.

Tip * 1N = 0,102gr

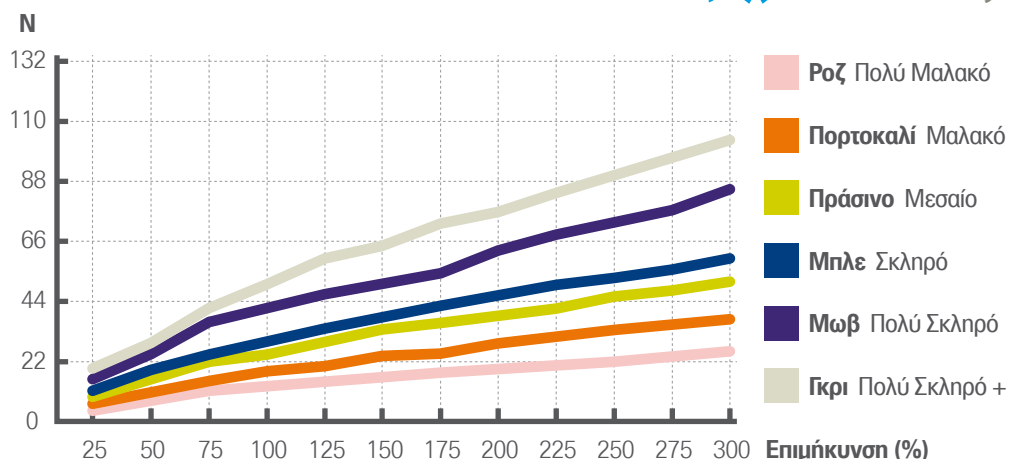

Sanctband™ Tubing With Handles
Better in. Everyony.



> Length: 120cm

- With door anchor included

CODE		THICKNESS	HARDNESS	COLOR	RESISTANCE
					200%
88220		1,4mm	Very Soft		2,5Kg
88221		1,7mm	Soft		2,5Kg
88222		2,0mm	Medium		4,0Kg
88223		2,3mm	Hard		5,0Kg
88224		2,6mm	Very Hard		5,5Kg



Category D10

Sanctband™ Active Tubing With Handles
Better in. Everyony.



> Length: 150cm

- With door anchor included

CODE		THICKNESS	HARDNESS	COLOR	RESISTANCE
					200%
88265		1,7mm	Soft		3,5Kg
88266		2,0mm	Medium		4,0Kg
88267		2,3mm	Hard		5,0Kg
88268		2,6mm	Very Hard		5,5Kg
88269		2,9mm	Very Hard +		6,5Kg

Category D10



Sanctband™ Restrictive Band
Better in. Everyony

> Length: 2,0m x 15cm • With door anchor included

Category
D10

CODE	THICKNESS	HARDNESS	COLOR	RESISTANCE
				200%
88303	0,30mm	Hard		3,2Kg
88304	0,40mm	Very Hard		4,3Kg
88305	0,45mm	Very Hard +		5,1Kg



> Length: 1,5m x 15,0cm

Category
D10

CODE	THICKNESS	HARDNESS	COLOR	RESISTANCE
				200%
88201	0,20mm	Soft		2,1Kg
88202	0,25mm	Medium		2,6Kg
88203	0,30mm	Hard		3,2Kg



Sanctband™ Restrictive Band Roll
Better in. Everyony



> Length: 46m x 15cm

Category
D10

CODE	THICKNESS	HARDNESS	COLOR	RESISTANCE
				200%
88214	0,40mm	Very Hard		4,2Kg
88215	0,45mm	Very Hard +		5,2Kg



Sanctband™ Loop Band
Better in Everyway

> Length: 33cm
> Width: 5cm

CODE	THICKNESS	HARDNESS	COLOR	RESISTANCE
				200%
88230	0,30mm	Very Soft		2,4Kg
88231	0,50mm	Soft		3,8Kg
88232	0,70mm	Medium		5,3Kg
88233	0,90mm	Hard		7,0Kg

Category D10



Sanctband™ Active Super Loop Band
Better in Everyway

> Length: 104cm
> Thickness: 4,8mm

CODE	WIDTH	HARDNESS	COLOR	RESISTANCE
				200%
88273	1,27cm	Soft		7,30Kg
88275	2,54cm	Hard		14,50Kg
88276	3,49cm	Hard +		19,90Kg
88277	4,45cm	Very Hard		24,60Kg
88278	5,72cm	Very Hard +		32,00Kg
88279	6,35cm	Very Hard ++		33,80Kg

Category D10

- > **Material:** 100% natural latex
- > **Length:** 208cm
- > **Width:** 5cm



Floss Band

> **Benefits:** The Floss Band is an essential performance tool and should be a staple in the gym bag of every athlete looking to improve range, restore joint mechanics, or unglue matted down or previously injured tissue. Compression tuck and flossing works on many levels; including re-perfusing tissues that have become stiff or gone cold after injury, and by compressing swelling out of tissues and joints.



> **Thickness:** Thicker band provides more compression and is better suited in difficult areas like the high hips. This band is also great for larger athletes like powerlifters and strongmen when more compression is needed.

Category D10

CODE	THICKNESS
96950	1,00mm
96951	1,30mm
96952	1,50mm



Sanctband™ Comprefloss Floss Band
Better in Everyway

> Length: 200cm
> Width: 5cm

CODE	THICKNESS	HARDNESS	COLOR
88281	1,10mm	Soft	
88282	1,30mm	Medium	
88283	1,60mm	Hard	
88284	1,80mm	Very Hard	

Category D10

Fabric Hip Band

- > **Material:** Nylon/Latex
- > **Perimeter:** 68,6cm
- > **Thickness:** 2,2mm

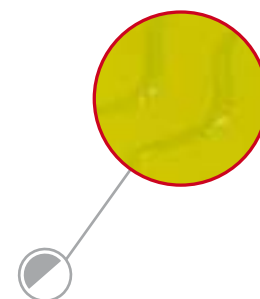

Inner wavy silicon anti-slip lines



SCAN HERE and watch exercise videos on our YouTube channel.

CODE	COLOR	HARDNESS	WIDTH	RESISTANCE
96620		Light	6cm	12,70Kg
96621		Medium	7cm	17,25Kg
96622		Heavy	8cm	21,80Kg

Std Pack 100 Category D10

Fabric Small Loop Band 76

- > **Material:** Latex (outer), Cotton (inner)
- > **Perimeter:** 76cm
- > **Width:** 8cm
- > **Packaging:** Hangable Box



Easily Distinguishable Levels
The fabric resistance belts are color coded to ease selection.

CODE	COLOR	HARDNESS	RESISTANCE
88291		Light	5-10Kg
88292		Medium	10-20Kg
88293		Heavy	20-30Kg

Category D10

88246

- > **Material:** Latex (inner), Cotton (outer)
- > **Resistance:** 5-10Kg
- > **Perimeter:** 86cm
- > **Width:** 8cm
- > **Packaging:** Nylon bag



Fabric Small Loom Band 86

Fabric Resistance Belt
XXL (Ø86cm), ideal for large people



Std Pack 160 Category D10

Multi Loop Resistance Band

- > **Material:** Nylon/Polyester/Latex
- > **Length:** 112cm



SCAN HERE and watch exercise videos on our YouTube channel.

Std Pack 72 Category D10



CODE	COLOR	HARDNESS	WIDTH	RESISTANCE
96623	Orange	Light	5cm	6 Kg
96624	Yellow	Medium		8 Kg
96625	Blue	Heavy		10 Kg

88186



"D" Rings for easy adjustment and change of resistance

Tubes with Sleeves for maximum durability

Straps with reinforced neoprene lining and strong velcro

Std Pack 30 Category D10

Abductor Set

If your choice of training your abductors is nothing short of the best, then the **AMILA** abductor set is the way to go. The kit includes **2x Straps**, with **reinforced neoprene lining for maximum protection and ease**, **2x Tubes with Sleeves** (medium resistance) and

1x Transport/Storage Pouch. The adjustable straps allow you to loosen or tighten the cuffs using the strong velcro and attach the tubes to the "D" type rings. Easy to wear and adjust to the desired fit; compatible with typical resistance systems with clips.



88186006

Abductor Straps for Abductor Tubes with reinforced neoprene lining and strong velcro

- > **Strap Width:** 6,5cm
- > **Ring:** "D" type
- > **Packaging:** Nylon bag

Reinforced Neoprene
Reinforced neoprene lining for the absolute feeling of safety and comfort



PCS 2 Std Pack 30 Category D10

- > **Length:** 35cm
- > **End:** Clip
- > **Packaging:** Nylon bag

Abductor Tubes for Abductor Straps with clips and sleeves

Color Coded
Easily choose the right resistance

Reinforced Finish
Protects the links to prevent damage and corrosion

Sleeves
Special protection of the tubes for maximum durability



CODE	COLOR	RESISTANCE
88186001	Red	● ○ ○
88186002	Green	● ● ○
88186003	Blue	● ● ●

PCS 2 Std Pack 30 Category D10

AMILA®

PREPARATION | FLEXIBILITY | TONING | HEALING

POWERBAND

Healing

After intense training, the muscles tighten, resulting in pain, stiffness and an increase to cramps.

AMILA PowerBand, providing leveraging and resistance, allows for larger stretches without pressuring the already strained muscles.

The resulting lengthening of the muscles finally assists their complete relaxation, which can shorten the recovery time and improve overall performance.

Flexibility

AMILA PowerBand helps improve flexibility and control of strength while stretching, so that each part of the joint works securely.

Much more than a simple exercise tool

Some good stretches help relaxing the muscles or preventing them cramping, even after a long journey

STRETCH THERAPY



PowerBand

- > **Material:** Polyester + Latex
- > **Packaging:** Box

Scan here and discover your first exercises with AMILA PowerBand.

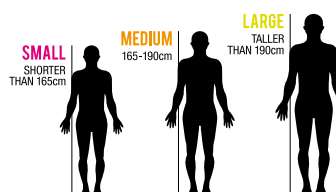

Find what suit you best

AMILA PowerBand can be used by people of all heights

CODE	COLOR	LENGTH	SIZE	WIDTH
88241		81,5cm	S	6,5cm
88242		96x6,5cm	M	
88243		116cm	L	

Std Pack 60 Category D10

Loop Band

- > **Material:** 100% Natural Latex
- > **Length:** 104cm
- > **Thickness:** 4,5mm
- > **Maximum Elongation:** 500%
- > **Packaging:** Hangable nylon bag with head-card



CODE	COLOR	HARDNESS	WIDTH	RESISTANCE
				200%
88193		Ultra Light	0,63cm	5Kg
88194		Light	1,30cm	12Kg
88195		Medium	2,15cm	17Kg
88196		Heavy	3,15cm	26Kg
88197		Extra Heavy	4,45cm	33Kg
88198		Ultimate	5,20cm	52Kg

Std Pack 125 Category D10

Small Loop Band Set

- > **Material:** 100% Natural Latex
- > **Length:** 30cm
- > **Width:** 5cm
- > **Maximum Elongation:** 500%



Scan here and discover your first exercises with AMILA Small LoopBands

Std Pack 40 Category D10

SET 4x DIFFERENT RESISTANCES

4 Resistance Band Set, Exercise Leaflet and Carrying Pouch

AMILA® Physical Conditioning | Restoration | Strengthening
LOOPBAND



CODE	COLOR	HARDNESS	THICKNESS	RESISTANCE	
				200%	
96605		Light	0,6mm	4Kg	
		Medium	0,8mm	6Kg	
		Heavy	1,0mm	8Kg	
		Ultimate	1,2mm	10Kg	

Small Loop Band

- > **Material:** 100% Natural Latex
- > **Length:** 30cm
- > **Width:** 5cm
- > **Maximum Elongation:** 500%
- > **Packaging:** Hangable nylon bag with head-card



Std Pack 1000 Category D10

CODE	COLOR	HARDNESS	THICKNESS	RESISTANCE	
				200%	
96600		Ultra Light	0,4mm	2Kg	
96601		Light	0,6mm	4Kg	
96602		Medium	0,8mm	6Kg	
96603		Heavy	1,0mm	8Kg	
96604		Ultimate	1,2mm	10Kg	

Mini Band Set

- > **Material:** 100% Natural Rubber
- > **Length:** 30cm
- > **Width:** 5cm

LATEXFREE
100% NATURAL RUBBER



Std Pack 50 Κατηγορία Δ10

SET 4x DIFFERENT RESISTANCES

4 Resistance Band Set, Exercise Leaflet and Carrying Pouch

RUBBER LOOPBAND

CODE	COLOR	HARDNESS	THICKNESS	RESISTANCE	
				200%	
96617		Light	0,70mm	8,5Kg	
		Medium	1,00mm	9,0Kg	
		Heavy	1,15mm	10,2Kg	
		Ultimate	1,30mm	13,8Kg	

Exercise with Eleanna Lima

All **AMILA GymBand Sets** include a leaflet of exercises with **Eleanna Lima**, graduate of Physical Education and Sports (TEFAA) and Organization of Physical Activity and Sports Recreation (DPTH)



AMILA
Physical Condition | Rehabilitation | Strengthening

GYMBAND



No more training without data!

All AMILA GymBands have information about the dimensions, nominal resistance and range of strength required for the exercise.

GymBand Resistance Chart

The **linearity of resistance** is the most important quality criterion for a band.

AMILA GymBands are the most common training and recovery choice of professionals.

COLOR	HARDNESS	THICKNESS	RESISTANCE					
			200%	250%	300%	350%	400%	450%
Yellow	Ultra Light	0,2mm	2,70Kg	3,95Kg	5,25Kg	2,70Kg	3,95Kg	5,25Kg
Green	Light	0,3mm	3,58Kg	5,70Kg	7,40Kg	3,58Kg	5,70Kg	7,40Kg
Red	Medium	0,4mm	4,65Kg	6,90Kg	9,05Kg	4,65Kg	6,90Kg	9,05Kg
Blue	Heavy	0,5mm	8,00Kg	11,80Kg	15,65Kg	8,00Kg	11,80Kg	15,65Kg
Black	Ultimate	0,6mm	9,05Kg	13,60Kg	18,05Kg	9,05Kg	13,60Kg	18,05Kg

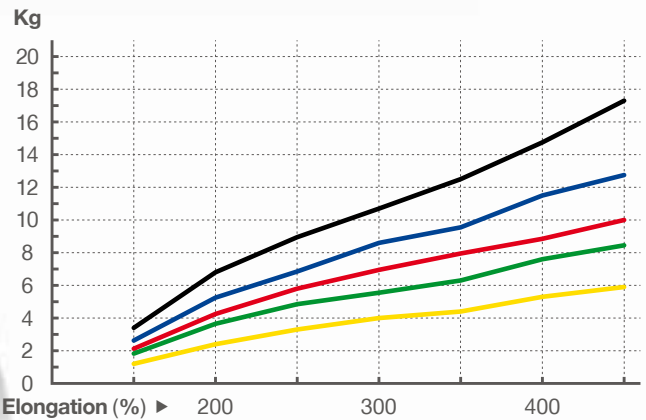

- > **Length:** 25m
- > **Width:** 14,5cm
- > **Material:** Latex
- > **Packaging:** Box



Gym Band Roll

CODE	COLOR	HARDNESS
48144	Yellow	Ultra Light
48145	Green	Light
48146	Red	Medium
48147	Blue	Heavy
48148	Black	Ultimate
48149	Grey	Ultimate+
48150	Gold	Ultimate++



> **Packaging:**
New nylon bag with head-card



> **Length:** 1,2m
> **Width:** 14,5cm
> **Material:** Latex
> **Packaging:** Nylon bag

Gym Band 1.2

CODE	COLOR	HARDNESS
48180	Yellow	Ultra Light
48181	Green	Light
48182	Red	Medium
48183	Blue	Heavy
48184	Black	Ultimate

Category D10

> **Packaging:**
New hangable box
Contains exercise leaflet



SET 3x DIFFERENT RESISTANCES
3 Resistance Band Set, Exercise Leaflet and Carrying Pouch

> **Length:** 1,2m
> **Width:** 14,5cm
> **Material:** Latex
> **Packaging:** Box

Gym Band 1.2 Set

CODE	COLOR	HARDNESS
48178	Green	Light
	Red	Medium
	Blue	Heavy

Category D10

> **Packaging:**
New nylon bag with head-card



> **Length:** 2,5m
> **Width:** 14,5cm
> **Material:** Latex
> **Packaging:** Nylon bag

Gym Band 2.5

CODE	COLOR	HARDNESS
48185	Yellow	Ultra Light
48186	Green	Light
48187	Red	Medium
48188	Blue	Heavy
48189	Black	Ultimate

Category D10

> **Packaging:**
New hangable box
Contains exercise leaflet



SET 3x DIFFERENT RESISTANCES
3 Resistance Band Set, Exercise Leaflet and Carrying Pouch

> **Length:** 2,5m
> **Width:** 14,5cm
> **Material:** Latex
> **Packaging:** Box

Gym Band 2.5 Set

CODE	COLOR	HARDNESS
48120	Green	Light
	Red	Medium
	Blue	Heavy

Category D10

AMILA®

Physical Condition | Rehabilitation | Strengthening

GYMTUBE

Work-out with
Christina
Pantazopoulou

All AMILA GymTubes with grip packages (Foam Grip and Gorilla Grip) include a leaflet (with accompanying video links) with training suggestions of the Physical Education and Sports Professor (Athens TEFAA) **Christina Pantazopoulou**.

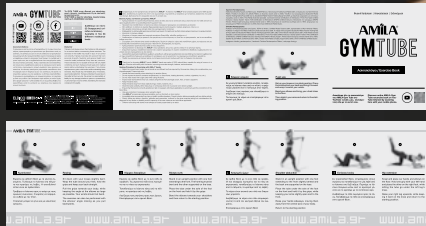

Double-Dipped Latex Tubing

AMILA GymTubes are double-dipped in Latex and are an excellent choice for fitness professionals. They are designed to offer unsurpassed performance and maximum durability.



GymTubes Resistance Chart

The **linear resistance** is the most important quality criterion for a tube.

AMILA GymTubes are the professional's basic training and recovery option.

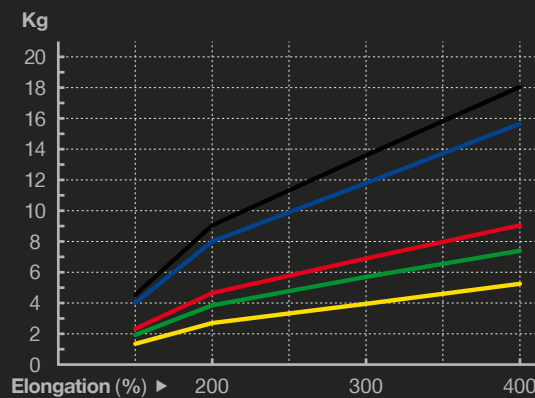

COLOR	HARDNESS	THICKNESS	RESISTANCE		
			200%	300%	400%
Yellow	Ultra Light	1,5mm	2,70Kg	3,95Kg	5,25Kg
Green	Light	2,0mm	3,58Kg	5,70Kg	7,40Kg
Red	Medium	2,5mm	4,65Kg	6,90Kg	9,05Kg
Blue	Heavy	3,0mm	8,00Kg	11,80Kg	15,65Kg
Black	Ultimate	3,5mm	9,05Kg	13,60Kg	18,05Kg



In collaboration with the **School of Health & Welfare Scientists**, for the program "Education and Therapeutic Exercise with the Application of the Clinical Pilates method" of the **Lifelong Learning Center** of the **University of West Attica**, ELDICO is in constant contact, making **AMILA** products available for the needs of the conducted programs and laboratory measurements, receiving important information on the development of the provided aids.



> **Packaging:**
New hangable box
Contains exercise leaflet

AMILA GorillaGrip

Gorilla Grip
Rubber grip made with custom mold



> **Length:** 140cm
> **Grip:** GorillaGrip
> **Grip (diameter):** 3,5cm
> **Grip (width):** 13cm
> **Strap (width):** 3,8cm

Gym Tube wGorillaGrip

CODE	COLOR	HARDNESS
96651	Yellow	Ultra Light
96652	Green	Light
96653	Red	Medium
96654	Blue	Heavy
96655	Black	Ultimate

Category D10



> **Packaging:**
New hangable box
Contains exercise leaflet

Foam Grip
Foam vinyl grip for comfort and to avoid sweating



> **Length:** 140cm
> **Grip:** Foam
> **Grip (diameter):** 3,0cm
> **Grip (width):** 12cm
> **Strap (width):** 2,9cm

Gym Tube wFoamGrip

CODE	COLOR	HARDNESS
48125	Yellow	Ultra Light
48126	Green	Light
48127	Red	Medium
48128	Blue	Heavy
48129	Black	Ultimate

Category D10

Multi Power Clip System

AMILA's Multi Power Clip System enables combined use with many tubes of the same or different resistance, which can be adjusted to different anchoring points, both on the body (see the pages with the accessories for bands with clips) as well as on a fixed point (base).



> **Packaging:**
New nylon bag with head-card

Reinforced Finish
Protects the links to prevent damage and corrosion

Sleeve
Protection of the tube for maximum durability

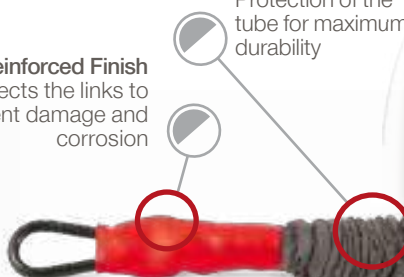

> **Length:** 140cm
> **Point:** Clip

Gym Tube wClip&Sleeve

CODE	COLOR	HARDNESS
88165	Yellow	Ultra Light
88166	Green	Light
88167	Red	Medium
88168	Blue	Heavy
88169	Black	Ultimate

Category D10

Multi Power Clip System

AMILA's Multi Power Clip System enables combined use with many tubes of the same or different resistance, which can be adjusted to different anchoring points, both on the body (see the pages with the accessories for bands with clips) as well as on a fixed point (base).



> **Packaging:**
New nylon bag with head-card

Reinforced Clip
Improved clip for increased resistance to strain



> **Length:** 140cm
> **Point:** Clip

Gym Tube wClip

CODE	COLOR	HARDNESS
88160	Yellow	Ultra Light
88161	Green	Light
88162	Red	Medium
88163	Blue	Heavy
88164	Black	Ultimate

Category D10

AMiLA® POWERGRIP

ONE ACCESSORY
MANY EXERCISES



96628

Power Grip

Λαβές Έλξεων - Πιέσεων

3 Distinct grips

ERGO GRIP



POWER GRIP



POWER+



SPECIFICATIONS

Material: TPR

Category: D10

88180

Gorilla Grip
for Gym Tubes with Clip

- > **Grip (diameter):** 3,5cm
- > **Grip (width):** 13cm
- > **Strap (width):** 3,8cm
- > **Packaging:** Hangable nylon bag with hang-tag

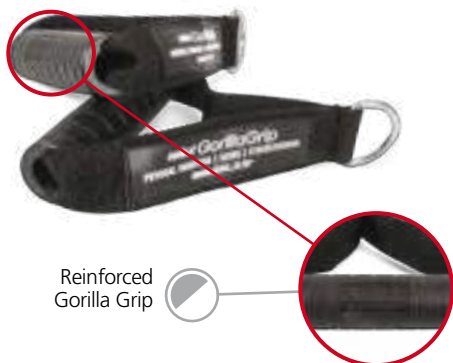

Reinforced
Gorilla Grip

88170

Foam Grip
for Gym Tubes with Clip

- > **Material:** PP
- > **Packaging:** Hangable nylon bag with hang-tag



PCS
2

Std Pack
70

Category
D10

PCS
2

Std Pack
100

Category
D10

96627

Ankle Cuffs
for Gym Tubes with Clip

- > **Strap (width):** 6,5cm
- > **Ring:** "D" shaped, double, 5,6mm thick



Reinforced Pillow from neoprene for maximum protection and soft feel

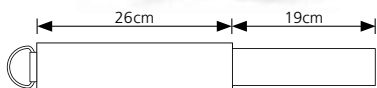

PCS 1 Category D10

96626

Ankle Cuffs
for Gym Tubes with Clip

- > **Strap (width):** 6,5cm
- > **Ring:** "D" shaped, single, 6,6mm thick



Reinforced Pillow from neoprene for maximum protection and soft feel

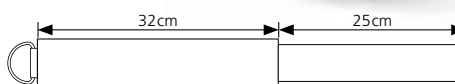

PCS 2 Category D10

48179

Wrist Cuff
for Gym Tubes with Clip

- > **Strap (width):** 6cm
- > **Ring:** "D" shaped
- > **Packaging:** Hangable nylon bag with hang-tag

Reinforced Pillow from neoprene for maximum protection and soft feel

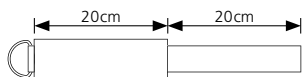

PCS 1 Std Pack 100 Category D10

88172

Ankle Cuffs
for Gym Tubes with Clip

- > **Strap (width):** 5cm
- > **Ring:** "O" shaped
- > **Packaging:** Hangable nylon bag with hang-tag

Reinforced Pillow from neoprene for maximum protection and soft feel

Tightening Ring for maximum grip

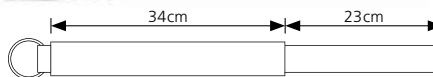

PCS 2 Std Pack 50 Category D10

88174

Door Fixing Hook
With strap for fastening tubes

- > **Strap length:** 22cm (folded)
- > **Packaging:** Hangable nylon bag with hang-tag



Neoprene Lining for maximum tube protection



PCS 1 Std Pack 100 Category D10

88173

Door Fixing Hook
With strap for fastening tubes

- > **Strap length:** 18cm (folded)
- > **Packaging:** Hangable nylon bag with hang-tag



PCS 1 Std Pack 100 Category D10

88181

Door Fixing Hook
With strap for fastening tubes

- > **Ring:** "O" shaped
- > **Strap length:** 42cm (ring included)
- > **Packaging:** Hangable nylon bag with hang-tag



PCS 1 Std Pack 100 Category D10

88182

Outdoor Mounting Hook
With strap for fastening tubes

- > **Ring:** "O" shaped
- > **Strap length:** 78cm (ring included)
- > **Packaging:** Hangable nylon bag with hang-tag



PCS 1 Std Pack 100 Category D10

- > Length: 25m
- > Inner Diameter: 6mm
- > Packaging: Box

Gym Tube Roll



CODE	COLOR	HARDNESS	DIAMETER
48171		Medium	10mm
48172		Ultimate	11mm
48173		Ultimate+	12mm

Std Pack 10 Category D10

- > Length: 110cm
- > Inner Diameter: 6mm
- > Packaging: Hangable blister

"8" Shaped Tube



CODE	COLOR	HARDNESS	THICKNESS
48151		Medium	10mm
48152		Ultimate	12mm

Std Pack 40 Category D10



- > Strap Width: 5cm
- > Ring: "D" shaped
- > Packaging: Nylon bag

Leg Training Set

With 3 levels of resistance

Smart Kit containing 2x Ankle Straps with 3x Resistance Tubes with Clips that can work in tandem increasing or decreasing the resistance level according to your needs. Lightweight and compact, ideal for workouts at home and while traveling.

CODE	COLOR	HARDNESS	RESISTANCE
			200%
88175		Medium	4,5Kg
88176		Heavy	6,5Kg
88178		Ultimate	8,5Kg
88179		Ultimate+	10,5Kg

Std Pack 50 Category D10

Build-In Construction
Two built-in comfortable, and adjustable ankle cuffs with velcro straps that stay in place whatever the exercise



- > Strap Width: 5cm
- > Packaging: Hangable nylon bag with hang-tag

Ankle Tube

Lightweight and compact, ideal for workouts at home and while traveling. Tones and strengthens hips and thighs through a complete range of movements. Its design allows for forward, backward, sideways and diagonal movement for functional fitness and balance.

CODE	COLOR	HARDNESS	RUBBER
48153		Medium	3,0mm
48154		Heavy	4,0mm
48155		Ultimate	5,0mm
48156		Ultimate+	6,0mm

Std Pack 50 Category D10

- > **Material:** Thick buffalo leather
- > **Filling:** Pressed cloth scraps

- + 2 big pieces of leather, sewn only on the side, design that gives more durability
- + Enhanced construction

Boxing Bag



Leather Category Z20

CODE	DIMENSIONS	WEIGHT
43844	120x35	42-44 Kg
43849	150x35	48-50 Kg

- > **Material:** PU + PVC with Pro Bubble Wall
- > **Filling:** Cotton

- **Pro Bubble Wall:** Special foam material inside for absorbing the blows and keeping the shape

Boxing Bag



Category Z20

CODE	DIMENSIONS	WEIGHT
43845	90x30	18-20 Kg
43846	100x30	28-30 Kg
43847	120x30	32-34 Kg
43848	150x35	38-40 Kg

- > **Material:** PU + PVC
- > **Filling:** Pressed cloth scraps

- **Pro Bubble Wall:** Special foam material inside for absorbing the blows and keeping the shape

Boxing Bag



Category Z20

CODE	DIMENSIONS	WEIGHT
43815	90x30	18-20 Kg
43816	100x30	23-25 Kg
43817	120x30	24-26 Kg
43818	150x35	28-30 Kg

43839

Boxing Bag

- > **Dimensions:** 120x35
- > **Weight:** 44kg
- > **Material:** PVC
- > **Filling:** Cloth scraps



Category Z20

43795

Boxing Bag

- > **Dimensions:** 105x33
- > **Weight:** Approximately 20kg (filled with sand)
- > **Material:** PVC



Category Z20

43796

Boxing Bag

- > **Dimensions:** 80x30
- > **Weight:** 18kg
- > **Material:** 840D Nylon Oxford
- > **Chain:** 5mm
- > **Ring:** 7mm



Category Z20

Pro Bubble Wall

Special foam material for absorbing blows

CODE	
43840001	
43841001	
43842001	
43843001	



Category Z20 > Material: PVC
> Sold empty

CODE		DIMENSIONS
43840		90x35
43841		120x35
43842		150x35
43843		180x35

Boxing Bag



• **Go Easy:** Very strong rip resistant but also soft material. A combination of polyester fiber woven on the outer material using various weaves.

Category Z20 > Material: Go Easy
> Sold empty

CODE		DIMENSIONS
43811		120x35
43812		150x35
43813		180x35

Boxing Bag



> **Material:** Black woven clip mesh pvc
> **Filling:** Renewable sponge + EPE + cloth

Boxing Bag



Category Z20

43794

> **Material:** Oxford fabric
> **Base:** Ø42x35cm filled with iron

- + Natural size
- + Competitive price
- + Very fast reset
- + High durability
- + Designed in the USA

CODE		DIMENSIONS	WEIGHT
96851		100x35	40 Kg
96852		125x35	50 Kg
96853		150x35	60 Kg

Weight 45kg

Category F1

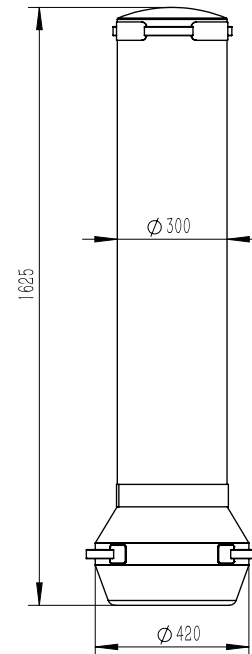

Free Punching

- + The **outer material** is resilient against punches, kicks, knees, and elbows
- + **Throw it on the floor** and easily practice other types of strikes
- + The **high weight** of the base brings it back to a standing position even after the hardest hit

+ Conveniently located **handles** on top and base allow for easy maneuverability.



Ø30x162cm

41984

- > **Base:** HDPE Ø800mm, 340mm height
- > **Pole:** Ø375mm PU covered
- > **Spring:** Steel
- > **Weight:** 145Kg



Category Z20

Boxing Dummy

37456

- Suitable for a bag weighting up to 80kg (depending on the hardness/durability of the concrete)



Category Z20

Boxing Bag Mount for the Ceiling

Fastened with 2 screws

Training Gloves



> **Material:** Leather

CODE	SIZE
43697	S

Leather

Category Z20



"Re-Born" Boxing Gloves

> **Material:** Leather

CODE	WEIGHT
37140	10 Oz
37141	12 Oz
37142	14 Oz
37143	16 Oz

Leather

Category Z20

- > **Length:** 3,0m
- > **Material:** Extra thick woven material
- > **Closure:** Velcro

Elastic Hand Wraps



CODE	COLOR
32040	Blue
32041	Black
32042	Red
32043	White

Length 3,0m

Category Z21



Easy Two-Step Folding and Transport Wheels



Adjustable Glideboard



Automatic Rail Locks and Hydraulic Rail Lift



Squat Stand



Retractable Dip Bars



LAT Bars

Molded Handles

6 Center Pulley Attachment Positions

WWW
TOTAL-GYM
.GR



46361

Category
F2

ENCOMPASS™ now part of our ELEVATE™ series and is the award-winning equipment anchor for GRAVITY®, the time-efficient, **personal training, group fitness and Pilates program** that is generating excitement and new revenue in commercial facilities around the world.

1. Adjustable glideboard promotes optimal spinal alignment and training variations.
2. Automatic rail locks allow for explosive plyometric jumping.
3. Hydraulic rail lift assists level changes and easy two-step folding.
4. Multiple center-pulley attachment positions double arm-cable load and increases lower extremity ROM.
5. LAT bars promote line-of-pull precision for arm-cable exercises.
6. Now comes with Retractable Dip Bars included on unit. Strength and Pilates Packages available for purchase. Individual accessories for purchase include: SCRUNCH®, Press Bar, Weight Bar, 3Grip Pull-up Bar, Dynamic Leg Pulley System, Telescoping Toe Bar, Leg Pulley System, Slide Distance Regulator and Standing Platform.

ENCOMPASS

DIMENSIONS	in-use: 2,7m × 1,0m × 1,8m folded: 0,5m × 1,0m × 1,4m
WEIGHT	81,65Kg
RAIL CONSTRUCTION	Steel reinforced extruded aluminium rails
RESISTANCE	1% to 62% of bodyweight
LEVELS	22 calibrated incline levels, with release lever to lock rails in place
SQUAT STAND	3 height levels
STORAGE	Hydraulic lift assists folding; rolls upright when folded
USER HEIGHT	2,1m (max)
CAPACITY	Total 295Kg (max) User 160Kg (max)
WARRANTY	Frame: 5 έτη Parts & Upholstery: 1 έτος Foam & Rubber: 90 μήνες

You can follow a **total-body workout** that combines more than 250 exercises, using the same machine, using only your body weight as resistance!

GRAVITY is for everyone, even for children, since it works using the body's weight and the difficulty level is adjusted according to the user.

Exactly this, **avoiding the use of any foreign powers** as resistance (bands, springs, weight etc.), along with the **huge range of motion and exercises**, gives you **complete control** and the **confidence** to even work on **injury rehabilitation** on each joint separately or all together.



GET A TOTAL BODY WORK

TOTAL GYM



STAND OUT

Competition is relentless

Don't use only the "well known"

Be innovative in your business

Focusing on strength, endurance, mobility and stability, you can create a complete circuit training program for personal or group use, even incorporating the equipment available in your studio or gym.

Get the whole ELEVATE series and setup your own circuit training course like no other.



ELEVATE ROW ADJ

Emulates a rowing movement pattern using 7 levels of adjustable bodyweight resistance. Produces a full-body workout, integrating a strength component into a fully adjustable cardio machine.

ELEVATE CORE ADJ

Strengthens the abdominals while engaging the entire core musculature. Offering unparalleled versatility for an abdominal machine, the Adjustable Core is a plank facilitator that allows for two primary movements, the Dynamic Plank and the SCRUNCH.

ELEVATE ENCOMPASS

Encompass is now part of our ELEVATE series and is the award-winning equipment anchor for GRAVITY®, the time efficient, personal training, group fitness and Pilates program that is generating excitement and new revenue in commercial facilities around the world.

A ROWING MACHINE LIKE NO OTHER

Strength Component + Super Cardio Machine

Be relentless with your demands for the best training experience

Scan the QR code, enter the YouTube Channel of TotalGym and learn of the exercises you can do with ELEVATE Row - Adjustable



TotalGym® continues to innovate with the ELEVATE™ line. A sleek matte black finish, combined with a full adjustable incline, transforms a functional training machine to something that will truly **upgrade** your business and will allow you to create **innovative** programs.

TOTAL GYM

Rediscover rowing

There is no other rower with incline in the market.

The exercise experience cannot be compared with any other traditional machine.

The entertainment level remains high until the end of the exercise and the effectiveness is truly unmatched.

We challenge you to observe the face of a user and only then will you understand what we mean!

Incline Release Lever to move between seven levels of resistance.



Monitor displays rowing time, split time (minutes per 500 meters), strokes per minute, total distance and total calories burned.



Instructional Placard provides at-a-glance exercises. **QR code** and **URL** provides smart phone links to **exercise videos**.



Anchor Feet with Bolt Holes for safety and stability.



Ergonomically Designed Seat designed for comfort and to encourage proper form.

Transport wheels



Improved Handle Design Shipping with New Units (not pictured above) features ergonomic grips at both ends providing control and comfort throughout movements.



46364

Category
F2

Row Adjustable

DIMENSIONS	2,5m × 0,83m × 1,06m [1,1 s.m. of floor space]
WEIGHT	48Kg
CONSTRUCTION	Steel with steel reinforced extruded aluminum rails
RESISTANCE	7 levels of incline
TRANSPORT	Integrated transport wheels
INSTALLATION	Designed to be bolted to the floor
WARRANTY	frame: 5 years moving parts & upholstery: 1 year rubber & foam material: 90 days

An ingeniously unique rower that emulates a rowing movement pattern using adjustable bodyweight resistance, the **ELEVATE Adjustable Row™** produces a full body workout, integrating a strength component into a fully adjustable cardio machine.

The **ELEVATE Adjustable Row™** targets all the muscles groups simultaneously and enables a smooth consistent load through the entire range of motion, due to loaded concentric and eccentric phases of the exercise.

- Upgrade on previous design:** User can choose between seven levels of resistance which uses a percentage of bodyweight. Note that this version *does not fold*.
- Adjustable incline body resistance integrates strength with cardio.
- Smooth consistent load through concentric and eccentric phases.
- Built for multi-planar movement.
- Low impact compression on the joints.



Learn everything about TotalGym and GTS



Adjustable glideboard



LAT bars



2018 INNOVATIVE PRODUCT AWARD

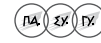

Integrated folding and transport wheels

COME OUT A WINNER

EXERCISE, FOLD & FREE THE ROOM AGAIN, AT THE SAME SPEED IT TOOK TO READ THIS!



Squat Stand (βάση για Βαθύ Κάθισμα)



Rail locks and hydraulic lift assist



Multiple center-pulley attachment positions

46359

Category F2

GTS

DIMENSIONS	in-use: 2,7m × 1,0m × 1,8m folded: 0,5m × 1,0m × 1,4m
WEIGHT	81,65Kg
RAIL CONSTRUCTION	Steel reinforced extruded aluminium rails
RESISTANCE	1% up to 62% of body weight
LEVELS	22 incline levels, with safety locking mechanism
SQUAT STAND	3 height levels
FOLD	Hydraulic assistance with transport wheels. Rolls upright
USER WEIGHT	2,1m (max)
CAPACITY	total 295Kg (max) user 160Kg (max)
GUARANTEE	frame: 5 years moving parts & upholstery: 1 year rubber & foam material: 90 days

The **TOTALGYM® GTS™** is the award-winning equipment anchor for **GRAVITY®**, the time-efficient, personal training, group fitness and Pilates program that is generating excitement and new revenue in commercial facilities around the world.

1. Adjustable glideboard promotes optimal spinal alignment and training variations.
2. Automatic rail locks allow for explosive plyometric jumping.
3. Hydraulic rail lift assists level changes and easy two-step folding.
4. Multiple center-pulley attachment positions double arm-cable load and increase lower extremity ROM.
5. LAT bars promote line-of-pull specificity for arm-cable exercises.
6. Includes workout DVD and exercise wall chart.
7. Most popular accessories include **SCRUNCH®**, Press Bar, Retractable Dip Bars, Weight Bar, 3Grip Pull-up Bar, Dynamic Leg Pulley System, Toe Bar for Pilates.

Benefits for the Trainee:

- Effective full body workout producing fast results.
- Definition – Activates the abdominal and back muscles in every exercise.
- Increases strength and endurance.
- Improves balance.
- Weight loss and measurements decrease, improving Body Mass Index.
- Increases metabolism.
- Improves the functional performance of daily activities.
- Offers cardio-endurance during high resistance training.
- Zero impact, safe, with full back support.

Applications and Industrial:

- Partial loading of Closed Kinetic Chain joints.
- Exercises in three basic levels and multi-level movement (3D).
- Adjustment of the cable-pulley power angles according to the dimensions of the trainee, his perimeter and exercise aim.
- Trains stabilisers and proprioception to improve position, speed and direction of the body parts.
- Specialised exercises energising movement.
- Explosive upper and lower limb plyometric training.
- Full-body support, friendly to the joints, which does not create compression.
- More than 250 exercises and variations.
- Advanced Pilates for bot training and education.
- Reliable tool for assessing lower body strength.
- Full range of educational DVDs (and on-line) available.



46373

Category F2

Jump Trainer

DIMENSIONS	2,6m × 0,8m × 1,7m [2,2 s.m. of floor space]
WEIGHT	105Kg
RAIL CONSTRUCTION	Steel reinforced extruded aluminium rails
RESISTANCE	For Physical Therapy: 30%-65% of body weight For Exercising: 50%-80% of body weight
BANDS	4,5-32Kg added adjustable resistance in 4,5Kg steps
USER WEIGHT	180Kg (max)
TRANSPORT	Integrated transport wheels
INSTALLATION	Designed to be bolted to the floor
GUARANTEE	frame: 5 years moving parts & upholstery: 1 year rubber & foam material: 90 days

The exceptional safety levels, its innovative features and resistance variability that **Jump Trainer** offers

make it **usable by users with any physical condition** and to be **recommended even for physiotherapy!**

The **TOTALGYM® JUMP TRAINER™** builds **explosive power** and develops **muscle mass** on the lower part of the body with to main moves, **squat** and **squat jump**.

- It stands out for its unique design which facilitates as no other machine the plyometric exercises, fully utilizing the linear resistance of body weight and the variable resistance from the tubes. Four zones with bands can be used to offer resistance from 4,5 to 32Kg in 4,5Kg steps.
- **JUMP TRAINER™** produces both concentric and eccentric muscle loading, allowing users to quickly accelerate and decelerate during a squat jump with a secure, controlled manner and the help of the pneumatic break that guarantees protection of the joints.
- Supports the spine so that users can easily control the phases of traditional exercises, while at the same time offering the ability for more inventive variations to be created.
- The excellent security levels allows it to be used by trainees regardless their fitness level and to be recommended even for physiotherapy.

TWO LEVELS OF RESISTANCE

Physiotherapy and Fitness, each allows for seven incline levels, ranging from 30 to 80% of the user's body weight.

COME OUT
A WINNER

EXERCISE, FOLD
& FREE THE
ROOM AGAIN,
AT THE SAME
SPEED IT TOOK
TO READ THIS!

Adjustable glideboard
angle with automatic
locking



Seven central pulley
hooking positions



Adjustable
grips



Folding
support
grips



Grips with
integrated
remote control

Removable
Squat Stand

Integrated
folding and
transport
wheels

Hydraulic
assistance



46365

Category
F2

Examples of
Rehabilitation
Exercises



Power Tower

DIMENSIONS	in-use: 2,7m × 1,0m × 2,0m folded: 0,5m × 1,0m × 1,7m
WEIGHT	99Kg
RAIL CONSTRUCTION	Steel reinforced extruded aluminium rails
RESISTANCE	1% to 72% of body weight
GRADUATIONS	26 calibrated levels of incline, with infinite adjustments between levels
SQUAT STAND	3 height settings
FOLDING	Hydraulic assistance with transport wheels. Rolls upright
USER HEIGHT	2,1m (max)
CAPACITY	total 295Kg (max) user 160Kg (max)
GUARANTEE	frame: 5 years moving parts & upholstery: 1 year rubber & foam materials: 90 days

21 MILLIONS
psychotherapy
patients per
month in 14.000
clinics

Functional training with incline using TOTALGYM® equipment provides the optimal experience, recruiting multiple muscle groups in tandem and make exercising more productive.

Total Gym delivers exceptional results on every level, serving more than 15 million people every year with the awarded design and functionality of its products.

WHY INCLINE;

- Partial loading of the joints
- Excellent feel of control and balance
- Unlimited range of motion
- Works on the three basic levels, plus multi-level movement (3D)
- Increases the position, speed and direction of body parts and helps the brain to guide the movements
- Trains the stabilisers
- Explosive plyometric training of upper and lower limbs
- Full-body support, joint friendly (non-compressive)
- More than 250 strength exercises and variations
- Advanced Pilates training
- Reliable tool for assessing lower-body strength
- Specialised increase in endurance and toughness, kinetics of sports included.

SPEED-UP RECOVERY

BECOME THE BEST

Don't stick to the old methods

Achieve quick restoration

Take smart advantage of your space

RESEARCH PROVES TOTAL GYM MACHINES —COMPONENT OF THE GRAVITY SYSTEM— ARE THE MOST RELIABLE TO PERFORM MEASUREMENTS OF PERFORMANCE AFTER AN INJURY RECOVERY PERIOD

In the past there were few options available for injury rehabilitation specialists and fitness instructors to measure lower extremity performance in individuals with limited weight bearing capacity.

In the past, specialists had to rely on hands-on muscle tests (often imprecise) to determine endurance and functional performance in a patient recovering from a lower extremity injury.

So there was a need to create an accurate measurement to track the patient's progress, which would happen earlier, during the recovery process.

The University of San Diego (School of Physical Education and Nutritional Sciences) and the University of Toledo (Health Science) conducted a study to measure the reliability and validity of the Total Gym as a coherent tool to measure leg strength. The results of the study were published in the North American Journal of Sports Physical Therapy in May 2009. **The research found out that measuring leg performance using Total Gym's instruments provides significant results regarding a patient's current functional status -earlier- in the rehabilitation and recovery process. The tests performed provided reliable data to detect the patient's condition, such as functional improvement, presentation of change or loss of patient performance.**

Thus, Total Gym equipment evolved from exercise equipment for patient rehabilitation to measurement tools to provide valid information on a patient's progress toward full weight-bearing function. Since, according to the results, the trainees felt that they could - really - put in more effort with TotalGym, since they were not afraid of falling or injuring themselves.

TotalGym® specializes in functional bodyweight training equipment that allows clinicians to build injury-specific treatment and training that can **accelerate patient outcomes.**

PowerTower™ maintains a therapeutic profile that enhances performance possibilities and offers the flexibility to meet the demands of rehabilitation.

46363

- Provides dedicated area for planking
- Rolling glideboard offers option to increase instability
- Ability to progress or regress exercises by changing body position
- Offers 7 levels of resistance
- Designed to be bolted to gym floor
- Integrated transport wheels

SCRUNCH Forearm Pad features an ergonomic grip bar for stabilization and a high-density foam cushion with box-stitched vinyl upholstery

Exercise Placard with QR code to exercise videos

Rolling Padded Glideboard allows for multiple progression options

Rubber Foot Plate for safety and comfort

Incline Release Lever



Floor Anchor Bolt Holes



Core Trainer

Range of Motion: 787mm

Rails: Steel reinforced extruded aluminum rails

Weight: 40Kg

Max User Weight: 181Kg

- Warranty: Frame - 5 years, Rubber & Moving Parts - 1 year, Upholstery - 90 days;

180x83x129cm

Category F2

46374

- XLow compression on the joints, especially the lower spine
- Full leg and shoulder strengthening
- The resistance incline can be raised or lowered to adapt to all needs
- Designed to adapt to all body sizes
- Integrated transport wheels

Exercise Computer



Exercise placard



Egonomically Designed Seat



Row Trainer

Counter: Time, minutes/500m, pull-ups/min, distance, calories

Rails: Steel reinforced extruded aluminum rails

Weight: 44,5Kg

Max User Weight: 181Kg

- Warranty: Frame - 5 years, Rubber & Moving Parts - 1 year

250x60x80cm

Category F2

46372

- Unique closed chain design reduces shoulder impingement and stabilizes the shoulder girdle
- Inverted position unloads the lower back and reduces spinal compression
- Ability to progress exercises by adding plyometric movement
- Seven levels of resistance
- Designed to be bolted to gym floor.
- Integrated transport wheels

Press Trainer

Resistance: 15% to 50% of bodyweight

Range of Motion: 840mm

Rails: Steel reinforced extruded aluminum rails

Weight: 53Kg

Max User Weight: 181Kg

- Warranty: Frame - 5 years, Rubber & Moving Parts - 1 year, Upholstery - 90 days;



170×100×100cm

Category
F2

46371

- Adjustable incline design allows for partial bodyweight pull-ups.
- Ability to progress exercises by adding plyometric movement
- Offers four basic hand grip positions
- Designed to be bolted to gym floor.
- Integrated transport wheels

Pull-up Trainer

Resistance: 30% to 60% of bodyweight

Range of Motion: 840mm

Rails: Steel reinforced extruded aluminum rails

Weight: 55Kg

Max User Weight: 181Kg

- Warranty: Frame - 5 years, Rubber & Moving Parts - 1 year, Upholstery - 90 days;



180×110×110cm

Category
F2

46370

- 15" Step-Up/Box Jump platform
- Designed to be bolted to gym floor.
- Integrated transport wheels

Leg Trainer

Range of Motion: 565mm

Rails: Steel reinforced extruded aluminum rails

Weight: 54Kg

Max User Weight: 181Kg

- Warranty: Frame - 5 years, Rubber & Moving Parts - 1 year



150×60×40cm

Category
F2

46350

Leg Pulley System



Category
F2

46351

Pull-up Bar



Category
F2

46352

Press Bar



Category
F2

46353

Scrunch



Category
F2

46354

Telescopic Toebar



Category
F2

46356

Standing Platform



Category
F2

46357

Weight Bar



Category
F2

46358

Squat Handlebar



Category
F2

TOTAL GYM

STAND OUT

Competition is relentless

Don't use only the "well known"

Be innovative in your business

ERGONOMICS & SAFETY

TOTALGYM® design benefits both the fitness instructor and the trainee. As the user trains in an inclined position, does not have to bear all of his weight. Thus, the pressure on the joints is minimized, both for beginners and those with special injury issues and need to be taken care of. In addition, the space

required by the **ENCOMPASS™** line and the **GTS™** can be minimized so that it will not take space in the room. After completing the exercises, they fold and stored at a corner, not needing more space than half s.m., leaving the space free for other exercises or functions in your business or home.

No other single instrument is supported with such a wide range of information.



Be an Innovator

Only if you pursue your business will you stay strong.

Only if you constantly pursue the best can you evolve.

Only if you innovate can you stand out.



Είμαστε παθιασμένοι με την πεποίθηση ότι το να διατηρείσαι fit μπορεί να σου προσφέρει μια ευτυχέστερη και υγιέστερη ζωή. Ο στόχος μας είναι να αναπτύξουμε εξατομικευμένες εμπειρίες υγείας και φυσικής κατάστασης που θα βοηθήσουν τους ανθρώπους να ζήσουν τις ζωές που επιθυμούν.

Πάνω από είκοσι χρόνια προσπαθούμε να εξελίξουμε τη γυμναστική με έμφαση στην εργονομία, επαναπροσδιορίζοντας συνεχώς τα επίπεδα καινοτομίας και ποιότητας, με στόχο τη βελτίωση της προσωπικής ευεξίας.

AMILA® Renegade

Μάθε τα πάντα για τη σειρά AMILA Renegade μέσα από το πλήρως ενημερωμένο site: amila-air.gr

Δεν πρόκειται για μια συνηθισμένη σειρά AIR!

Τα Renegade συμμετέχουν στα σημαντικότερα CrossFit Events και δεν είναι τυχαίο που συγκαταλέγονται ανάμεσα στα καλύτερα του κόσμου.

LOW-IMPACT, TOTAL-BODY WORKOUT

Η σειρά AMILA Renegade δίνει τη δυνατότητα στον ασκούμενο να αναλάβει δράση για την τέλεια προετοιμασία και την απόλυτη καύση των θερμίδων του **χωρίς καμία επώδυνη πρόσκρουση στις αρθρώσεις**. Ιδανικά τόσο για την προθέρμανση, πριν την προπόνηση, όσο και για την απόλυτη προετοιμασία.

ΚΟΥΡΦΑΙΑ ΥΛΙΚΑ

Τα Renegade είναι κατασκευασμένα για να νικούν. Οι **βαρέως τύπου διπλές λεπίδες** των καλύβδινων πτερυγίων, τα **διπλά σφραγισμένα ρουλεμάν επαγγελματικής χρήσης**, τα **πολλαπλής κατεύθυνσης έδρανα** και οι **βιομηχανικοί ιμάντες κίνησης Poly-V** εγγυώνται τα δυο σημαντικότερα χαρακτηριστικά της σειράς: **Διάρκεια και Αντοχή**.

ΑΠΕΙΡΗ ΕΝΤΑΣΗ & ΑΝΤΙΣΤΑΣΗ

Σε αντίθεση με τους άλλους τύπους οργάνων γυμναστικής, τα προϊόντα αέρα παρέχουν το πλεονέκτημα της **απεριόριστης αντίστασης στην αιολική ενέργεια**, προσαρμοσμένο για κάθε επίπεδο προπόνησης.

ΕΞΑΙΡΕΤΙΚΟ ΕΡΓΑΛΕΙΟ ΑΠΟΚΑΤΑΣΤΑΣΗΣ

Είναι εξαιρετικά εργαλεία για την αποκατάσταση, καθώς παρέχουν **ασφαλή κίνηση χωρίς καμία επίδραση**. Επιπλέον, διευκολύνουν την **αιμάτωση της περιοχής τραυματισμού** βοηθώντας με αυτόν τον τρόπο στην ταχύτερη αποκατάσταση.

HIGH INTENSITY INTERVAL TRAINING (HIIT)

Τα όργανα γυμναστικής με φυσική αντίσταση είναι **τα απόλυτα εργαλεία της διαλειμματικής προπόνησης (HIIT)**.

ΨΥΞΗ

Τα AMILA Air Bike (Ποδήλατο) & Air Rower (Κωπηλατική) παρέχουν στους ασκούμενους ένα **δροσιστικό κύμα αέρα**, κατά την εκτέλεση της προπόνησης, μέσω του ανεμιστήρα αντίστασης που διαθέτουν στο εμπρός μέρος.

amila-air.gr

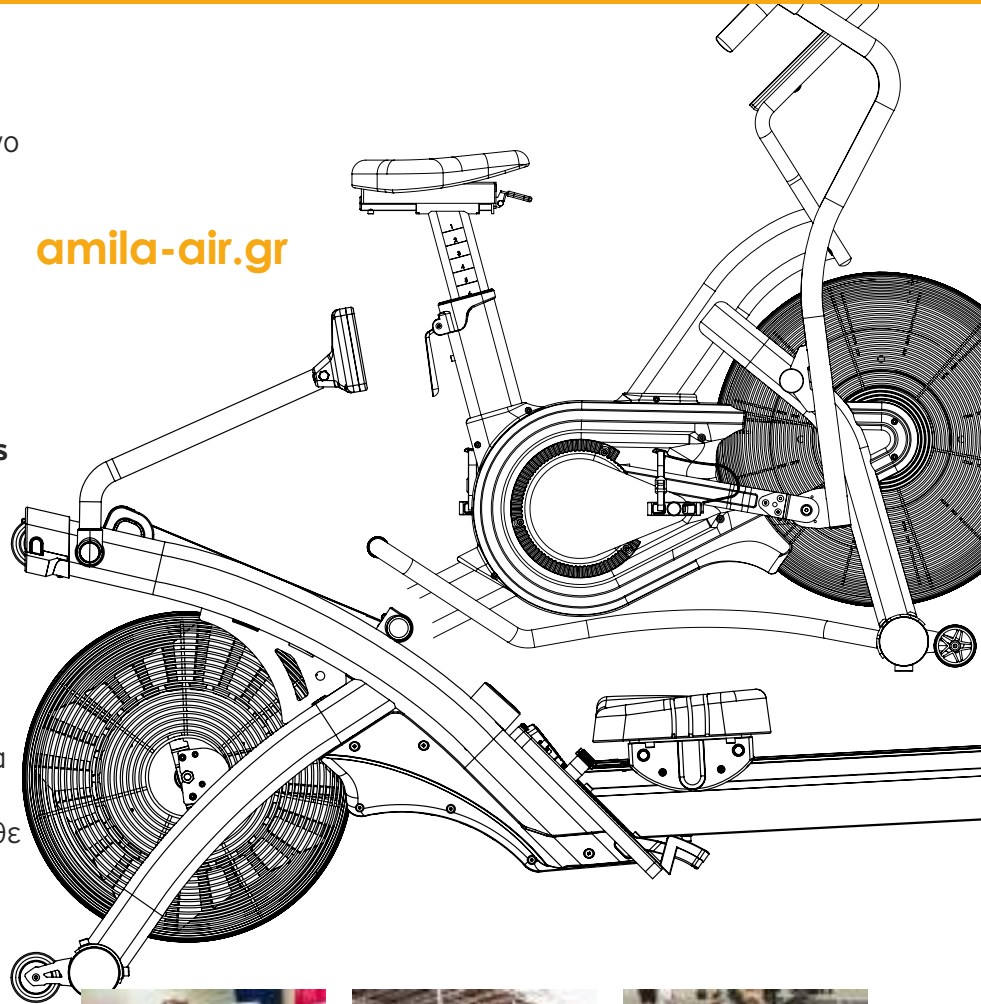

93810

Air Mag Rower

Ergonomic Handles,
2 pairs for different
exercises

POLAR
COMPATIBLE



Smooth, natural,
unlimited airflow/
magnetic resistance
from a heavy-duty
45cm aluminum fan

Large LCD Screen
with wireless heart receiver.

SPECIFICATIONS

- Dimensions: 62,0x20,0x75,0 cm
- Console: LCD back-light
- Readings: Time, Stroke, Stroke/min, Distance, Calories, Time/500m, Watts, Heart rate
- Programs: 8 (20/10, 20/30, custom intervals, 4 x target settings and H.R.C.)
- Resistance: Magnetic, 14 levels
- MAX user weight: 150 kg
- NET weight: 27,5 kg
- Category: F2

3 distinct mounts

Combine the Air Ski with one of the three mounts, according to your needs.

93807

Wall Mount
Fixed



SPECIFICATIONS

- Dimensions: 29,0x7,0x44,0 cm
- Material: Steel 4mm thick
- NET weight: 5 kg
- Category: F2

93808

Wall Mount
Adjustable



Quick release locking
system to place
the main unit in
desired position and
orientation

SPECIFICATIONS

- Dimensions: 49,0x37,0x229,0 cm
- Material: Steel 2mm thick
- NET weight: 52 kg
- Category: F2

93809

Platform
Adjustable



SPECIFICATIONS

- Dimensions: 60,0x128,0x207,0 cm
- Material: Steel 2,3mm thick
- NET weight: 83,5 kg
- Category: F2

TECHNOLOGY

Large LCD screen with a wireless receiver displays all workout data in easy to read format

Tracks time, stroke, stroke per minute, distance, calories, time per 500 meters, watts, and heart rate

Target, interval and heart rate programs



SCAN HERE
Assembly Video on
our YouTube channels.

COMFORT

Ergonomic handles (2 pairs for different exercises)

Smooth, natural, unlimited airflow/magnetic resistance

Lightweight, low maintenance, high-strength drive cords for smooth feel and long life

Infinitely design Stainless Steel quick exchangeable mechanism design for vertical & horizontal grip handles used for different exercises requirements

CONSTRUCTION

Super internal drive mechanism with robust FC 2016 sealed cartridge one-way bearing and also 6203 sealed cartridge bearing inserted to offer best performance for both double-pole and classic (alternating arms) technique, minimal maintenance required

Self-levelling pulley system with robust 6200 sealed cartridge bearings inserted and got width between 62cm / 24.4" (max.) to 26cm / 10.2" (min.)

Heavy-duty 45cm aluminum fan with cross-bonded steel blades for the ultimate in linear power

93805

POLAR
COMPATIBLE

Runner R1
NON-FOLDING

Supperb Rehabilitation Machine

Safe movement with no negative effects



SPECIFICATIONS

Dimensions: 188,0x86,0x158,0 cm

Running Surface: 48,0x160,0cm

NET weight: 152 kg

MAX user weight: 150kg

Guarantee: 2 years

Category: F2



TECHNOLOGY

Non-electric treadmill, driven exclusively by the user

Console readings: Time, Distance, Calories, Speed, Watt, RPM of the deck, Heart Rate (optional)

Heart rate measurement with (optional) wireless belt

Power measurement in watt, an accurate measurement to check your progress and improvement

COMFORT

Manually controled 4 level resistance

NO maximum speed

NO waiting when changing speed

Most natural running experience, which relieves tension on the joints

The rubber surface absorbs the harmful for the joints vibrations

CONSTRUCTION

Heavy duty dual anti-slip cast rubber molded slats, with heavy-duty 608zz sealed bearings for proper control of the surface trajectory control

Steel handle on the back for ease of transport

Ergonomic 38mm diameter grips

Anti-slip adjustable leveling feet for ease and stability

93806

POLAR
COMPATIBLE

HIIT Runner
NON-FOLDING

**A treadmill like
no other...**

Natural resistance exercise machines are the ultimate interval training tools



2 bottle holders

Oval steel frame
40x120mm

Integrated 75mm
casters made of nylon
fibers for easy transport

Big LCD screen, with 8 programs
and heart rate receiver

4 resistance
levels

Ergonomic grips
38mm diameter

Slats from special
PU covered DuPont
composite

Anti-slip adjustable
leveling
feet for increased stability

Steel handle
for easy
portability

SPECIFICATIONS

Dimensions: 171,0x168,0x99,0 cm

Running Surface: 48,0x160,0 cm

NET weight: 135 Kg

MAX user weight: 150 Kg

Guarantee: 2 years

Category: F2

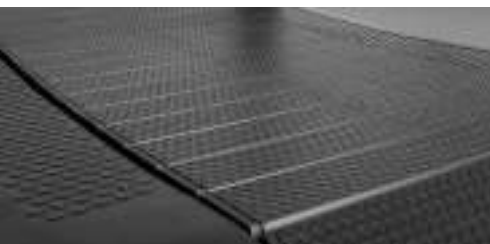

TECHNOLOGY

Non-electric treadmill, driven exclusively by the user

Console readings: Time, Distance, Calories, Speed, Watt, RPM of the deck, Heart Rate (optional)

Heart rate measurement with (optional) wireless belt

Power measurement in watt, an accurate measurement to check your progress and improvement

COMFORT

Manually controlled 4 level resistance

NO maximum speed

NO waiting when changing speed

Most natural running experience, which relieves tension on the joints

The rubber surface absorbs the harmful for the joints vibrations

CONSTRUCTION

Heavy duty dual anti-slip cast rubber molded slats, with heavy-duty 608zz sealed bearings for proper control of the surface trajectory control

Steel handle on the back for ease of transport

Ergonomic 38mm diameter grips

Anti-slip adjustable leveling feet for ease and stability

93800

POLAR
COMPATIBLE

Air Rower

Not an ordinary AIR series!

ReNegaDE machines participate in the most important CrossFit Events and it is no coincidence that they are among the best in the world.

Large LCD screen displays 8 workout modes including 20/30, 20/10, custom intervals, target settings and SPM control



Engineering chromed pulley with robust 608zz sealed cartridge bearings



8 resistance levels



Quick adjust footrests



Engineering POM rollers with robust 608zz sealed cartridge bearings



Smooth, natural, unlimited airflow/magnetic resistance from a heavy-duty 37cm aluminum fan



Anti-slip adjustable footstops for more stability



Nylon fiber integrated OD 74mm moving wheels with 6200 sealed cartridge bearing for easy transportation



SPECIFICATIONS

Dimensions: 218,0x61,5x76,0 cm

NET weight: 49,5 Kg

Gross weight: 58 Kg

MAX user weight: 150 Kg

Frame warranty: Lifetime

Other parts: 2 years

Wear parts: 6 months

Category: F2



TECHNOLOGY

Large LCD screen with a wireless receiver displays all workout data in easy to read format

Tracks time, distance, calories, watts, strokes, SPM and time/500

Target and interval programs

Tracks pulse via optional chest belt

COMFORT

Ergonomic handle with high tensile strength nylon pulling strap

Oversized footplates with adjustable straps to get strong support

The air rower has a comfortable, padded, upholstered seat

Nylon fiber integrated wheels and folding mechanism for easier storage

A fantastic adjustable air resistance that continues to challenge you in your exercise

Also supplied with all tools and step by step instructions for easy home assembly

CONSTRUCTION

Engineering chromed pulley with robust 608zz sealed cartridge bearings

SQ 370mm 2.8kg super steel fan

Steel reinforced aluminium track

Engineering POM rollers with robust 608zz sealed cartridge bearings

Thick dual handles with black foam grip

93801

POLAR
COMPATIBLE

38mm diameter, 3mm thick moving arms are built to take the most intense upper body workouts

Air Bike Pro

Linear Increase of Intensity and Resistance

In contrast with other types of exercise machines, the ones using air as resistance have the advantage of infinite resistance, suitable for every training level.

Large moulded PU seat for extra comfort, infinitely adjustable quick release saddle adjustment



Performance monitor with 8 workouts modes and wireless heart rate receiver

Oversized foot pegs

Main framework constructed from 3mm thick steel for maximum strength

Smooth, natural, unlimited airflow resistance provided by a heavy-duty 56cm steel fan with cross-bonded steel blades for the ultimate in linear power

Handle with knurled grip to easily pick up and move it around

Anti-slip adjustable footstops for more stability

Industrial grade, sealed cartridge bearings on all moving joints for long lasting durability and smooth and quiet action

SPECIFICATIONS

- Dimensions: 123,0x142,0x76,5 cm
- NET weight: 76,5 Kg
- Gross weight: 81 Kg
- MAX user weight: 130 Kg
- Warranty: 2 years
- Category: F2

Low maintenance, endless Poly-V single belt transmission

10 mm Thick SS41 engineering steel crank arm for superb strength & durability

Nylon fiber integrated moving wheels for easy transportation



TECHNOLOGY

- Large LCD screen with a wireless receiver displays all workout data in easy to read format
- Tracks time, distance, calories, watts, strokes, SPM and time/500
- Target and interval programs
- Tracks pulse via optional chest belt

COMFORT

- Ergonomic handle with high tensile strength nylon pulling strap
- Oversized footplates with adjustable straps to get strong support
- The air rower has a comfortable, padded, upholstered seat
- Nylon fiber integrated wheels and folding mechanism for easier storage
- A fantastic adjustable air resistance that continue challenges you in your exercise
- Also supplied with all tools and step by step instructions for easy home assembly

CONSTRUCTION

- Engineering chromed pulley with robust 608zz sealed cartridge bearings
- SQ 370mm 2.8kg super steel fan
- Steel reinforced aluminium track
- Engineering POM rollers with robust 608zz sealed cartridge bearings
- Thick dual handles with black foam grip

93811



Easy-to-use quick mode buttons with simple control keypad, LCD displays all important information

A comfortable molded seat allows users to work out for longer stretches with maximum enjoyment

Not only allows up and down seat adjustment, but also features a fore/aft adjustment for the perfect fit

Standard, integrated windscreen to prevent blowback for user comfort

Air-driven resistance delivers a simultaneous upper and lower-body challenge allowing the user to emphasize pushing and pulling or experience a total-body workout



Built with extra-heavy-gauge steel tubing to give it a stable base, uses high-quality bearings rather than bushings to ensure a longer life and smoother cycling action

Air Bike AB900 SPIRIT

Standard Integrated Windscreen, Built-in Transportation Wheels

Console: LCD 13x6,5cm, powered by 4xAA batteries

Readings: RPM, Speed, Time, Distance, Calories, Watt, Pulse, Interval prompt

Programs: Target Time, Target Distance, Target Calories, Target HR, Interval 20-10, Interval 10-20, Interval Custom, Manual

Frame: Commercial-grade structural steel with durable powder-coat paint

Flywheel: 27" fan housing with 9 steel blades

Seat: High-density foam racing saddle

Foot Pedals: Large platform, Molded traction pins

Resistance: Unlimited (Air/Based on Fan Speed)

Transmission: Chain, Dual Action, Direct Drive

Weight: 54Kg

Max User Weight: 160Kg

Heart rate: Polar

122x64x127cm

Category
F2

43359

The **CRW800+ Rower** combines a long list of high-performance features with a **reliable design**. From the convenience of the **508mm frame height** and **folding storage design** to the combined **air/magnetic resistance** and **remote handle controls**, the CRW800+ is sure to impress.

It is the perfect addition to a corporate fitness/recreation center, school or hotel because the ease of use and resulting unparalleled full-body workout are second to none.



Wireless remote handle controls allow quick changes to resistance



Flex pedals with easy-adjust numbered settings

Solid steel frame with aluminium monorail



Commercial grade handle strap is both smooth and reliable

Durable stainless steel fan cover

Fold-up frame design for easy storage

CRW800+ Rower SPiRiT

Console: LCD 140mm, with adjustable arm and angle, needs 2xC batteries (not included)

Readings: Time, strokes/min, level, distance, calories, watts, pulse

Resistance: Air and magnetic (16 levels)

Flywheel: Ø200mm, 3,5kg

Monorail: 1372mm length

Programs: Manual, Distance, Time, Calories, 20/10 Interval, 10/20 Interval, Custom Interval, Fat Burn, Cardio, Strength, Game

Footrests: Flex pedals with numbered settings

Seat: Contoured and padded

Frame: High-strength steel with durable powder-coated paint, aluminum monorail

Weight: 43,5Kg

Max User Weight: 205Kg

Heart rate: Polar

Folded: 135×46×180cm

239×46×96,5cm

Category F2

HSR007

SKI & ROW Multiple Training Machine MARS (Magnetic & Air Resistance System) adds a further resistance to the



air resistance. The innovation perfectly solves the problem of no resistance involved at the start position of training, enables users to change the equipment mode from cardiovascular to power training.

air resistance. The innovation perfectly solves the problem of no resistance involved at the start position of training,

The MARS system has 20 precise resistance levels. Through the console, users can easily adjust the resistance at all times.



The TPR made skiing handles provide a more comfortable grab feeling.

Thanks to the innovative design, the folded (1,10sq.m.) machine saves 48% space comparing with the rowing (2,12sq.m.) form. Therefore, the SKI & ROW Multiple Training Machine is also suitable for a small fitness studio or residential use.



Built-in compatible telemetric heart rate: device helps users to monitor intensity of the workout. The exercise data can be easily synchronized to Wahoo and other third-party Apps via Bluetooth or ANT+. An adjustable console makes it easy to fit better towards user's eyesight and makes it easy to reach from a comfortable position.



Solid and compact, the specially designed SKI & ROW Multiple Training Machine makes it easy to change from vertical form to horizontal form by simply stepping on the switching pedal. The two-stage air lock system and folding lock-up system ensure safety in daily using condition.



The optional foot straps are ideal for users to train lower body.



HSR007 Ski & Row

- Console:** LCD 7", adjustable angle, 8 readout windows (needs 4x C batteries)
- Readings:** Time, Stroke rate, Pace, Distance, Watts, Calories, Heart rate, Level
- Resistance:** Air and magnetic (20 levels), power 300W
- Flywheel:** 4,2kg
- Monorail:** Aluminum, length 1663mm
- Programs:** 5 (Time/distance/calorie target, Interval time/distance)
- Seat:** Contoured, height from ground 51,3cm
- Weight:** 66,5Kg
- Max User Weight:** 150Kg
- Heart rate:** Polar

Folded: 136×88×214cm

292×88×105cm

Max User Weight	Category
150 Kg	F2

HBO05 Ultra Air Bike

HBO05



5" LCD console, powered by 4 C cell batteries, with 10 built-in workout modes, including 4 custom HIIT training modes.

Synchronized motion of pedals and handle bars

The workout data can be synchronized to your smart devices via Bluetooth or ANT+. Then you can track the data with 3rd party applications which manage your training more scientifically. It helps users make a more reasonable training plan.



Heart Rate Monitor compatible with Polar heart rate belt

The resistance is delivered by the 26" fan, which is driven by power and speed of the pedals along with the two handles that move back and forth. The users are able to determine the intensity level and the resistance.

Consider electropolished steel gets rust easily, the seat support and pedals of ULTRA BIKE are made of aluminum alloy, which is less prone to corrosion, helping provide long service life.

The 26 ABS curved blades, molded into one piece, which makes it stabilized and more quiet than traditional steel blades.



The PU foamed ergonomic seat provides a smooth output and comfortable ride.



Compared to an ordinary air bike with its chain that always sways and bumps and needs scheduled maintenance, Ultra bike's V-Belt drive provides smooth and consistent ride without extra maintenance and high cost.



Console	LCD 5"
Console Readings	Time, Speed / Average speed, Calories / Average calories, Distance, RPM / Average RPM, Watt / Average Watt, Heart rate / Average Heart rate
Programs	3 Target programs (time, distance, calories), 3 Heart Rate programs (65%, 75% & 85%) and 4 Interval programs (3 time interval and 1 distance interval)
Other Specs	Transport wheels, Cup holder

128x71x133cm

Weight
80 Kg

Max User Weight
150 Kg

Category
F2

CT850

Category F2

44866



TAIWAN

CT800

Category F2

44859



USA
TAIWAN

Motor	4.00 hp AC (8 hp peak)	3.00 hp AC (6 hp peak)
Console	Big LED Matrix screen with 3 additional LED information windows, separate LED 20 character message window and LED heart-rate bar, Speed and Incline buttons, Heart rate sensors	Big LED Matrix screen with 4 additional LED information windows, separate LED 20 character message window and LED heart-rate bar, Speed and Incline buttons, Heart rate sensors
Console Readings	Time, Speed, Distance, Heart rate, Calories, Incline, Tempo, METs	Time, Speed, Distance, Heart rate, Calories, Incline, Tempo, METs
Programs	9 predefined + 1 manual + 2 user + 2 HRC	6 predefined + 1 manual + 2 HRC + custom
Speed	0,8-20 Km/h	0,8-20 Km/h
Incline	Electronic 15 levels	Electronic 15 levels
Deck	Shock resistant 25mm, waxed, does NOT need lubrication	Shock resistant 25mm, waxed, does NOT need lubrication
Belt	56x152,5 cm	56x152 cm
Rollers	—	Front 75mm, rear 75mm - SKF bearings
Dimensions (open)	212,5x88,4x147 cm	214x89x145 cm
Weight	180Kg	165Kg
Max User Weight	150 Kg	150 Kg
Other Specs	Transport wheels, Bottle holder, Book holder, Fan	Transport wheels, Bottle holder, Book holder, 2 Fans

NON-FOLDING

SPiRiT

Semi-Commercial Grade

- 4hp motor (better than CT800's)
- Supperb and tested Inverter
- Hevy duty construction
- Bigger dimensions
- Can be used in a regular gym as an auxiliary treadmill



CE

Semi-Commercial Grade

SPiRiT



CE



43334



Semi-Commercial Grade



Step length can be adjusted from 46cm to 61cm, electronically adjustable with a button on the right handle.



CE

Category F2

213×82×177cm

CE 850 SPiRiT

Computer: Blue Dot Matrix, 20 character message window, heart-rate bar graph, one-touch program selection, fan, tablet stand, tray

Readings: Time, Distance, Calories, Speed, Reps/min, Watt, Heart rate

Programs: 5 predefined + 1 manual + 2 user + 2 HRC

Resistance: 20 levels (electronically adjusted)

Frame: Steel powdercoated

Disk: 13.5 Kgr

Pedals: Big size, 5 cm apart, 2 degree inversion, placing the user in an anatomically correct position

Grips: Adjustable in many positions, resistance and step buttons

Weight: 120Kg

Step: 457-609mm

Max User Weight: 150Kg

Heart rate: Touch and with optional heart-rate belt

43394



Semi-Commercial Grade



CE

Category F2

198×63,5×178cm

CE 800+ SPiRiT GENERATOR

Computer: Large multi LED windows, 18 character message center, track and profile window, adjustable fan angle, tablet stand, bottle and accessory holder, USB charging port

Readings: Time (elapsed and remaining), Distance, Calories, Speed, Reps, Watt, Heart rate, Level, METs, Track, Profile

Programs: 5 predefined + Manual + Custom + HRC + Fitness test + Constant power, METs

Resistance: 40 levels (electronically adjusted)

Frame: Steel powdercoated

Disk: 14 Kgr

Stride: 50,8mm

Pedals: Big size, 2 degree inversion, placing the user in an anatomically correct position

Weight: 110Kg

Max User Weight: 205Kg

Heart rate: Touch and with optional heart-rate belt

43328



Semi-Commercial Grade



CE 800 SPIRIT GENERATOR

- Computer:** Large Blue Dot Matrix with 20-character Led message center, LED heart rate bar, tablet friendly reading rack, one-touch program selection, 7 buttons for start, stop/reset, enter, up, down, display. Turbo cooling fan
- Readings:** Time, Distance, Calories, Speed, RPM, Watt, Heart rate
- Programs:** 5 predefined + 1 manual + 1 user + 1 fitness + 1 HRC + 1 constant power
- Resistance:** 40 levels (electronically adjusted)
- Disk:** Ø245mm, 13.5 Kgr
- Pedals:** Oversized with 2-degree inversion
- Gear ratio:** 01:09,4
- Pulley:** Nylon + 15% fiberglass Ø330mm
- Crank:** 2 pc, Ø255mm
- Weight:** 109Kg
- Step:** 51cm
- Max User Weight:** 200Kg
- Heart rate:** Touch and with optional hear-rate belt



CE

198x70x170cm

Category F2

43324



Commercial Grade



SE 800 SPIRIT

- Magnetic Adjustable Resistance utilising Neodimium magnets**
- Heavy duty iron frame with high quality paintjob**
- Handbrake**
- Computer:** 4 LED screens, time select and start/stop
- Readings:** Time, Distance, Speed, RPM, Heart rate
- Disk:** Ø450mm, 14 Kgr
- Gear ratio:** 01:08,4
- Pulley:** Iron Ø174mm
- Crank:** 2 pcs., Ø255mm
- Weight:** 112Kg
- Step:** 51cm
- Max User Weight:** 150Kg
- Heart rate:** With optional hear-rate belt



Big pedaws with special anti-skid design



Handbrake for more security



Adjustable handgrips. Resistance adjuster. Bottle holders.



Patented transmision system

173.7x59.8x166.4cm

Category F2

43357



Semi-Commercial Grade



CE

Category F2

140x81x160cm

CS 800 SPIRIT

Computer: Blue LED, 20 character message window, heart-rate bar graph, one-touch program selection, fan, tablet stand, tray

Readings: Time, Distance, Calories, Speed, Reps/min, Watt, Heart rate

Programs: 5 predefined + 1 manual + 2 user + 2 HRC

Resistance: 20 levels (electronically adjusted)

Frame: Steel powdercoated

Disk: 10 Kgr

Pedals: Big size, 5 cm apart, 2 degree inversion, placing the user in an anatomically correct position

Weight: 79Kg

Max Step Height: 40,5cm

Max User Weight: 204Kg

Heart rate: Touch and with optional heart-rate belt

43366



Semi-Commercial Grade



CE

Category F2

151x74x129cm

CR 800+ SPIRIT GENERATOR

Computer: Large multi LED windows, 18 character message center, track and profile window, adjustable fan angle, tablet stand, bottle and accessory holder, USB charging port

Programs: 5 predefined + Manual + Custom + 2 HRC + Fitness test + Constant power

Disk: 14 Kgr

Resistance: 40 levels (electronically adjusted)

Drive train: Poly-V belt with self-tensioner

Frame: Steel powdercoated

Seat: 14 positions, aluminum rail

Pedals: Oversized with fast-latching adjustable strap system

Weight: 74Kg

Max User Weight: 205Kg

Heart rate: Touch and with optional heart-rate belt

43327



Semi-Commercial Grade



CU800 SPIRIT GENERATOR

- Computer:** Dot Matrix with 20 Led, one-touch program selection, 6 buttons for start, stop/reset, enter, up, down, display. Fan
- Readings:** Time, Distance, Calories, Speed, RPM, Watt, Heart rate
- Programs:** 5 predefined + 1 manual + 1 user + 1 fitness + 2 HRC
- Disk:** 13,60 Kgr, bearings made in Japan
- Resistance:** 40 levels (electronically adjusted)
- Max User Weight:** 150Kg
- Weight:** 52Kg
- Heart rate:** Touch



Category F2

108x55x136cm

43352



Commercial Grade

+ Saddle and handlebar posts from stainless steel

Robust (OB-35A) AMILA

Ideal for group sessions.
Infinite adjustments for saddle/handlebar.
Belt drive. Transport wheels.
Emergency brake.

- Resistance:** Hand regulated, break on the top side
- Frame:** Steel, anti-rust coated
- Saddle:** Microadjustable, front/back & up/down
- Handlebars:** Microadjustable, front/back & up/down, Double
- Pedals:** SPD double
- Transmission:** 6 groove belt
- Disk:** 24kg CNC Steel
- Bearings:** Sealed
- Axle:** 25mm
- Crank:** 30B, 170mm
- Weight:** 58,3kg
- Ratio:** 1:3
- Max user weight:** 150Kg



SCAN HERE to view the Assembly Video on our YouTube channel.



Category F2

140x65x130cm

43337

 TAIWAN

Commercial Grade

+ Seat and grip's masts made of stainless steel

Indoor Cycle AMILA®

Ideal for group sessions.
Infinite seat/grip adjustments.
Transport wheels.

- Resistance:** Hand regulated, break on the top side
- Grips:** Adjustable Up-Down, Front-Back
- Seat:** Adjustable Up-Down, Front-Back
- Drive:** Chain
- Bearings:** Sealed
- Axle:** 25mm
- Crank:** 30B, 170mm
- Disk:** 20Kgr
- Weight:** 50,5kg
- Ratio:** 1:3

Max user weight: 130Kg



128x64x134cm

Category F2

PS300

 CHINA

Commercial Grade



Side brake, allowing you to adjust the resistance more smoothly and evenly

Spline fit axis, which has better loosening prevention function



PS300DZB

The console is optional, corresponding to the code above

PS300 inimpulse

Bottle holder, Transport wheels, Emergency brake

- Computer:** Wireless LCD (optional component)
- Readings:** Rotation, Heart rate, Calories, Speed
- Transmission:** Chain
- Pedals:** SPD double-sided
- Seat:** Microadjustable
- Grips:** Rubber coated
- Disk:** 20kg
- Weight:** 58Kg

Max User Weight: 150Kg

120x53x111cm

RoHS  

Category F2

CT800+

Category F2

44801



RT750

Category F2

RT750



Motor	3.00 hp AC (5.50 hp peak)
Console	7 white LED windows, Speed and Incline buttons, Heart rate sensors
Console Readings	Time (elapsed and remaining), Distance, Heart rate, Calories, Speed, Incline, Pace, Track, Watt, METs
Programs	7 + 2 HRC + 6 fitness tests + custom + manual
Speed	0.8-20 Km/h
Incline	Electronic 15 levels, 0.5 increments
Deck	Maintenance-free, 25mm, double-sided
Belt	56x152,5 cm Habasit
Rollers	75mm
Dimensions (open)	215,9x90,9x153,9cm
Weight	173Kg
Max User Weight	205 Kg
Other Specs	Fan, Phone/tablet holder, Bottle holder, USB charging, Accessory tray, Polar

Motor	5.00 hp AC (7.50 hp peak)
Console	16x32 Dot Matrix + 7 Led Windows, Single-key program selection, Numeric keypad, Speed and Incline buttons on the hand-grips , Heart-rate sensors
Console Readings	Time, Remaining time (%), Distance, Calories, Calories/hour, Speed, Average Speed, Incline, Steps, Pace, Heart rate, Heart rate (%), Time in target zone
Programs	6
Speed	0.6-25 Km/h
Incline	Electronic 0-15%
Deck	Reversible 2,54 cm, does not need lubrication
Belt	56x152 cm, 21,6 cm over the ground, Habasit prewaxed, 3,3mm
Rollers	Front 89mm, Rear 75mm
Dimensions (open)	208x95x159 cm
Weight	207Kg
Max User Weight	180 Kg
Other Specs	Cell/I-pad stand, Fan, Transport wheels, 2 bottle holders, Book stand, Polar

SPiRiT

NON-FOLDING

Semi-Commercial Grade

USAGE WITH PHONE

+ Bluetooth FTMS 4.0

- Motor protected against overheating and peak overload
- Power control board with cooling system
- Polar compatible
- Deck: DK Ultimate Deck (manufacturer by D&P, USA) with increased service life, the standard of comfort, reliability and durability

WARANTEE

1 year for commercial use



- Belt: Commercial, multi-layer Habasit (Switzerland), one of the strongest and most durable cloths in the world; Two rubber layers for durability, a PVC layer to prevent excessive stretching and a nylon fabric layer for good sliding on the deck



in

impulse

NON-FOLDING

Commercial Grade

- **Inverter:** Delta
- **Suspension:** Pulflexx
- **Maintenance:** Not needed for approximately 40,000 km.

+ Speed & Incline buttons on the hand-grips

WARANTEE

1 year for commercial use



	TA-7715	Category F2	44780	TAIWAN	AC2990	Category F2	AC2990	CHINA
Motor	3.00 hp AC (6 hp peak)				AC 3.00 hp (4.50hp peak)			
Console	Dot Matrix LED 21x10 + 6 Windows, Speed and Incline buttons, Heart rate sensors				Dot Matrix 8x16, 6 LED windows, Speed and Incline buttons, Heart rate sensors			
Console Readings	Time, Speed, Distance, Heart rate, Calories, Incline				Time, Avg. Speed, Heart rate, Distance, Steps, Calories, Cal/Hour, Speed, Incline			
Programs	4 predefined + 1 manual + 1 user + 1 HRC				3 target + 5 preset + manual + 2 user + 3 HRC			
Speed	0.8-25 Km/h				1-20 Km/h			
Incline	Electronic 0%-15%				Ηλεκτρική, 0%-15%			
Deck	Shock resistant laminated double sided MDF with melamine 25,4mm, with absorbent antivibration elastomers on the bottom				Reversible, 25mm thick			
Belt	56x158 cm, thickness 3,3mm, PVC 4 layers				Siegling, 56x152 cm, 2.3mm thick			
Rollers	Front 89mm, Rear 89mm				Front 76,5mm, Rear 76,5mm			
Dimensions (open)	218x100x150 cm				220x92x156 cm			
Weight	219Kg				170Kg			
Max User Weight	180 Kg				150 Kg			
Other Specs	Transport wheels, Bottle holder, Book holder, Handrail of double injection PVC				Phone holder, 2 bottle holders, Transport wheels			

AMILA®

NON-FOLDING

Commercial Grade



- Hybrid suspension for smooth shock absorption and to prevent from injury during the exercise

WARANTEE
1 year for commercial use



inimpulse

NON-FOLDING

Commercial Grade



WARANTEE
1 year for commercial use



RE700



CHINA

Commercial Grade



RE700 **in impulse**

Transport wheels, Bottle holder, Towel hanger

Computer: Dot Matrix + 6 Windows, Single-press program selection, Numeric keypad

Readings: Time, Distance, Calories, Resistance, Steps, Heart rate

Programs: 12 predefined

Frame: 2 layers of paint over anti-rust layer

Resistance: 25 levels (electronically adjusted)

Brake: Self-powered hybrid break, 350W resistance

Step: 53cm

Handgrips: Movable: Ergonomic, Εργονομικές, multi-position, dual energy
Stable: Ergonomic, with heart rate sensors and function control

Pedals: With gel pillows, distanced at 2,54 cm, 19 cm from the ground

Weight: 118Kg

Max User Weight: 160Kg

Heart rate: Polar & Touch



CE

218x74x161cm

Category F2

43780



TAIWAN

Commercial Grade



EG 8520 **AMILA** GENERATOR

Transport wheels, 2-stage transmission with Poly-V belt

Computer: LCD back-lit with adjustable tilt, Bottle holder

Readings: Time, Distance, Rotations/minute, Speed, Level, Calories, Heart rate, Watt

Programs: 12 predefined + 1 manual + 1 user + 4 HRC

Disk: 10 Kgr

Gear ratio: 1:15,2

Resistance: 16 levels (electronically controlled by level and watt)

Brake: Self-powered hybrid break, 30~300W/60rpm resistance

Step: 58,5cm without rollers, elliptical trajectory, incredibly silent and natural movement

Grips: Movable: Dual energy coated with high density foam
Fixed: With heart-rate sensors

Movement: Forward and backward

Pedals: Big size, anti-slip with pads

Weight: 130Kg

Max user weight: 180Kg

Heart rate: Polar & Touch



CE

230x68x160cm

Category F2

43369



Commercial Grade



CE

Category F2

170×74×125cm

CR 900 SPIRIT GENERATOR

Transport wheels, 42mm bearings, 3 speed fan, Book/tablet rack, Shelf
Computer: LED backlight, 18 character message window, laps, hear-rate bar graph, separate screens for reps and level, keypad, bottle holder

Programs: 7 + 1 manual + 2 HRC

Disk: 14 Kgr

Bearings: IKO, NACHI, INA/SKF

Resistance: 40 levels

Gear ratio: 9.5:1

Frame: Steel powdercoated

Console: Corestar

Seat: Infinite adjustments

Pedals: Big, weighted

Weight: 88Kg

Max User Weight: 160Kg

Heart rate: Polar & Touch

RR700



CHINA

Commercial Grade



CE

Category F2

165×64×138cm

RR700 in impulse

Bottle holder, Transport wheels

Computer: Dot Matrix + 6 Windows, program selection with the press of a button, Numeric keypad

Readings: Time, Distance, Watt, Speed, Calories, Heart rate

Programs: 7

Frame: 2 layers of paint over anti-rust layer

Grips: Ergonomic, with hear-rate sensors and function control

Resistance: 25 levels (electronically adjusted)

Brake: Self-powered hybrid brake, 450W resistance

Crank: Oversized

Pedals: Oversized double-sided with straps

Max User Weight: 180Kg

Weight: 83Kg

Heart rate: Polar & Touch

RR500

CHINA

Semi-Commercial Grade



RR500 *impulse*

Bottle holder, Transport wheels

Computer: Dot Matrix + 7 Windows, program selection with the press of a button, Numeric keypad

Readings: Time, Distance, Watt, Speed, Calories, RPM, Heart rate

Programs: 11

Frame: 2 layers of paint over anti-rust layer

Grips: Ergonomic, with hear-rate sensors and function control

Resistance: 20 levels (electronically adjusted)

Brake: Self-powered hybrid brake, 300W resistance

Crank: Standard

Pedals: Single-sided weighted

Max User Weight: 160Kg

Weight: 79Kg

Heart rate: Polar & Touch

CE

165×65×140cm

Category F2

RU700

CHINA

Commercial Grade



RU700 *impulse*

Bottle holder, Transport wheels

Computer: Dot Matrix + 6 Windows, single-press program selection

Readings: Time, Distance, Calories, Speed, Incline, Steps, Heart rate

Programs: 7 predefined

Frame: 2 layers of paint over anti-rust layer

Grips: 3-position adjustable, with heart-rate sensors and function buttons

Resistance: 25 levels (electronically adjusted)

Brake: Self-powered hybrid brake, 450W resistance

Crank: Oversized

Pedals: Oversized double-sided with straps

Max User Weight: 180Kg

Weight: 67Kg

Heart rate: Polar & Touch

CE

109×60×149cm

Category F2

43781

 TAIWAN

Commercial Grade



CE

121×68×142cm

Category F2

UG 8020 AMILA® GENERATOR

Transport wheels, 2-stage transmission with Poly-V belt

Computer: LCD back-lit with adjustable tilt, Bottle holder

Readings: Time, Distance, Rotations/minute, Speed, Level, Calories, Heart rate, Watt

Programs: 12 predefined + 1 manual + 1 user + 4 HRC

Disk: 10 Kgr

Resistance: 16 levels (electronically adjusted by Level and Watt)

Brake: Self-powered hybrid break, 40~350W/60rpm resistance

Gear ratio: 1:12,3

Seat: Easily adjusted height due to the neumatic suspension

Pedals: With adjustable straps

Crank: 3 pcs hidden

Grips: Ergonomic, with adjustable armrest pads

Weight: 70,8Kg

Max User Weight: 180Kg

Heart rate: Polar & Touch

RU500

 CHINA

Semi-Commercial Grade



CE

109×66×149cm

Category F2

RU500 *in*impulse

Bottle holder, Transport wheels

Computer: Dot Matrix + 7 Windows, single-press program selection

Readings: Time, Distance, Calories, Speed, Incline, Steps, Heart rate

Programs: 11 predefined

Frame: 2 layers of paint over anti-rust layer

Hand-grips: 3-position adjustable, with heart-rate sensors and function buttons

Resistance: 20 levels (electronically adjusted)

Brake: Self-powered hybrid brake, 300W resistance

Crank: Standard

Pedals: Single-sided weighted

Max User Weight: 160Kg

Weight: 68Kg

Heart rate: Standard & Touch

3D DESIGN

ECDESIGN



ECONOMY | INNOVATION | DEVELOPMENT

Save cost and time by reducing the interventions that arise after completing the project.

Visualise your gym complete and perform a virtual walk through it using a video tour, even before the first crew begins working!

3D design is not a fad or just one more technology. It is the evolution in construction.



Our team expands. The sales consultants, in collaboration with the permanent specialized new-technologies team of the company, now offer a package consisting of selecting, designing and photorealistically visualising, that can work individually or in tandem with the architect's plans.

We at EΛΔΙΚΟ integrated a comprehensive program of services including consulting design, to create a functional professional environment and 3D visualizations of the space, according to the need to be served and the unique aesthetic that suit you.



We integrate the floor-plan in collaboration with the architect



We configure the gym according to your needs, maximizing its functionality



We turn drawings to 3D presentations



We export the list of the selected machines to a file

91550

AMiLA® 45° Leg Press

- > **Tube:** 100x50x3.0mm oval
- > **Seat wood:** 18mm thick
- > **Seat pad:** 65mm thick
- > **Back pad:** 65mm thick



Weight **244kg** Category **F2**

240x1150x140cm

91552

AMiLA® Hip Thrust

- > **Tube:** 100x50x3.0mm oval
- > **Seat wood:** 18mm thick
- > **Seat pad:** 65mm thick
- > **Back pad:** 65mm thick



SCAN HERE 
to view the Assembly
Video on our YouTube
channel.



Weight **172kg** Category **F2**

185x153x120cm

HSP-PRO-001

HSP-PRO-001

The 5 LED windows design can accurately display the resistance level, training times (2 windows), peak power percentage and parameters, which is convenient for the user to always grasp the training information to scientifically arrange the training plan



> **Cable:** 2,2m x Ø3,2mm

Air Resistance Dual-Arm Functional Trainer

Equipped with double training arms, the cable joint end can rotate 360° with the change of force direction of the trainer, ensuring the comfort of the strength exertion and variable force direction need during the training process. Meanwhile, it can protect the cable and extend its service life

It can also expand with a variety of accessories to cooperate with various special functional trainings, such as dual pull handle, ankle strap, training bat, training belt, thigh strap, tricep training rope, etc



Through easy-to-understand training guidelines, users can quickly master the training methods of major muscle groups



Depending on the height and movement of the trainer, the training arm can be adjusted in coronal plane (up/down) of 180° and at 13 gears. Unilateral horizontal level of both arms (front/rear) 90°, 7 gears adjustment, which is suitable for all heights and training types

Can be fixed to the wall

Resistance **2-25kg** Increment **0,1kg** Weight **150kg** Category **F2**

216x150x164cm

94470

> **Dimensions:** 1 x 1 m,
1,5cm thick

Category
F2



Upper surface



Lower surface



Lower connector

Upper connector

> **Connectivity:** Can be securely connected either as a big surface using connectors at the corners, or many pieces in a straight line using connectors only on the sides.

Rubber floor



Lower connector



Upper connector

Connection at the corners,
using four (4) pieces of flooring



Without lower connector



Lower connector in place

Connection at the side,
reverse side of the flooring, two (2) pieces of flooring

9447001

> **Dimensions:** 0,5x0,2 m,
1,5cm thick

> Slanted side to protect
the flooring's edges

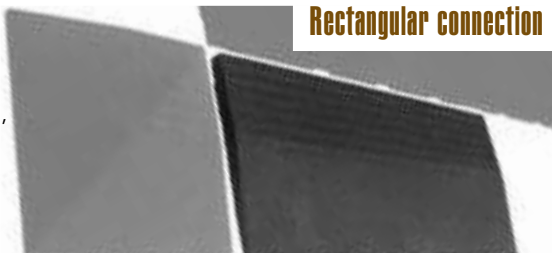

Rectangular connection

9447002

> **Dimensions:** 0,2x0,2 m,
1,5cm thick

> Slanted corner to protect
the flooring's edges

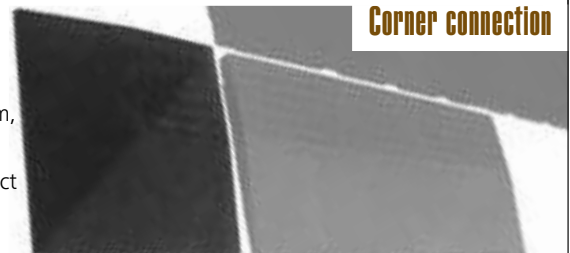

Corner connection

94472

> **Dots:** Gray

+ The gray dots are like EPDM and help disguise footprints

+ Expected service life 4-7 years

• Choice between blue, light-blue and yellow dots

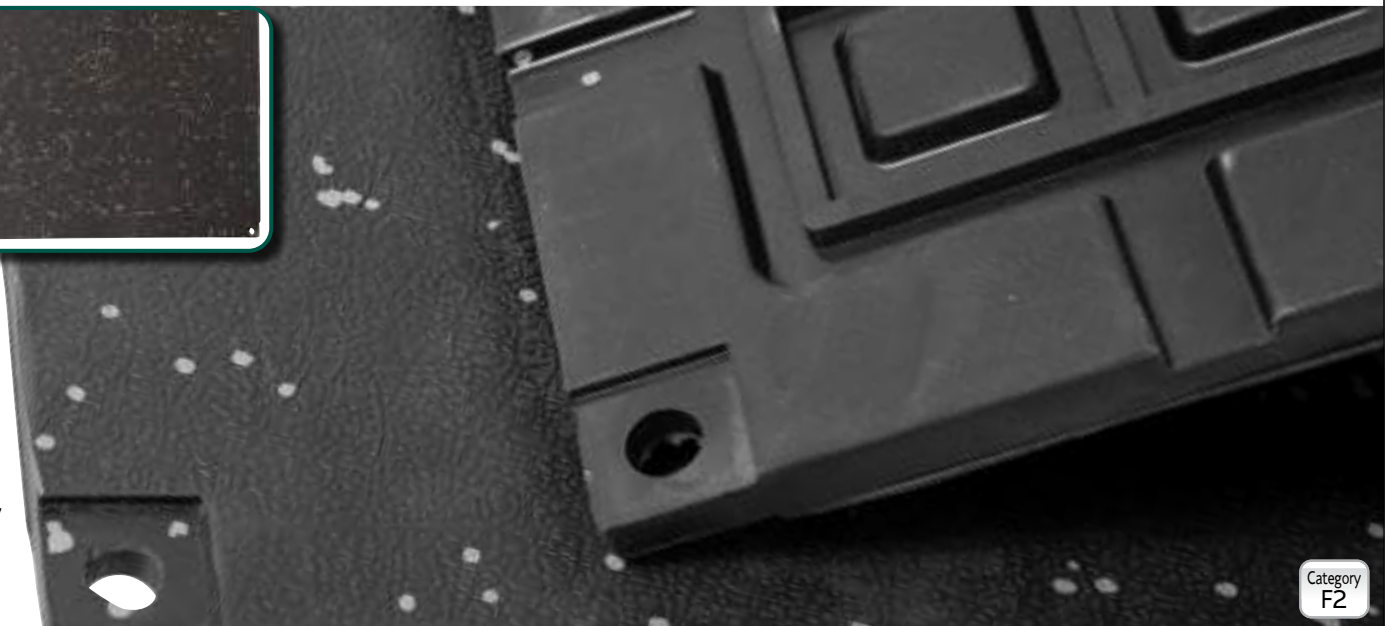

Category
F2

Wall Stickers

Protects, insulates and beautifies the wall

- + Made of environmentally friendly, non-toxic material, absolutely safe for children.
- + Waterproof, easing the cleaning process.
- + It can be placed on almost any type of surface, as long as it is smooth (e.g. wood, plastic, metal, tile, glass, wallpaper), since it is equipped with a strong adhesive on the back side.

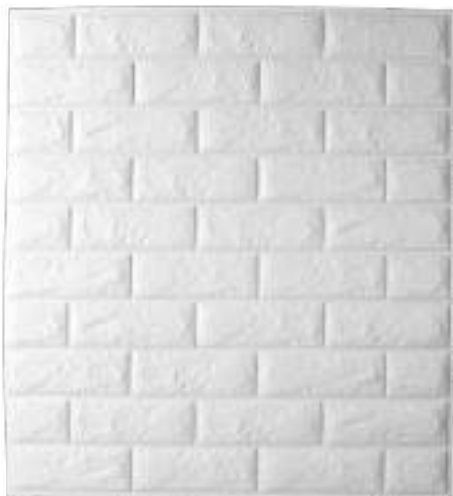

> **Material:** Foam
> **Dimensions:** 77x77x1cm

Weight
280gr

Category
F1

CODE	COLOR
36650	

Floor from Recycled Rubber



- > **Width:** 1,2m
- > **Length:** 10m
- > **Shape:** Roll

> **Specs:** Tough elastic, high compression resistance and impact strength, skid and spike resistant, non-slip, high abrasion resistance, comfortable and noise insulating.

Category
F2

CODE	MATERIAL	THICKNESS	COLOR	DENSITY	WEIGHT
94460	SBR	6mm	Black	990-1020 kg/m ³	5,9-6,1kg/m ²
94461		8mm			7,8-8,2kg/m ²
94463		10mm			9,8-10,2kg/m ²

More flake colors available upon request

CODE	MATERIAL	THICKNESS	COLOR	DENSITY	WEIGHT
94464	SBR & EPDM	6mm	Blue	980-1020 kg/m ³	5,9-6,1kg/m ²
94466			Yellow		
94465		Blue	7,8-8,2kg/m ²		
94469		Yellow			

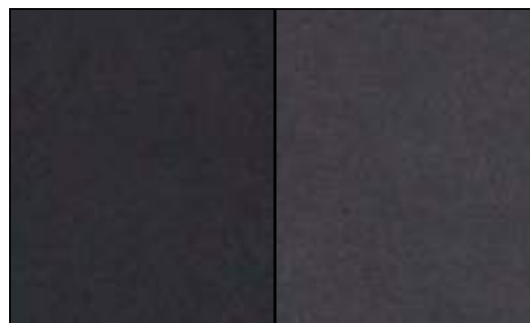

94455-94457 - Upper surface



94455-94457 - Lower surface

Floor from Recycled Rubber



94451 & 94453



94454

CODE	SURFACE	DIMENSIONS	THICK	SHAPE	COLOR	DENSITY	WEIGHT
94451	Smooth	100x50cm	15mm*	Tile	Black	850 kg/m ³	6,75 kg/pc
94453			20mm		Black		9,00 kg/pc
94454		100x100cm	15mm*		Black		13,50 kg/pc
94455			20mm		Black		18,00kg/pc
94456			20mm		Grey		

Constructed using a different process, its thickness is almost EXACTLY the stated above, offering a perfect fit after installation. At the same time, the smell emitted from the flooring is infinitesimal.
* 1 year warranty for code #94451 due to small thickness, 2 years for a thickness of 20mm.

Category
F2

> **Material:** Recycled rubber



BeGreen Active

BeGreen Active tiles have been designed so you can easily prepare a very good looking and personal sports area at backyard. Just imagine a maintenance-free garden that you will be able to set very quickly, without any installation cost.



BeGreen Astro

BeGreen Astro floor brings together a superb combination: the aesthetic result provided by artificial turf with the soft feeling of a rubber tile. They have been produced for using inside and outside. They can be used in multi-functional areas in sports fields and gyms.



- > **Base:** Recycled SBR Rubber
- > **Fibers:** 100% PE, density 300 micron, length 20 mm, Monofilament 9.000 / 6 DTEX (±5%)

CODE	DIMENSIONS	COLOR	THICKNESS	SHAPE
94474	48x98cm		15mm	Tile
94475	98x98cm		20mm	

Category F2



- > **Base:** Recycled SBR Rubber
- > **Fibers:** 100% PE, density 100 micron, length 20 mm, Monofilament 11.000 / 1 DTEX (±5%)

CODE	DIMENSIONS	COLOR	THICKNESS	SHAPE
94476	98x98cm		20mm	Tile
94477				

Weight 24Kg

Category F2

- > Make your Gym different with our Sprint track. Designed and manufactured to offer higher performance, its polyamide yarn (instead of PE) will offer you a solution for the track you need.
- > With the standard design, it is easy to do many types of exercises and it is perfect for long term indoor use.

Sprint Track

- > **Fibers:** 100% Polyamide coated with SBR latex, length 10 mm
- > **Weight:** 2.250gr/m²



CODE	DIMENSIONS	COLOR	THICKNESS	SHAPE
94478	1000x200cm		20mm	Roll
94479				

Category F2

Astroturf

- > **Fibers:** 100% PE, density 100 micron, length 20 mm, 28.160 knots/m², weight 1.400 gr/m²
- > **Base:** Thiolon K06 (Netherlands) 212 gr/m², covered by SBR Latex of DOW (Germany) 800 gr/m², weight 1.200 gr/m²



CODE	DIMENSIONS	COLOR	THICKNESS	SHAPE
94467	1000x200cm		20mm	Roll
94468				

Category F2

4613302

Total Hip
IF8109

Semi-Commercial Grade



Weight **88,5 Kg** PL Weights **113 Kg** Category **F2**

121×101×148cm

XZ5001

Rings

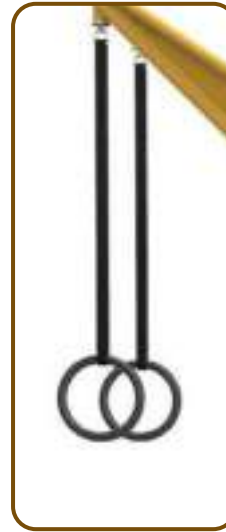

Category **Φ2**

XZ5002

Climbing Rope



Category **Φ2**

46640

Glute Isolator
E7024

- Practice angle for an effective contraction of the gluteus.
- Adjustable chest pad adapted to users of all sizes
- Grab handles and pads for forearms ensures a stable exercise position.



Weight **280 Kg** PL Weights **110 Kg** Category **F2**

214,5×130×152,8cm

46641

Back Extension
E7031

- With the adjustable back cushion, the user can easily find the correct position in relation to the axis of rotation.

- Two different height footrests adapt to different user sizes.
- The special design allows natural movements for excellent muscle contraction.
- The adjustable starting mechanism can be adjusted to the desired movement radius.



Weight **260 Kg** PL Weights **110 Kg** Category **F2**

128,5×105,5×152,8cm

M90T

Category F2

44894



KOREA

M905T

Category F2

44893



KOREA

Motor	3.00 hp AC (6 hp peak)
Console	Dot Matrix 16x32, 128x64mm, Heart rate sensors
Console Readings	Speed, Time, Remaining time, Distance, Heart rate, Calories, Incline, Pace (min/km)
Programs	10 predefined + 2 heart rate + 10 user + 3 target
Speed	0.1-18 Km/h
Incline	Electronic 0-15%, 30 levels
Deck	Waxed
Belt	51x152 cm
Rollers	Front 154x676mm, Ø88,5, Back 560mm, Ø88,5
Dimensions (open)	212x85x134 cm
Weight	195Kg
Max User Weight	185 Kg
Other Specs	Bottle holder, Tray

Motor	3.00 hp AC (6 hp peak)
Console	Dot Matrix 16x16, 64x64mm, Heart-rate sensors
Console Readings	Time, Distance, Calories, Speed, Heart rate, Incline, Pace (min/km)
Programs	6 predefined
Speed	0.1-18 Km/h
Incline	Electronic 0-15% 30 levels
Deck	61x138cm
Belt	52x152 cm
Rollers	Front 154x676mm, Ø88.5, Rear 560mm, Ø88.5
Dimensions (open)	221x85x134 cm
Weight	190Kg
Max User Weight	160 Kg
Other Specs	Bottle holder, Tray

NON-FOLDING
Commercial Grade



NON-FOLDING
Semi-Commercial Grade



MOTOR
ELECTRONICS and MPU INVERTER



CE



CE





Your Wellness Solution Provider

Impulse Health Tech Co. Ltd is a pioneering designer and manufacturer of Fitness equipment.

Its experience manufacturing strength and cardio fitness machines exceeds 35 years, while for over 18 years has been manufacturing the machines of the largest Fitness brands worldwide.

It's R&D department consists of more than 40 electrical engineers and mechanical engineers, working hard to meet the needs of the modern world of Fitness.

Its experience manufacturing strength and cardio fitness machines exceeds 35 years, while for over 18 years has been manufacturing the machines of the largest Fitness brands worldwide.

It's R&D department consists of more than 40 electrical engineers and mechanical engineers, working hard to meet the needs of the modern world of Fitness.

Why should I choose Impulse?

- 35 years of experience in equipment manufacturing
- Key manufacturer of many world-renowned brands
- Offering complete packages at competitive prices
- High quality of raw materials
- Designed by leading engineers
- Thousands of gyms around the world trust Impulse
- The very good service of the Greek dealership





I-zone Line

The Functional Training Zones by Impulse provide customizable and flexible solutions for CrossFit or working out with functional cages. It is paramount for it to be present in your gym and used for group training. The combinations of the series that can be constructed, plus the additional accessories, include: stretching, boxing, rebounder, step, dips and racks.

Whether you're a CrossFitter, or a plyometrics fanatic, or you just want to add some general usage exercises in your program, the I-Zone range has you covered. Take the medicine balls, kettlebells, speed/agility gear or strongman style equipment and raise your training to another level!



Learn more about I-Zone line
and the possible combinations at
www.amila.gr scan the QR-code



IZ-X Shape

» Includes:

- IZ7002
- IZ7003
- IZ7004
- IZ7005
- IZ7006
- IZ7007 (x2)

» Any other pictured product, other than those listed above, is not included.

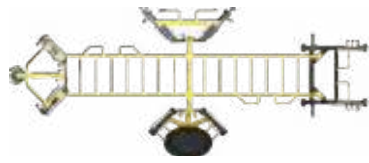

SPECIFICATIONS

Dimensions: 749x314x245 cm

NET weight: 928,5 kg

Category: F2

IZ-H Shape

IZ-O Shape

» Includes:

- IZ7001
- IZ7002
- IZ7003
- IZ7005
- IZ7015

» Any other pictured product, other than those listed above, is not included.



» Includes:

- IZ7001
- IZ7002
- IZ7003
- IZ7005
- Z7014



SPECIFICATIONS

Dimensions: 414x288x245 cm

NET weight: 833,6 kg

Category: F2

IZ-L Shape

IZ-L Shape

» Includes:

- IZ7001
- IZ7002
- IZ7003
- IZ7008
- IZ7011

» Any other pictured product, other than those listed above, is not included.

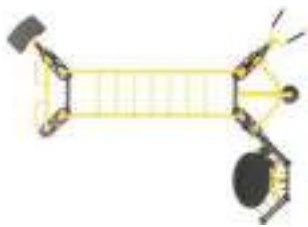

SPECIFICATIONS

Dimensions: 480x325x245 cm
 NET weight: 462,6 kg
 Category: F2

IZ-T Shape

IZ-T Shape

IZ-T Shape

» Includes:

- IZ7003
- IZ7004
- IZ7006
- IZ7007
- IZ7005 DAP

» Any other pictured product, other than those listed above, is not included.

» Includes:

- IZ7003
- IZ7004
- IZ7006
- IZ7007
- IZ7005 Stretch

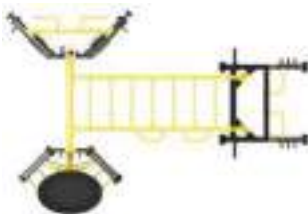

SPECIFICATIONS

Dimensions: 470x314x245 cm
 NET weight: 754,2 kg
 Category: F2

IZ-S Shape

IZ-S Shape

» Includes:

- IZ7001
- IZ7003
- IZ7011

» Any other pictured product, other than those listed above, is not included.



SPECIFICATIONS

Dimensions: 325x112x237 cm
 NET weight: 283,6 kg
 Category: F2

IZ-I Shape

IZ-I Shape

» Includes:

- IZ7001
- IZ7002
- IZ7008

» Any other pictured product, other than those listed above, is not included.

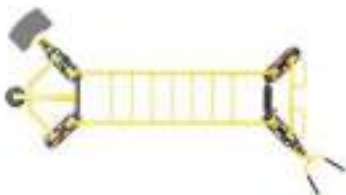

SPECIFICATIONS

Dimensions: 480x166x245 cm
 NET weight: 306 kg
 Category: F2

IZ7001

Stretching



SPECIFICATIONS

Dimensions: 165,5x168,3x236,4 cm
 NET weight: 127 kg
 Category: F2

IZ7002

Box

» The boxing bag is not included



SPECIFICATIONS

Dimensions: 165,5x112,6x239,0 cm
 NET weight: 142 kg
 Category: F2

IZ7003

Rebound

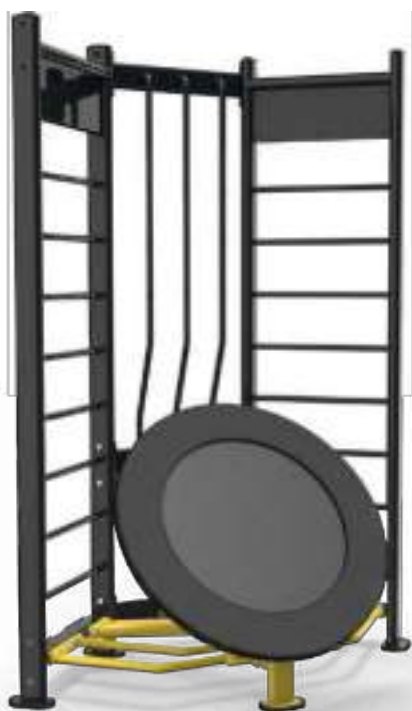

SPECIFICATIONS

Dimensions: 165,5x107,2x234 cm
 NET weight: 154 kg
 Category: F2

IZ7004

Half Rack



SPECIFICATIONS

Dimensions: 174,7x140,9x244,3 cm
 NET weight: 167 kg
 Category: F2



IZ7005



SPECIFICATIONS

Dimensions: 182,6x75,6x236,5 cm

NET weight: 383 kg

Category: F2

Dap

IZ7006



Connector

For IZ-T & IZ-X

SPECIFICATIONS

Dimensions: 152,8x17,8x20,5 cm

NET weight: 13,9 kg

Category: F2

IZ7011



“S” Joint

For S-Shape & L-Shape

SPECIFICATIONS

Dimensions: 17,8x10,0x5,0 cm

NET weight: 2,6 kg

Category: F2

IZ7007

Stair 2
For 4 stations



SPECIFICATIONS

Dimensions: 285,0x111,7x20,4 cm
NET weight: 38,3 kg
Category: F2

IZ7008

Stair 1
For 2 stations

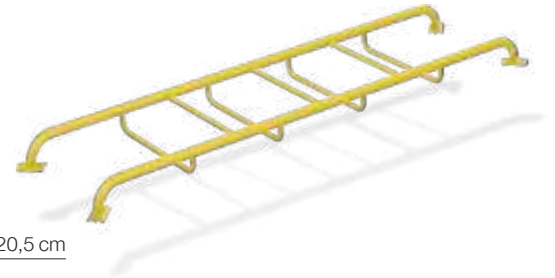

SPECIFICATIONS

Dimensions: 351,0x101,0x20,5 cm
NET weight: 43 kg
Category: F2

IZ7014

Stair
For IZ-0



SPECIFICATIONS

Dimensions: 243,5x120,7x20,5 cm
NET weight: 35,6 kg
Category: F2

IZ7015

Stair
For IZ-H



SPECIFICATIONS

Dimensions: 240,6x170,4x20,5 cm
NET weight: 53,9 kg
Category: F2

IZ7009

Step Attachment

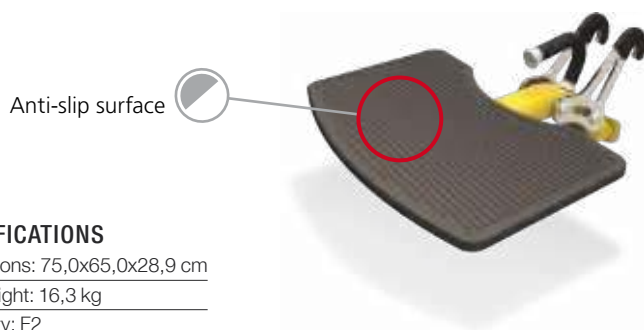

SPECIFICATIONS

Dimensions: 75,0x65,0x28,9 cm
NET weight: 16,3 kg
Category: F2

IZ7010

Dip Attachment



SPECIFICATIONS

Dimensions: 94,0x62,4x28,9 cm
NET weight: 12,6 kg
Category: F2

IZ7012

Pivot



SPECIFICATIONS

Dimensions: 53,1x12,6x17,8 cm
NET weight: 5,9 kg
Category: F2

IZ7017

Battle Rope Storage Reel



SPECIFICATIONS

Dimensions: 65,0x65,0 cm
NET weight: 24,6 kg
Category: F2



Mega Space Line

The Mega Space product line consists of specialized, more functional and customized range of racks designed for gyms.

These products can meet the needs of gyms, clubs and training centers for top quality and functional high quality equipment.



Learn more about the MS line
and the possible combinations at
www.amila.gr scan the QR-code



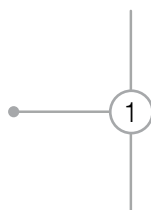

MS00 Stand-Single Storage x 2
 MS11 Lat Pulldown / Vertical Row x 2
 MS12 Functional Cable Pulley x 2
 MS22 Rack Connected Bridge
 Dimensions: 497x272,4x261,4 cm

MS00 Stand-Single Storage x 2
 MS02 Power Rack x 2
 MS11 Lat Pulldown / Vertical Row x 2
 MS12 Functional Cable Pulley x 2
 MS22 Rack Connected Bridge
 Dimensions: 497x453,7x261,4 cm

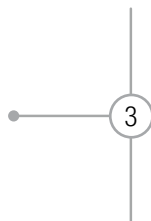
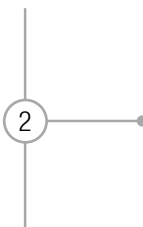

MS00 Stand-Single Storage x 2
 MS02 Power Rack x 4
 MS23 Bumper Plate Storage Connector Between Rack
 MS24 Kettlebell Storage Connector Between Rack
 MS25 Ball Storage Connector Between Rack
 MS26 Dumbbell Storage Connector Between Rack
 Dimensions: 497x468,4x261,4 cm

MS 11

LAT Pulldown / Vertical Row

- » Space saving, on the basis of providing the same use function and custom effect of conventional two single-station strength instruments, greatly saving the space.
- » The weight stack is NOT included, you may choose from the ones for IT95 line (p. 310)

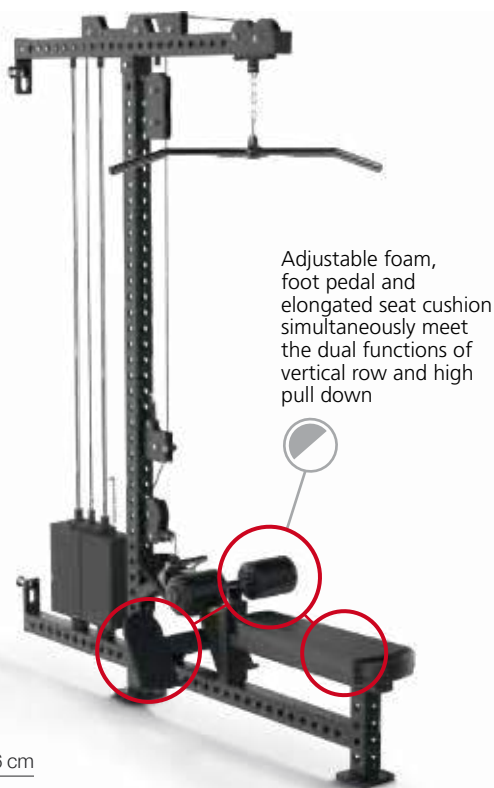

SPECIFICATIONS

Dimensions: 122,6x216,0x259,6 cm
 NET weight: 102 kg
 Category: F2

MS 12

Functional Cable Pulley

- » Through collocation can be combined into cable crossover
- » The weight stack is NOT included, you may choose from the ones for IT95 line (p. 310)

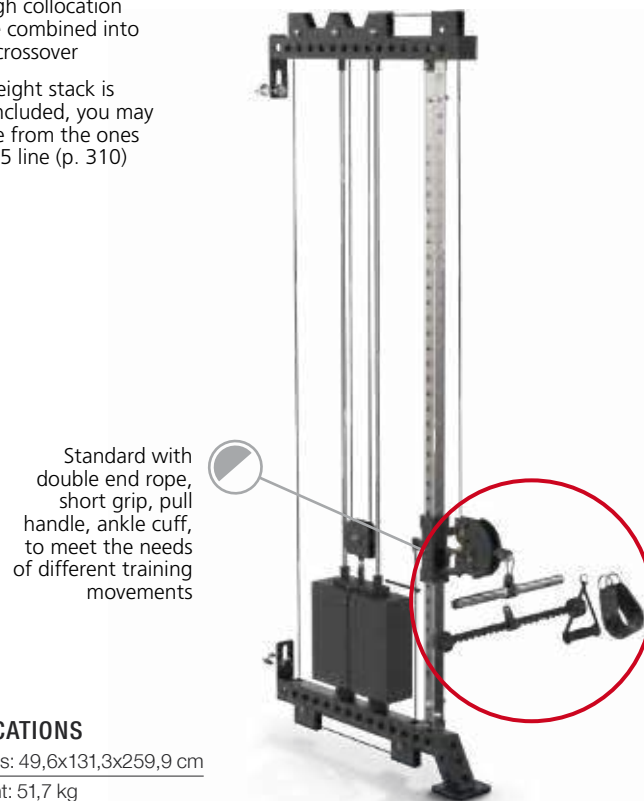

SPECIFICATIONS

Dimensions: 49,6x131,3x259,9 cm
 NET weight: 51,7 kg
 Category: F2

MS00

ESENTIAL PART

Stand - Single Storage

- » Use with MS01 and MS02 racks
- » Also connects to MS11 LAT Pulldown/ Vertical Row and MS12 Functional Cable Pulley
- » Can be connected with: MS15, MS23, MS24, MS25, MS26

There are 8 groups of weight plate storage units on the left and right sides, which fully meet the weight plate storage requirements

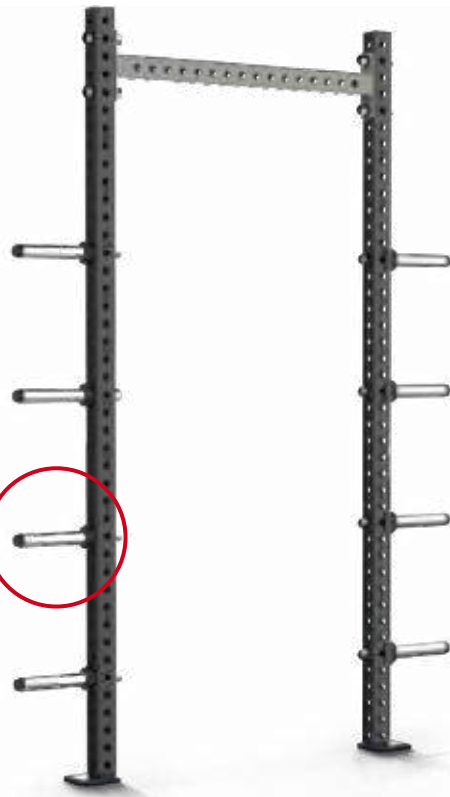

MS01

MS02



MS11

MS12



SPECIFICATIONS

Dimensions: 179,0x60,9x261,4 cm
 NET weight: 83,4 kg
 Category: F2

MS01

Half Rack

MS02

Power Rack

2 J-hooks

30 height positions (465mm~2145mm from the ground)

2 spotter arms

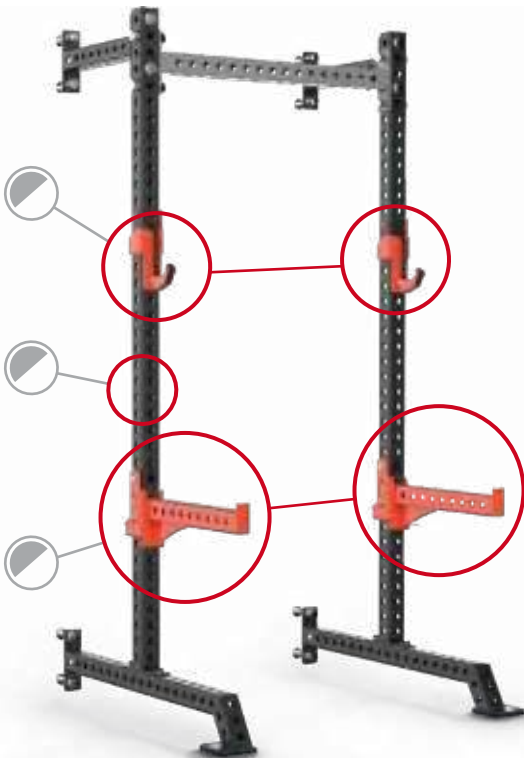

2 J-hooks

30 height positions (465mm~2145mm from the ground)

2 spotter arms

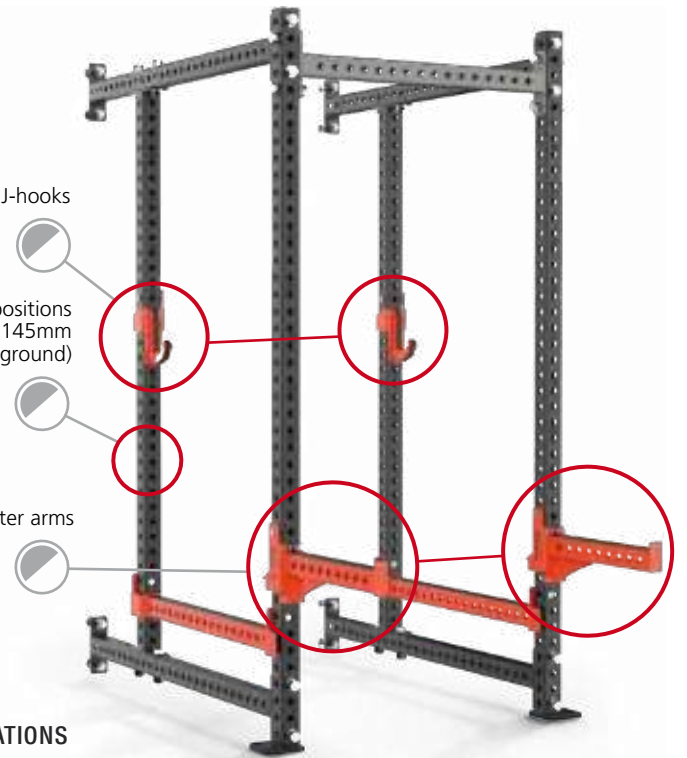

SPECIFICATIONS

Dimensions: 137,7x126,1x261,4 cm
 NET weight: 98,3 kg
 Category: F2

SPECIFICATIONS

Dimensions: 137,7x230,6x261,4 cm
 NET weight: 173 kg
 Category: F2

MS13

Jammer Arms

- » Multi-angle handle to meet the needs of different training movements, while the handle is removable and portable.
- » No disassembly need, can be adjusted up and down to any height, fixed through the bolt
- » Various functions, covering chest, shoulder, back, legs, buttocks and most of the muscle group training movements, and can greatly save space.
- » Can be combined with: MS14, MS45 & MS43



SPECIFICATIONS

Dimensions: 87,5x36,9x139,5 cm
 NET weight: 51 kg
 Pieces / Code: 2
 Category: F2

MS15

Endless Rope Trainer

- » Magnetic control resistance adjustment structure is simple, reliable and durable.
- » The resistance of four levels can be adjusted to meet the training needs of different groups

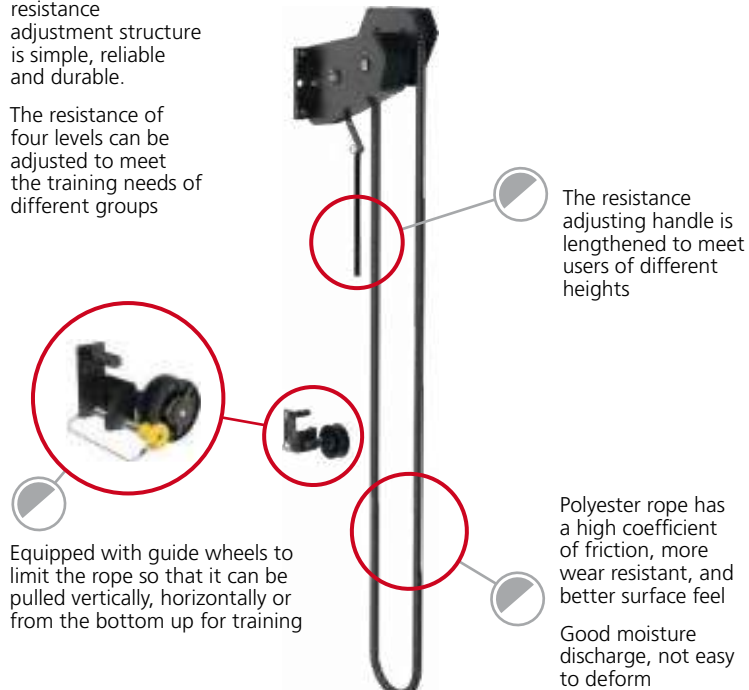

SPECIFICATIONS

Dimensions: 26,6x52,7x53,7 cm
 NET weight: 32,9 kg
 Category: F2

MS31

Platform

- » For use with MS00 and MS01, fixed to the metal frames to ensure being firm and reliable
- » Ensures stable support, prevents slip, absorbs shocks, reduces noises and protects the ground



SPECIFICATIONS

Dimensions: 244,6x342,1x5,0 cm
 NET weight: 264 kg
 Category: F2

CONSTRUCTIONS

Non-slip varnished surface
 Bamboo on top layer
 Composite wood on bottom layer

MS32

Platform

- » For use with MS00 and MS02, fixed to the metal frames to ensure being firm and reliable
- » Ensures stable support, prevents slip, absorbs shocks, reduces noises and protects the ground



SPECIFICATIONS

Dimensions: 257,6x382,5x5,4 cm
 NET weight: 280 kg
 Category: F2

CONSTRUCTIONS

Non-slip varnished surface
 Bamboo on top layer
 Composite wood on bottom layer

MS21

Rack Connected Bridge

» It can be used as a high bridge to connect the top of the power rack, and can be used as a low connector to connect the bottom of the power rack to match the battle rope and other accessories.



SPECIFICATIONS

Dimensions: 205,6x24,0x19,2 cm
NET weight: 17,3 kg
Category: F2

MS22

Rack Connected Bridge

» It can be used as a high bridge to connect the top of the power rack, and can be used as a low connector to connect the bottom of the power rack to match the battle rope and other accessories.



SPECIFICATIONS

Dimensions: 275,6x24,0x19,2 cm
NET weight: 21,4 kg
Category: F2

HSPCF29

Triphasic Training Arms

» Can be combined with elastic belt for centripetal, centrifugal, isometric training



SPECIFICATIONS

Dimensions: 72,1x108,1x10,5 cm
NET weight: 32 kg
Pieces / Code: 2
Category: F2

IZCFA16

Heavy Bag Hanger

» All kinds of sandbags can be hung up to 200kg



SPECIFICATIONS

Dimensions: 96,3x76,2x6,0 cm
NET weight: 12,8 kg
Category: F2

MS26

Dumbbell Storage Connector Between Rack



SPECIFICATIONS

Dimensions: 212,0x38,5x227,0 cm
NET weight: 24 kg
Category: F2

MS24

Kettlebell Storage Connector Between Rack



SPECIFICATIONS

Dimensions: 212,0x44,1x10,7 cm
NET weight: 37,5 kg
Category: F2

MS25

Ball Storage Connector Between Rack



SPECIFICATIONS

Dimensions: 212,0x38,5x10,8 cm
NET weight: 15 kg
Category: F2

MS23

Bumper Plate Storage Connector Between Rack



SPECIFICATIONS

Dimensions: 212,0x38,5x28,6 cm
NET weight: 20,1 kg
Category: F2

IZCFA12

* The Wall Balls are not included in the above price of IZCFA12

SPECIFICATIONS

Dimensions: 55,0x24,6x60,8 cm
NET weight: 17,6 kg
Category: F2



Combine the target* with the Wall Balls you prefer, according to the material and the weight or make a combination of them, depending on your needs (p. 137-139)

Wall Ball Target

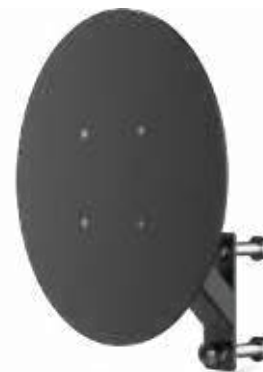

HSPCF52

Landmine Rack Attachment

It is equipped with transverse and longitudinal bearings, so that it can rotate 180° in both axes

SPECIFICATIONS

Dimensions: 12,6x53,0x24,0 cm
NET weight: 8 kg
Category: F2

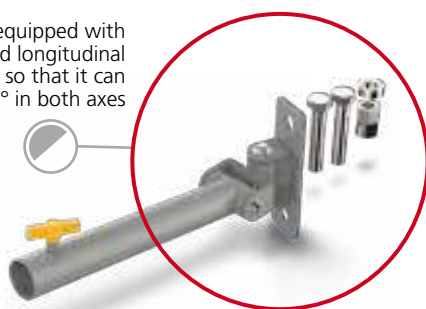

MS14

Belt Squat

SPECIFICATIONS

Dimensions: 111,2x55,0x67,7 cm
NET weight: 21,8 kg
Category: F2

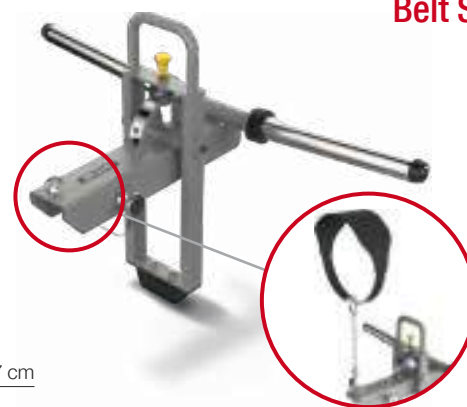

HSPCF28

Multi Angle Pull Up Handle

» A variety of width of grips, and multi-angle to meet the needs of different height users

SPECIFICATIONS

Dimensions: 114,3x32,4x10,9 cm
NET weight: 12,8 kg
Category: F2



HSPCF42

Tricep Dip Attachment

» When not in use, the latch can be pulled out and vertically fixed and stored on the main frame.

SPECIFICATIONS

Dimensions: 64,9x77,9x25,0 cm
NET weight: 10,1 kg
Category: F2



MS27

Side Storage

» Can meet all kinds of ball props such as rhythm ball, wall ball, medicine ball and other storage needs

SPECIFICATIONS

Dimensions: 99,5x41,6x76,3 cm
NET weight: 30,8 kg
Category: F2



MS44

Barbell-Utility Platform Storage Attachment

» 2 barbell bar storage positions
» Utility Platform (MS41) storage Position

SPECIFICATIONS

Dimensions: 28,0x24,0x18,0 cm
NET weight: 6 kg
Category: F2



MS41

Adjustable Utility Platform

- » It can be used with the safety bar, and has the function of box jumping
- » Anti-slip paint can effectively prevent skid



SPECIFICATIONS

Dimensions: 134,0x40,0x7,7 cm
 NET weight: 20 kg
 Category: F2

MS43

Adjustable Utility Pins

- » Επιπλέον μπορούν να χρησιμοποιηθούν για ασκήσεις με λάστιχα

- » At the same time, they can be used for elastic band training



SPECIFICATIONS

Dimensions: 59,0 cm
 NET weight: 6,8 kg
 Pieces / Code: 2
 Category: F2

MS45

Foam Roller Pads

- » Μπορεί να τοποθετηθεί στην εσωτερική πλευρά των μπράτσων πιέσεων (MS13) για γέφυρα ισχύου

- » It can be placed inside the MS13 Jammer Arm for hip bridge



SPECIFICATIONS

Dimensions: 55,9 cm
 NET weight: 7,3 kg
 Pieces / Code: 2
 Category: F2

HSPCF49

Safety Straps

- » Προστατευτικό μπάρας σε περίπτωση πτώσης

- » Bar protector in case of fall



SPECIFICATIONS

Dimensions: 115,0x5,0x1,0 cm
 NET weight: 10,1 kg
 Pieces / Code: 2
 Category: F2

HSPCF54

J Hook Attachment

- » Γάτζοι για στήριξη μπάρας (2 τεμάχια)



SPECIFICATIONS

Dimensions: 22,4x29,6x22,4 cm
 NET weight: 6,8 kg
 Pieces / Code: 2
 Category: F2

HSPCF51

Battle Rope Anchor

- » Used as a fixed point for the battle rope when training



SPECIFICATIONS

Dimensions: 7,0x15,2x18,0 cm
 NET weight: 2,1 kg
 Category: F2

HSPCF59

Ball Grip Attachment

- » Gripping strength training attachment
- » Three different grips



SPECIFICATIONS

Dimensions: 20,7/32,1/44,3x20,9x7,6 cm
 NET weight: 7,8 kg
 Pieces / Code: 7
 Category: F2

HSPCF47

Resistant Band Anchor

- » Serve as elastic belt hangpoints to meet advanced strength training



SPECIFICATIONS

Dimensions: 30,5 cm
 NET weight: 6,2 kg
 Pieces / Code: 4
 Category: F2



[SE] Sterling Elite Series

The Sterling Elite series offers maximum flexibility and highly commercial exercise solutions with its customizable modular design.

The wide variety of combinations that can be achieved with the series' machines meet the special needs of training centers, gyms, as well as studios looking for strength training or CrossFit equipment.

They are made from thicker tubing and more durable materials than the SL series, ensuring you stay safe and get the most out of your workout.



Learn more about the SE line and the possible combinations at www.amila.gr scan the QR-code



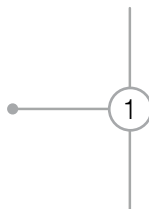

SE5001 Half Rack
SE5011 Stand-Single Storage
SE5031 Platform

SE5002 Power Rack
SE5011 Stand-Single Storage
SE5031 Platform

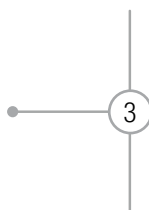
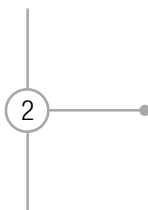

SE5001 Half Rack
SE5002 Power Rack
SE5012 Combo Storage-Single

SE5002 Power Rack x 2
SE5012 Combo Storage-Single

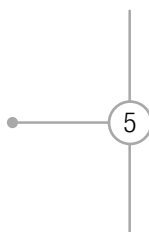
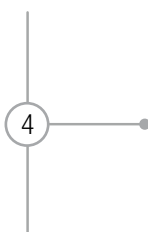

SE5001 Half Rack
SE5002 Power Rack
SE5011 Stand-Single Storage x 2
SE5025 Ball Storage Connector
SE5024 Free Storage Connector
SE5021 Rack Connector / Multi-Grip

SE5001 Half Rack x 3
SE5002 Power Rack
SE5012 Combo Storage-Single x 2
SE5025 Ball Storage Connector
SE5024 Free Storage Connector
SE5023 Bumper Plate Storage Connector
SE5021 Rack Connector / Multi-Grip
SE5031 Platform

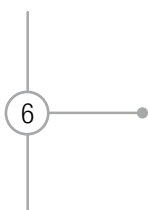

SE5001

Half Rack



2 J-hooks

2 spotter arms

SPECIFICATIONS

Dimensions: 133,8x130,1x247,6 cm
 NET weight: 118,3 kg
 Category: F2

SE5002

Power Rack



2 J-hooks

SPECIFICATIONS

Dimensions: 133,8x196,8x247,6 cm
 NET weight: 193,3 kg
 Category: F2

SE5011

Stand-Single Storage

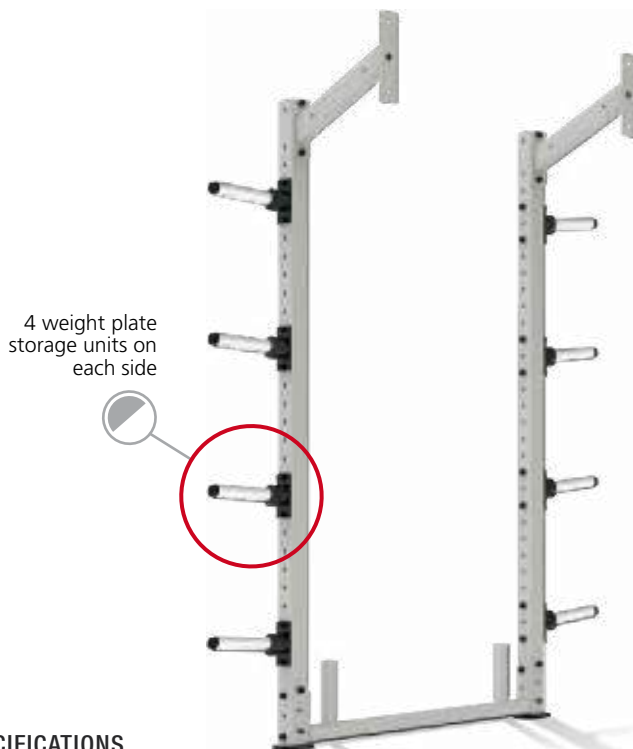

4 weight plate storage units on each side

SPECIFICATIONS

Dimensions: 184,2x56,3x246,6 cm
 NET weight: 64,4 kg
 Category: F2

SE5012

Combo Storage-Single



4 weight plate storage units on each side

SPECIFICATIONS

Dimensions: 184,2x103,1x246,6 cm
 NET weight: 73,4 kg
 Category: F2

SE5021

Rack Connector / Multi-Grip



SPECIFICATIONS

Dimensions: 190,0x22,5x23,0 cm
 NET weight: 19,5 kg
 Category: F2

SE5022

Rack Connector-Thick Straight



SPECIFICATIONS

Dimensions: 190,0x7,6x23,0 cm
 NET weight: 8 kg
 Category: F2

SE5023

Bumper Plate Storage Connector



SPECIFICATIONS

Dimensions: 190,0x7,6x23,0 cm
 NET weight: 24,5 kg
 Category: F2

SE5024

Free Storage Connector



SPECIFICATIONS

Dimensions: 190,0x43,2x17,1 cm
 NET weight: 36,5 kg
 Category: F2

SE5025

Ball Storage Connector



SPECIFICATIONS

Dimensions: 190,0x28,0x26,0 cm
 NET weight: 14 kg
 Category: F2

SE5043

Spotter Stands



SPECIFICATIONS

Dimensions: 40,0x23,5x44,2 cm
 NET weight: 24 kg
 Pieces / Code: 2
 Category: F2

HZ7010

Dip Attachment



SPECIFICATIONS

Dimensions: 62,5x94,6x33,9 cm
NET weight: 12,6 kg
Category: F2

HZ7009

Step Attachment



SPECIFICATIONS

Dimensions: 66,1x77,3x33,8 cm
NET weight: 16,3 kg
Category: F2

IZ7012

Pivot

» Can be used ONLY with SE5002



SPECIFICATIONS

Dimensions: 12,6x53,0x28,9 cm
NET weight: 5,9 kg
Category: F2

SE5041

Band Pegs



SPECIFICATIONS

Dimensions: 32,5x10,1x5,0 cm
NET weight: 4,5 kg
Pieces / Code: 2
Category: F2

HZ7008

Battle Rope Attachment



SPECIFICATIONS

Dimensions: 17,8x12,9x6,0 cm
NET weight: 1,4 kg
Category: F2

SE5042

Reverse J-Hooks



SPECIFICATIONS

Dimensions: 9,5x25,2x25,0 cm
NET weight: 13,7 kg
Pieces / Code: 2
Category: F2

in impulse

H-Zone Line

Specially designed to provide flexibility and functionality, allows you to use the full area of your gym, even curved, narrow and difficult to access areas.

All stations can be securely attached to the wall.



Learn more about the HZ line
and the possible combinations at
www.amila.gr scan the QR-code



Two connectors offering full flexibility and adaptability, even in the most demanding areas

Multi-Function Connector

The HZ7004 multifunctional connector allows the flexible connection of the stations to it, giving you the freedom to combine the stations and their accessories any way you like



Wall Connector

The HZ7006 wall connector, due to its rotatable fixing plates, allows the fixation of the stations to any wall in any angle, offering superb stability





Impulse inovated to maximize the usability of the Rack και Hi-Low pulley stations

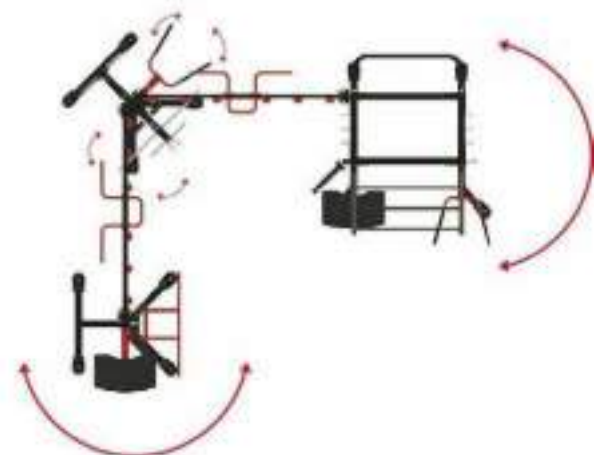

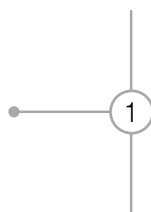

HZ7002 Hi-Low Pulley Station x 2
 HZ7004 Multi-Function Connector

HZ7001 Power Rack Station
 HZ7002 Hi-Low Pulley Station
 HZ7003 Multi-Function Station
 HZ7004 Multi-Function Connector x 2

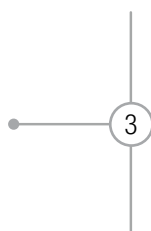
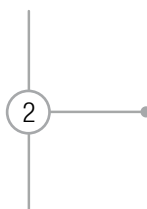

HZ7001 Power Rack Station
 HZ7002 Hi-Low Pulley Station
 HZ7003 Multi-Function Station
 HZ7004 Multi-Function Connector x 2

HZ7010

Dip Attachment



SPECIFICATIONS

Dimensions: 62,5x94,6x33,9 cm
 NET weight: 12,6 kg
 Category: F2

HZ7009

Step Attachment



SPECIFICATIONS

Dimensions: 66,1x77,3x33,8 cm
 NET weight: 16,3 kg
 Category: F2

IZ7012

Pivot



SPECIFICATIONS

Dimensions: 12,6x53,0x28,9 cm
 NET weight: 5,9 kg
 Category: F2

HZ7008

Battle Rope Attachment



SPECIFICATIONS

Dimensions: 17,8x12,9x6,0 cm
 NET weight: 1,4 kg
 Category: F2

HZ7001

Power Rack Station



SPECIFICATIONS

Dimensions: 173,7x172,3x255,8 cm
 NET weight: 180,0 kg
 Category: F2

HZ7002

Hi-Low Pulley Station



SPECIFICATIONS

Dimensions: 110,6x110,9x241,3 cm
 NET weight: 82 kg
 Category: F2

HZ7003

Multi-Function Station



SPECIFICATIONS

Dimensions: 114,2x112,3x241,1 cm
 NET weight: 75 kg
 Category: F2

HZ7004

Multi-Function Connector



SPECIFICATIONS

Dimensions: 228,4x45,3x20,3 cm
 NET weight: 30 kg
 Category: F2

HZ7006

Wall Connector



SPECIFICATIONS

Dimensions: 86,6x20,0x7,5 cm
 NET weight: 6 kg
 Category: F2

in *impulse*

SL Line

Ease of Use - Pretty Appearance

SL line boasts a high quality construction for commercial use with user friendly design, which makes working out more simple, efficient, comfortable and satisfying.

Compact design, demanding the least possible space, while the resistance is adjusted by adding/removing disks.



Tubing with thickness ranging from 2.5mm to 3mm, 50mmx100mm, electro-welded for maximum integrity

Electrostatic powder-coated and heat cured after adhesiveness enhancement pre-treatment for superior durability

Pad total thickness is 70mm

Place disks to change the resistance

Easy-to-use, flexible adjustments allow for optimal exercise positions

2 weight plate storage units on each side



Learn more about the SL line at www.amila.gr scan the QR-code

Muscle groups:
● Main ● Secondary

SL7001

Chest Press

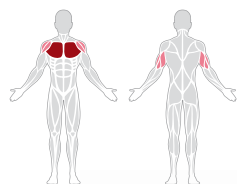

SPECIFICATIONS

Dimensions: 198,0x137,5x171,8 cm
 NET weight: 171 kg
 Weight capacity: 300 kg
 Category: F2

SL7002

Pulldown

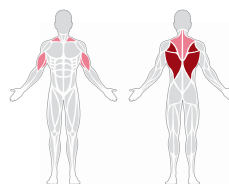

SPECIFICATIONS

Dimensions: 140,8x165,9x197,3 cm
 NET weight: 169 kg
 Weight capacity: 300 kg
 Category: F2

SL7003

Shoulder Press

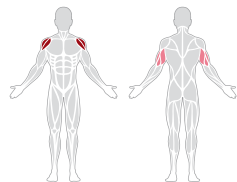

SPECIFICATIONS

Dimensions: 175,4x154,5x148,2 cm
 NET weight: 171 kg
 Weight capacity: 300 kg
 Category: F2

SL7004

Low Row

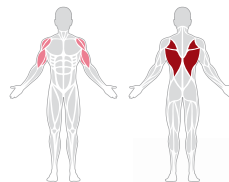

SPECIFICATIONS

Dimensions: 152,6x176,1x165,2 cm
 NET weight: 170 kg
 Weight capacity: 300 kg
 Category: F2

SL7005

Incline Chest Press

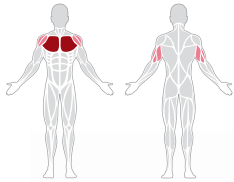

SPECIFICATIONS

Dimensions: 207,2x152,3x176,5 cm
 NET weight: 184 kg
 Weight capacity: 300 kg
 Category: F2

SL7007

Row

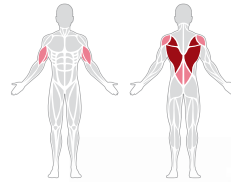

SPECIFICATIONS

Dimensions: 145,5x181,5x133,4 cm
 NET weight: 160 kg
 Weight capacity: 300 kg
 Category: F2

SL7046

Iso-Lateral Super Chest Press

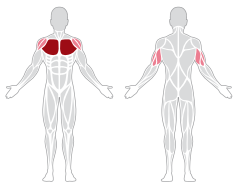

SPECIFICATIONS

Dimensions: 217,1x249,2x113,2 cm
 NET weight: 148kg
 Weight capacity: 150 kg
 Category: F2

SL7024

Tricep Dip

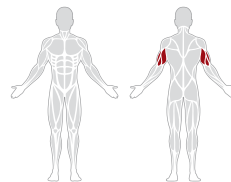

SPECIFICATIONS

Dimensions: 157,8x173,1x120,4 cm
 NET weight: 166 kg
 Weight capacity: 300 kg
 Category: F2

SL7023

Bicep Curl

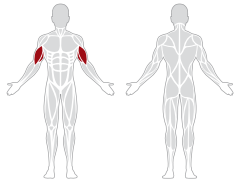

SPECIFICATIONS

Dimensions: 104,5x149,4x119,9 cm
 NET weight: 114 kg
 Weight capacity: 120 kg
 Category: F2

SL7019

Incline Row

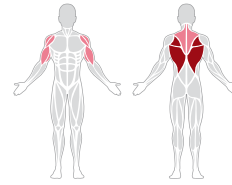

SPECIFICATIONS

Dimensions: 104,8x196,3x126,2 cm
 NET weight: 89 kg
 Weight capacity: 150 kg
 Category: F2

SL7032

Standing Calf Raise

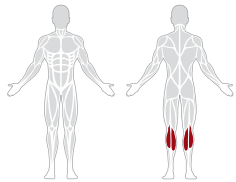

SPECIFICATIONS

Dimensions: 160,5x148,5x181,3 cm
 NET weight: 146 kg
 Weight capacity: 300 kg
 Category: F2

SL7034

Squat

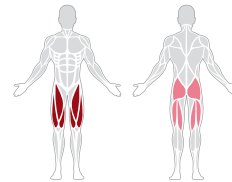

SPECIFICATIONS

Dimensions: 155,5x230,2x126,6 cm
 NET weight: 212 kg
 Weight capacity: 400 kg
 Category: F2

SL7020

Reverse Leg Press

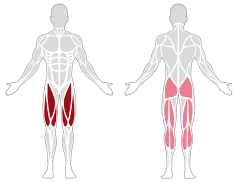

SPECIFICATIONS

Dimensions: 193,3x246,1x153,4 cm
 NET weight: 249 kg
 Weight capacity: 450 kg
 Category: F2

SL7021

Hack Squat

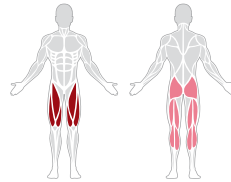

SPECIFICATIONS

Dimensions: 188,0x220,6x128,6 cm
 NET weight: 236 kg
 Weight capacity: 400 kg
 Category: F2

SL7006

Leg Press

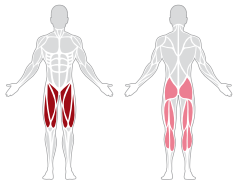

SPECIFICATIONS

Dimensions: 142,1x226,6x141,5 cm
 NET weight: 195 kg
 Weight capacity: 400 kg
 Category: F2

SL7025

Leg Extension

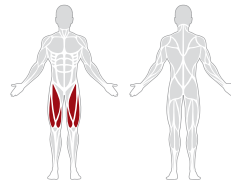

SPECIFICATIONS

Dimensions: 169,0x134,5x103,7 cm
 NET weight: 131 kg
 Weight capacity: 300 kg
 Category: F2

SL7038

Total Hip

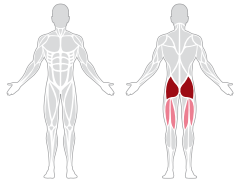

SPECIFICATIONS

Dimensions: 160,8x161,8x110,6 cm
 NET weight: 115 kg
 Weight capacity: 150 kg
 Category: F2

SL7040

Squat Lunge

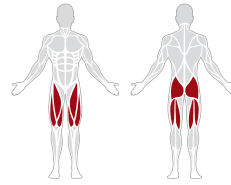

SPECIFICATIONS

Dimensions: 169,4x166,8x63,6 cm
 NET weight: 123 kg
 Weight capacity: 300 kg
 Category: F2

SL7026

Leg Curl

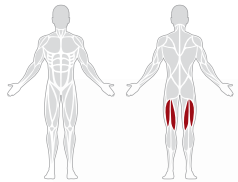

SPECIFICATIONS

Dimensions: 130,0x152,7x140,6 cm
 NET weight: 141 kg
 Weight capacity: 120 kg
 Category: F2

SL7017

Seated Calf Raise

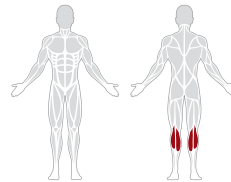

SPECIFICATIONS

Dimensions: 75,7x147,5x84,4 cm
 NET weight: 56 kg
 Weight capacity: 150 kg
 Category: F2

SL7013

Glute Ham Bench

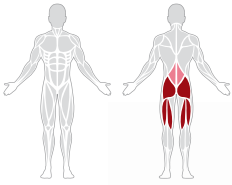

SPECIFICATIONS

Dimensions: 89,9x155,9x148,2 cm
 NET weight: 70 kg
 Weight capacity: 150 kg
 Category: F2

SL7047

Multi Hyper Extension

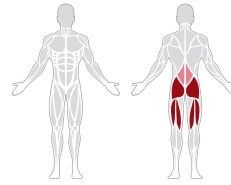

SPECIFICATIONS

Dimensions: 94,7x134,0x87,2 cm
 NET weight: 55 kg
 Weight capacity: 150 kg
 Category: F2

SL7008

Rear Kick

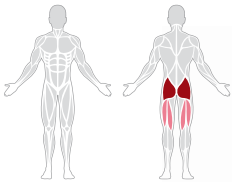

SPECIFICATIONS

Dimensions: 129,9x168,0x163,8 cm
 NET weight: 144 kg
 Weight capacity: 150 kg
 Category: F2

SL7031

Shoulder Bench Press

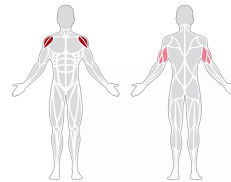

SPECIFICATIONS

Dimensions: 171,9x126,1x192,0 cm
 NET weight: 147 kg
 Weight capacity: 400 kg
 Category: F2

SL7028

Flat Bench

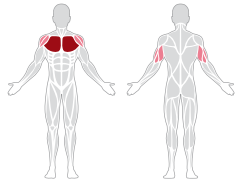

SPECIFICATIONS

Dimensions: 173,8x191,0x131,5 cm
 NET weight: 112 kg
 Weight capacity: 300 kg
 Category: F2

SL7029

Incline Bench

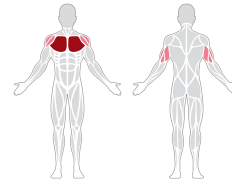

SPECIFICATIONS

Dimensions: 171,8x205,9x149,6 cm
 NET weight: 113 kg
 Weight capacity: 300 kg
 Category: F2

SL7030

Decline Bench

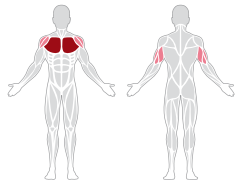

SPECIFICATIONS

Dimensions: 171,8x237,0x131,5 cm
 NET weight: 110 kg
 Weight capacity: 300 kg
 Category: F2

SL7041

Super Olympic Bench

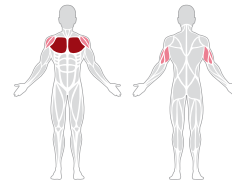

SPECIFICATIONS

Dimensions: 241,0x174,3x162,2 cm
 NET weight: 141 kg
 Weight capacity: 300 kg
 Category: F2

SL7045

Vertical Knees Raise / Dip Stand

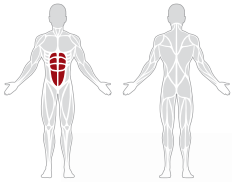

SPECIFICATIONS

Dimensions: 76,5x118,9x153,7 cm
 NET weight: 74 kg
 Weight capacity: 150 kg
 Category: F2

SL7045OPT

Chin-up and Dip
 (add-on of SL7045)

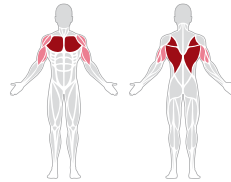

SPECIFICATIONS

Dimensions: 113,0x118,9x238,7 cm
 NET weight: 32 kg
 Weight capacity: 150 kg
 Category: F2

SL7036

Abdominal

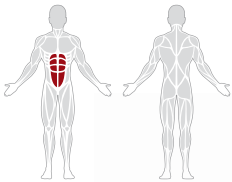

SPECIFICATIONS

Dimensions: 134,4x126,7x164,2 cm
 NET weight: 132 kg
 Weight capacity: 120 kg
 Category: F2

SL7043

Multi AB Bench

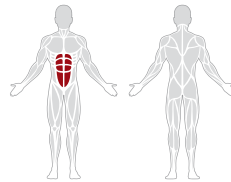

SPECIFICATIONS

Dimensions: 63,0x172,2x91,2 cm
 NET weight: 54 kg
 Weight capacity: 150 kg
 Category: F2

SL7042



SPECIFICATIONS

Dimensions: 232x224x239 cm
 NET weight: 313 kg
 Weight capacity: 300 kg
 Category: F2

SL7009

Power Rack



SPECIFICATIONS

Dimensions: 203x150x228 cm
 NET weight: 200 kg
 Weight capacity: 400 kg
 Category: F2

SL7009OPT

Weight Plate Rack Option

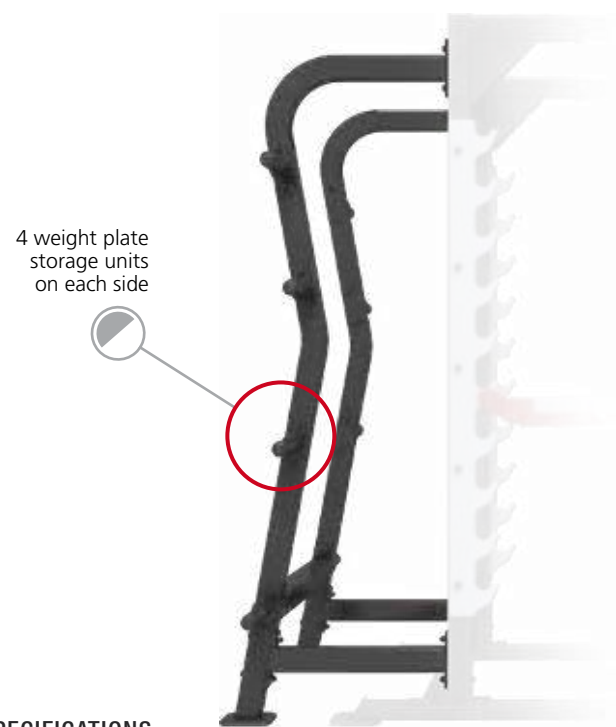

SPECIFICATIONS

Dimensions: 167x72x220 cm
 NET weight: 63,5 kg
 Category: F2

SL7014

Half Rack



SPECIFICATIONS

Dimensions: 139x175x244 cm
 NET weight: 153 kg
 Weight capacity: 400 kg
 Category: F2

SL7015

Full Rack



SPECIFICATIONS

Dimensions: 197x175x244 cm
 NET weight: 216 kg
 Weight capacity: 400 kg
 Category: F2

SL7011

FID Bench



SPECIFICATIONS

Dimensions: 150x66x136 cm
 NET weight: 44 kg
 Weight capacity: 150 kg
 Category: F2

SL7012

FID Bench



Spotter
Stands

SPECIFICATIONS

Dimensions: 155x67x135 cm
 NET weight: 47 kg
 Weight capacity: 150 kg
 Category: F2

SL7018

Arm Curl



SPECIFICATIONS

Dimensions: 114x86x102 cm
 NET weight: 70 kg
 Weight capacity: 300 kg
 Category: F2

SL7035

Flat Bench



SPECIFICATIONS

Dimensions: 135x123x151 cm
 NET weight: 25.3 kg
 Category: F2

SL7022

Utility Bench



SPECIFICATIONS

Dimensions: 119x63x82,2 cm
 NET weight: 27.8 kg
 Category: F2

SL7010

Plate Rack



SPECIFICATIONS

Dimensions: 89x62,8x122,8 cm
 NET weight: 44 kg
 Category: F2

SL7016

Dumbbell Rack

* The pictured dumbbells are not included in the price



SPECIFICATIONS

Dimensions: 123x119x151 cm
 NET weight: 124 kg
 Category: F2



Combine the Dumbbell Rack* by choosing the dumbbells you like according to their material and weight (p. 114-116)

in impulse

FE Line

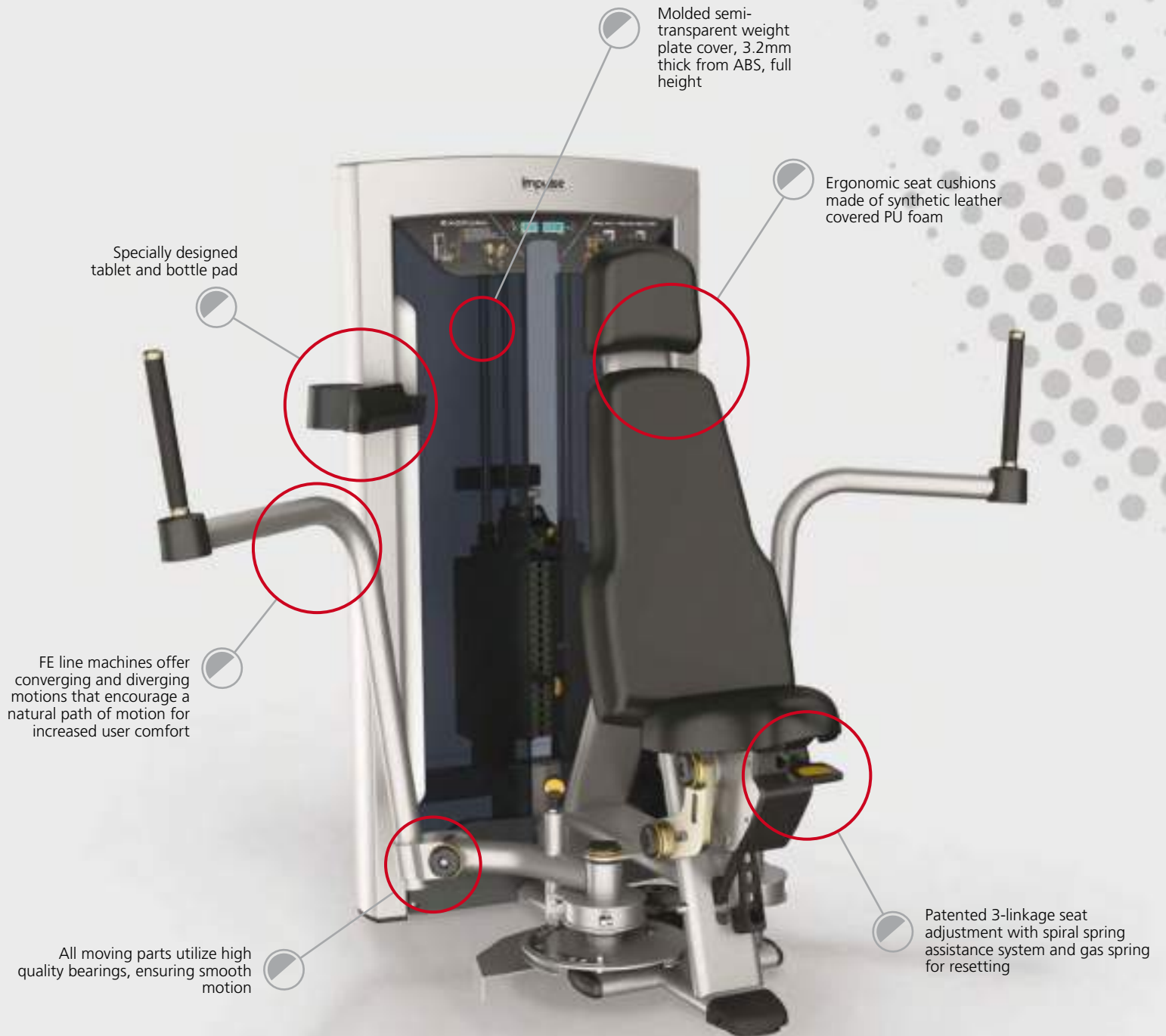

Commercial-use machines combining elegant design with affordable price and an extensive list of features that allow every user to enjoy the benefits of fitness training in a safe, engaging and effective way.

The minimum 5lbs (2.25kg) change in resistance allows you to adjust the resistance exactly to your preference.

User-friendly design allows easy entry and exit

EXO|FORM

Concise and easy to read exercise placards offer a quick reference to targeted muscle groups and proper machine use, also including repetition and time counters

Ergonomically designed TPU grips with aluminum caps for a more refined look

3mm thick 72.8x141.7mm main frame tubes, with double layer electrostatic paint

Deep V notched glass fiber reinforced nylon pulleys, offering minimum resistance

Self-lubricating cables tested for a 300.000 repetition service life



Learn more about the FE line at www.amila.gr scan the QR-code

The weight stack is not included in the price of the machines

Muscle groups:

● Main ● Secondary

FE9701

Chest Press

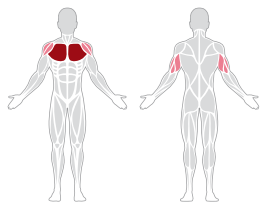

FE9701B

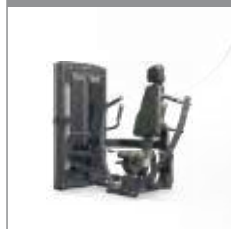

SPECIFICATIONS

Dimensions: 156,5x122,9x149,0 cm
NET weight: 170 kg
Category: F2

FE9715

Pec Fly / Rear Delt

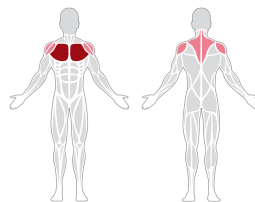

FE9715B

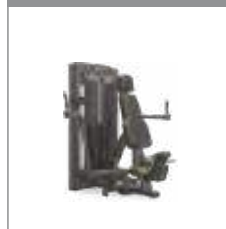

SPECIFICATIONS

Dimensions: 172,1x134,0x149,0 cm
NET weight: 161 kg
Category: F2

FE9703

Arm Curl

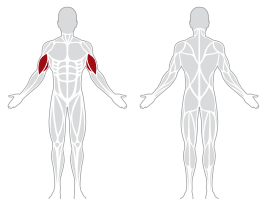

FE9703B



SPECIFICATIONS

Dimensions: 156,7x114,9x149,0 cm
NET weight: 170 kg
Category: F2

FE9712

Shoulder Press

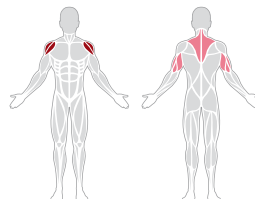

FE9712B

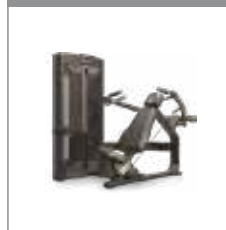

SPECIFICATIONS

Dimensions: 142,2x176,5x149,0 cm
NET weight: 169 kg
Category: F2

FE9723

Tricep

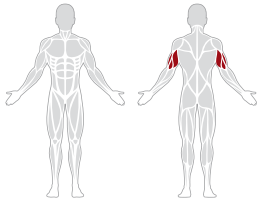

FE9723B



SPECIFICATIONS

Dimensions: 158,0x114,9x149,0 cm
NET weight: 164 kg
Category: F2

FE9720

Weight Assisted Chin / Dip Combo

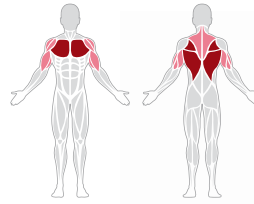

FE9720B



SPECIFICATIONS

Dimensions: 175,0x138,0x219,8 cm
NET weight: 244 kg
Category: F2

FE9719

Row

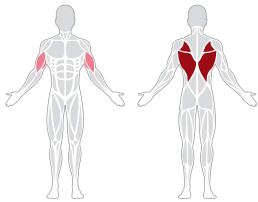

FE9719B



SPECIFICATIONS

Dimensions: 112,7x199,6x149,2 cm
NET weight: 175 kg
Category: F2

FE9702

Lat Pulldown

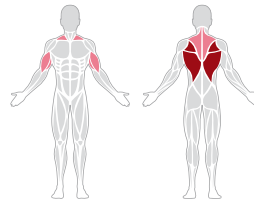

FE9702B



SPECIFICATIONS

Dimensions: 130,4x122,6x210,9 cm
NET weight: 177 kg
Category: F2

FE9714

Abdominal

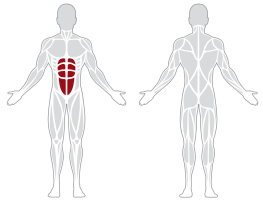

FE9714B



SPECIFICATIONS

Dimensions: 120,2x138,3x149,0 cm
NET weight: 142 kg
Category: F2

FE9732

Back Extension

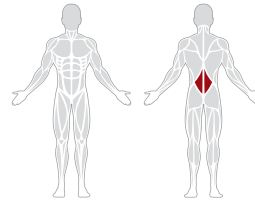

FE9732B

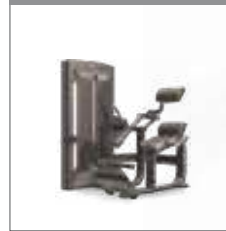

SPECIFICATIONS

Dimensions: 122,3x138,3x148,9 cm
NET weight: 185 kg
Category: F2

FE9705

Leg Extension

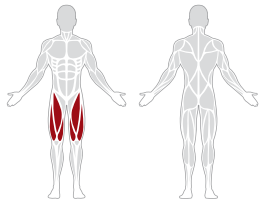

FE9705B



SPECIFICATIONS

Dimensions: 124,0x149,2x149,0 cm
NET weight: 170 kg
Category: F2

FE9706

Seated Leg Curl

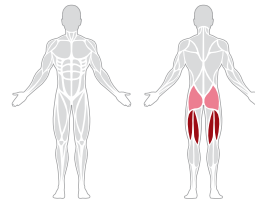

FE9706B



SPECIFICATIONS

Dimensions: 124,0x154,1x148,8 cm
NET weight: 184 kg
Category: F2

FE9726

Glute

Όργανο Ενδυνάμωσης Γλουτών

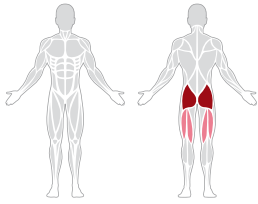

FE9726B



SPECIFICATIONS

Dimensions: 130,7x155,8x148,8 cm

NET weight: 168,5 kg

Category: F2

FE9708

Abductor-Adductor

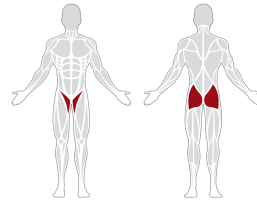

FE9708B

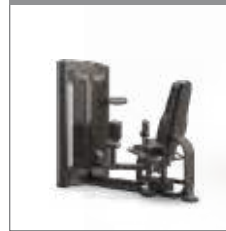

SPECIFICATIONS

Dimensions: 151,4x172,7x148,8 cm

NET weight: 166 kg

Category: F2

FE9710

Leg Press

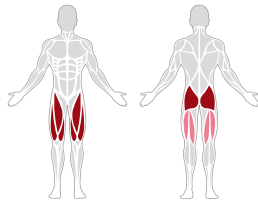

FE9710B

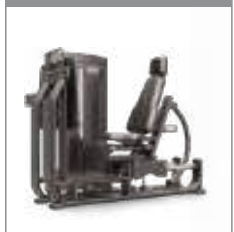

SPECIFICATIONS

Dimensions: 134,8x178,6x148,9 cm

NET weight: 279 kg

Category: F2

FE9716

Calf Raise

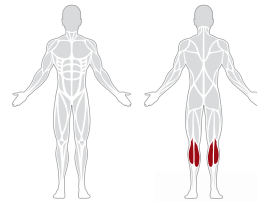

FE9716B

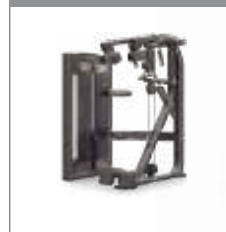

SPECIFICATIONS

Dimensions: 118,7x123,0x174,5 cm

NET weight: 168kg

Category: F2

FE9721

Prone Leg Curl

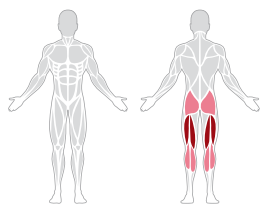

FE9721B



SPECIFICATIONS

Dimensions: 119,3x170,5x149,2 cm
 NET weight: 154 kg
 Category: F2

FE97WS200

Weight Stack

» Weight stack:
90Kg / 200Lbs

FE97WS235

» Weight stack:
106Kg / 235Lbs

FE97WS295

» Weight stack:
134Kg / 295Lbs



in impulse

IT95 Line



Concise and easy to read exercise placards offer a quick reference to targeted muscle groups and proper machine use

3mm tube in main frame and movement parts. U-frame uses 95x81.1x3 tube and functional parts use 50x100

Ergonomically designed TPU grips with aluminum caps for a more refined look

IT95 line machines offer diverging motions that allows the arm training simultaneously and alternately

The IT95 line (evolution from IT93) is the core of the strength training machines and represents its design and quality.

Their design allows easy entry and exit, considerably improves the feeling during their use, while the seat adjustment can be done while being seated.

These machines can be equipped with 4 different weight stacks, while also support incremental weight (5 lbs) for smaller adjustments.

IT95 line, with its elegant and beautiful design, high quality and many features, is available in two colors (grey and black), consisting the perfect choice for your gym.



Versatile accessory pad

Double stitched, with added protection cover on the back

The weight stack is fully covered by a polycarbonate sheet on both sides, conforming with the latest security directives and compatible with the CN directive

USA imported cable which passed more than 250 thousand times test

All moving part incorporate high quality bearings ensuring smooth motion

Lathed pulley with less tolerance



Learn more about the IT95 line at www.amila.gr scan the QR-code

Available colors:
● Grey ● Black

The weight stack is not included in the price

Muscle groups:
● Main ● Secondary

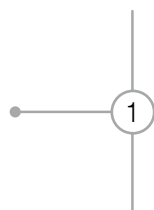

IT9525S Adjustable Hi/Lo Pulley
 IT95270PTS Cable Crossover Traditional
 IT9525S Adjustable Hi/Lo Pulley

IT9527S 4 Stack Multi-Station
 IT95270PTS Cable Crossover Traditional
 IT9525S Adjustable Hi/Lo Pulley

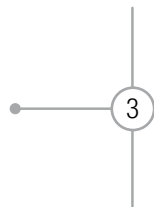
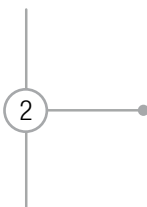

IT9527S 4 Stack Multi-Station
 IT95270PTS Cable Crossover Traditional
 IT9527S 4 Stack Multi-Station

IT95WS160

Weight Stack
 Πλάκες Βαρών

» Weight stack:
 73Kg / 160Lbs

IT95WS200

» Weight stack:
 90Kg / 200Lbs

IT95WS235

» Weight stack:
 106Kg / 235Lbs

IT95WS295

» Weight stack:
 134Kg / 295Lbs



IT95270PTS

Cable Crossover Traditional



SPECIFICATIONS

Dimensions: 282,4x47,7x22,1 cm

NET weight: 27,5 kg

Category: F2

IT95270PT

Cable Crossover Traditional



SPECIFICATIONS

Dimensions: 282,4x47,7x22,1 cm

NET weight: 27,5 kg

Category: F2

IT9525

Adjustable Hi/Lo Pulley



IT9525S



SPECIFICATIONS

Dimensions: 146,3x126,2x235,8 cm
NET weight: 138 kg
Category: F2

IT9527

4 Stack Multi-Station



IT9527S



SPECIFICATIONS

Dimensions: 221,4x348,9x238,2 cm
NET weight: 309 kg
Category: F2

IT9530

Dual Adjustable Pulley



IT9530S



SPECIFICATIONS

Dimensions: 162,0x137,0x227,0 cm
NET weight: 196 kg
Category: F2

IT9501

Chest Press

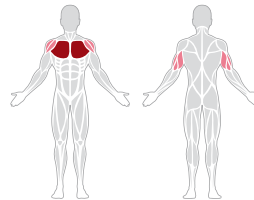

IT9501S



SPECIFICATIONS

Dimensions: 147,5x119,1x150,6 cm
NET weight: 128 kg
Category: F2



IT9504

Pectoral

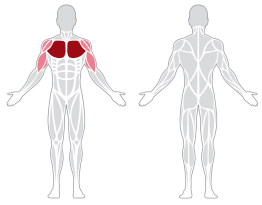

IT9504S



SPECIFICATIONS

Dimensions: 144,9x136,1x150,7 cm
 NET weight: 145 kg
 Category: F2

IT9515

Pec Fly / Rear Delt

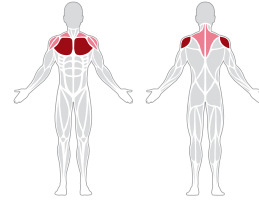

IT9515S



SPECIFICATIONS

Dimensions: 127,5x127,1x204,8 cm
 NET weight: 124 kg
 Category: F2

IT9517

Dip Press

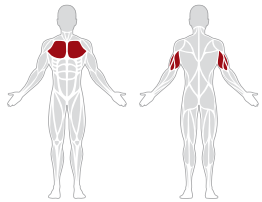

IT9517S



SPECIFICATIONS

Dimensions: 123,3x169,4x150,6 cm
 NET weight: 143 kg
 Category: F2

IT9520

Weight Assisted Chin / Dip Combo

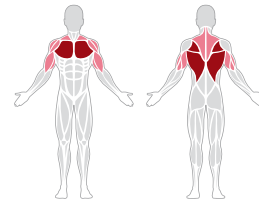

IT9520S



SPECIFICATIONS

Dimensions: 157,3x131,5x228,6 cm
 NET weight: 171 kg
 Category: F2

IT9522

Lat Pulldown / Vertical Row

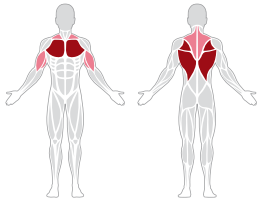

IT9522S



SPECIFICATIONS

Dimensions: 122,3x189,7x222,8 cm
NET weight: 120 kg
Category: F2

IT9529

Multi Press

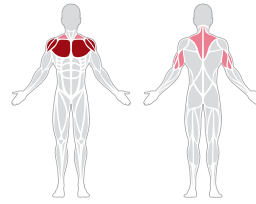

IT9529S



SPECIFICATIONS

Dimensions: 143,7x182,7x166,9 cm
NET weight: 166 kg
Category: F2

IT9533

Bicep / Tricep

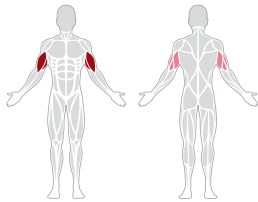

IT9533S



SPECIFICATIONS

Dimensions: 122,5x130,0x150,6 cm
NET weight: 132 kg
Category: F2

IT9503

Arm Curl

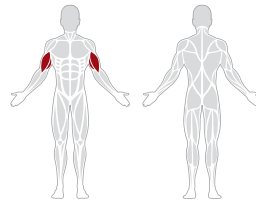

IT9503S



SPECIFICATIONS

Dimensions: 120,8x122,5x150,7 cm
NET weight: 116 kg
Category: F2

IT9502

Lat Pull

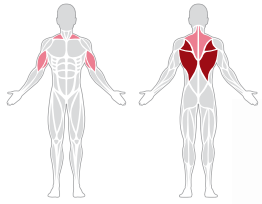

IT9502S



SPECIFICATIONS

Dimensions: 138,0x143,4x188,9 cm
NET weight: 148 kg
Category: F2

IT9519

Row

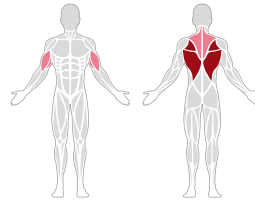

IT9519S



SPECIFICATIONS

Dimensions: 126,4x161,6x150,6 cm
NET weight: 127 kg
Category: F2

IT9512

Shoulder Press

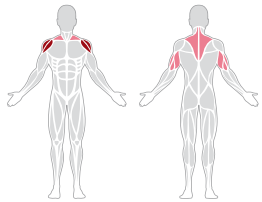

IT9512S



SPECIFICATIONS

Dimensions: 144,3x156,0x151,0 cm
NET weight: 137 kg
Category: F2

IT9524

Lateral Raise

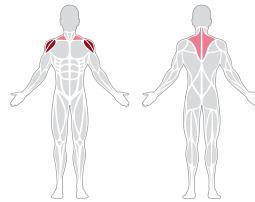

IT9524S



SPECIFICATIONS

Dimensions: 121,3x122,2x150,6 cm
NET weight: 128 kg
Category: F2

IT9514

AB Machine

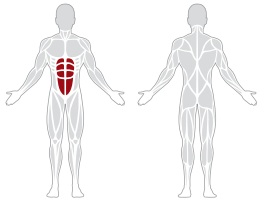

IT9514S



SPECIFICATIONS

Dimensions: 114,8x134,6x158,1 cm
NET weight: 113 kg
Category: F2

IT9518

Torso Rotation

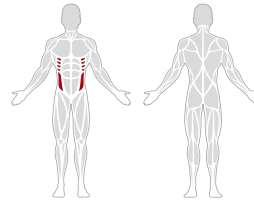

IT9518S



SPECIFICATIONS

Dimensions: 119,0x114,9x150,6 cm
NET weight: 151 kg
Category: F2

IT9534

Abdominal / Back Extension

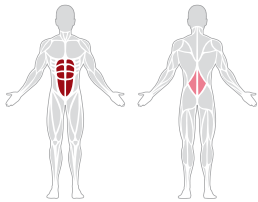

IT9534S



SPECIFICATIONS

Dimensions: 118,9x119,6x150,6 cm
NET weight: 139 kg
Category: F2

IT9532

Back Extension

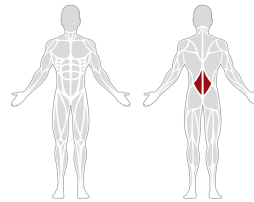

IT9532S



SPECIFICATIONS

Dimensions: 118,9x123,3x150,6 cm
NET weight: 124 kg
Category: F2

IT9508

Abductor and Adductor

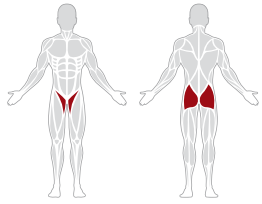

IT9508S



SPECIFICATIONS

Dimensions: 89,7x155,3x150,6 cm
NET weight: 150 kg
Category: F2



IT9526

Glute

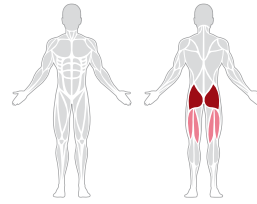

IT9526S



SPECIFICATIONS

Dimensions: 121,7x161,5x150,6 cm
NET weight: 124 kg
Category: F2



IT9521

Prone Leg Curl

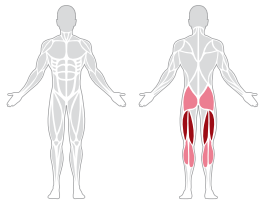

IT9521S



SPECIFICATIONS

Dimensions: 114,5x145,8x150,6 cm
NET weight: 132 kg
Category: F2



IT9510

Leg Press

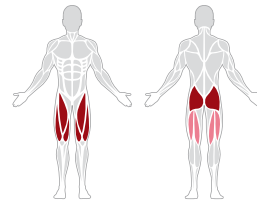

IT9510S



SPECIFICATIONS

Dimensions: 113,7x185,0x150,6 cm
NET weight: 211 kg
Category: F2



IT9505

Leg Extension

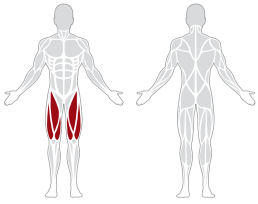

IT9505S



SPECIFICATIONS

Dimensions: 118,5x122,0x150,6 cm
NET weight: 133 kg
Category: F2

IT9506

Seated Leg Curl

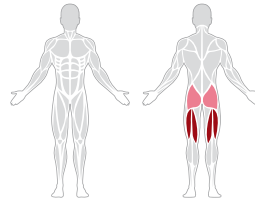

IT9506S



SPECIFICATIONS

Dimensions: 118,6x153,6x150,6 cm
NET weight: 150 kg
Category: F2

IT9516

Calf Raise

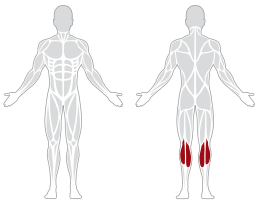

IT9516S



SPECIFICATIONS

Dimensions: 115,6x128,7x173,9 cm
NET weight: 128 kg
Category: F2

IT9528

Leg Extension / Leg Curl

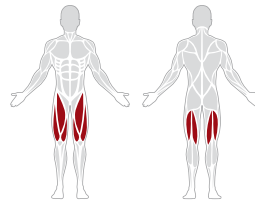

IT9528S

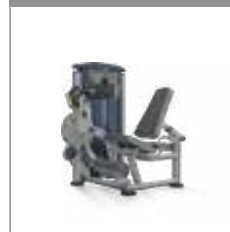

SPECIFICATIONS

Dimensions: 123,0x137,5x150,6 cm
NET weight: 167 kg
Category: F2

in impulse

IF93 Line



Ergonomically designed TPV grips with aluminum caps for a more refined look

Specially designed cup holder perfectly integrated in cage

The translucent half-shroud on the back, made from ABS, with high endurance and wear resisting

All pulleys have high quality bearings which ensure smooth movement

Impulse's IF93 line is designed with simple clear lines and is ideal for small gyms and clubs.

It is inexpensive to own, easy to maintain, while offering a wide range of exercises.

The clear and precise instructions and training tips are great for individuals who are new to strength training and help users to build targeted muscles

The main frame is coated with materials that are environmental friendly, helping to improve the product's quality and provide good scratching and corrosion resistance



The upright tubing thickness of 2.5mm and the functional parts with rectangular tube at size of 50x100x2.5mm make IF93 stronger and with high endurance

Ergonomic seat cushions, chest and back pads are made of polymer materials; the specially designed pads have different angles, which meet various training requirements

Designed with stainless steel seat adjustment that provides a longer service life, makes it easy to adjust and looks beautiful



Learn more about the IF93 line at www.amila.gr scan the QR-code

The weight stack is not included in the price

Muscle groups:
● Main ● Secondary

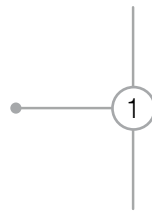

IF9325
IF9327OPT
IF9325

Adjustable Hi/Lo Pulley
Cable Crossover Traditional
Adjustable Hi/Lo Pulley

IF9327
IF9327OPT
IF9325

4 Stack Multi-Station
Cable Crossover Traditional
Adjustable Hi/Lo Pulley

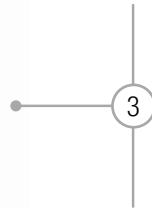
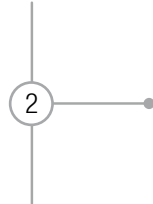

IF9327
IF9327OPT
IF9327

4 Stack Multi-Station
Cable Crossover Traditional
4 Stack Multi-Station

IF9327OPT

Cable Crossover Traditional



SPECIFICATIONS

Dimensions: 250,5x44,1x19,8 cm

NET weight: 21,5 kg

Category: F2

IF9330

Dual Adjustable Pulley



SPECIFICATIONS

Dimensions: 163,9x88,2x227,0 cm

NET weight: 117 kg

Category: F2

IF93WS160

Weight Stack

» Weight: 73Kg/160Lbs

IF93WS200

» Weight: 90Kg/200Lbs

IF93WS235

» Weight: 106Kg/235Lbs

IF93WS295

» Weight: 134Kg/295Lbs



IF9325

Adjustable Hi/Lo Pulley



SPECIFICATIONS

Dimensions: 144,9x125,8x233,8 cm
 NET weight: 96 kg
 Category: F2

IF9327

4 Stack Multi-Station



SPECIFICATIONS

Dimensions: 244,5x342,7x233,8 cm
 NET weight: 257 kg
 Category: F2

IF9301

Chest Press

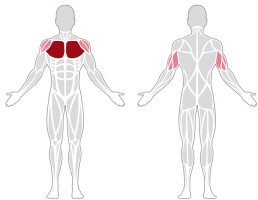

SPECIFICATIONS

Dimensions: 136,0x118,8x153,0 cm
 NET weight: 97,1 kg
 Category: F2

IF9304

Pectoral

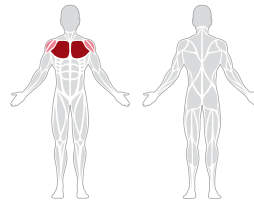

SPECIFICATIONS

Dimensions: 173,6x80,6x153,0 cm
 NET weight: 95 kg
 Category: F2

IF93 15

Pectoral

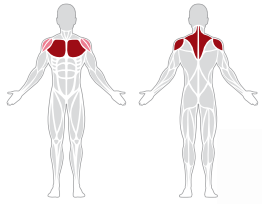

SPECIFICATIONS

Dimensions: 149,3x142,1x186,3 cm
 NET weight: 90 kg
 Category: F2

IF93 20

Weight Assisted Chin / Dip Combo

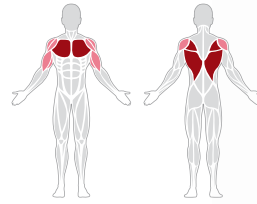

SPECIFICATIONS

Dimensions: 130,9x125,6x249,8 cm
 NET weight: 107 kg
 Category: F2

IF93 29

Multi-Press

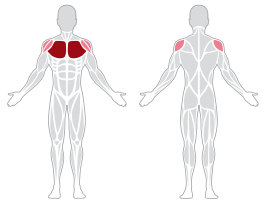

SPECIFICATIONS

Dimensions: 144,6x202,6x153,0 cm
 NET weight: 97,5 kg
 Category: F2

IF93 24

Lateral Raise

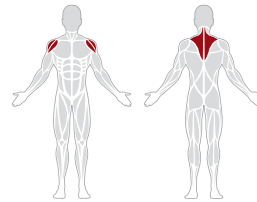

SPECIFICATIONS

Dimensions: 75,0x119,7x153,0 cm
 NET weight: 85 kg
 Category: F2

IF9312

Shoulder Press

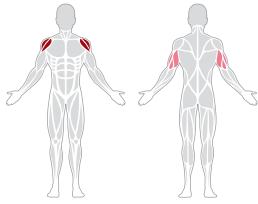

SPECIFICATIONS

Dimensions: 145,6x145,0x153,0 cm
 NET weight: 103 kg
 Category: F2

IF9303

Arm Curl

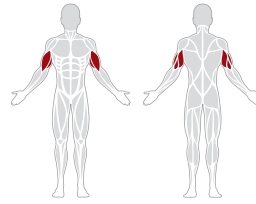

SPECIFICATIONS

Dimensions: 102,8x121,6x153,0 cm
 NET weight: 90 kg
 Category: F2

IF9333

Bicep Curl / Tricep Extension

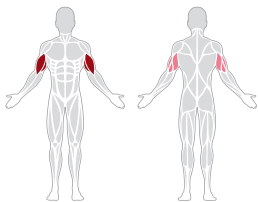

SPECIFICATIONS

Dimensions: 120,3x132,7x153,0 cm
 NET weight: 110 kg
 Category: F2

IF9317

Seated Dip

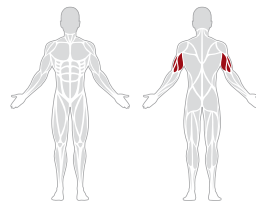

SPECIFICATIONS

Dimensions: 121,2x122,7x153,0 cm
 NET weight: 97,5 kg
 Category: F2

IF9302

Lat Pulldown

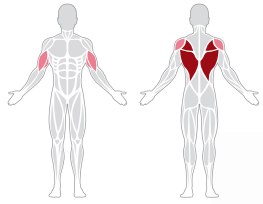

SPECIFICATIONS

Dimensions: 131,8x158,3x189,1 cm
NET weight: 100 kg
Category: F2

IF9319

Vertical Row

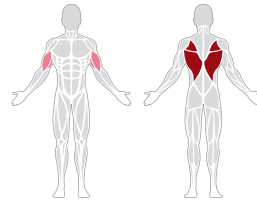

SPECIFICATIONS

Dimensions: 85,8x180,4x153,0 cm
NET weight: 91,5 kg
Category: F2

IF9322

Lat Pulldown

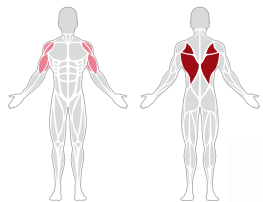

SPECIFICATIONS

Dimensions: 122,3x188,6x222,7 cm
NET weight: 91 kg
Category: F2

IF9314

Abdominal

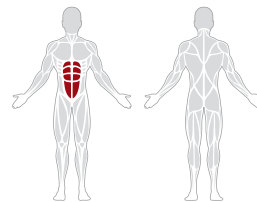

SPECIFICATIONS

Dimensions: 100,8x108,5x153,0 cm
NET weight: 89,5 kg
Category: F2

IF9318

Torso Rotation

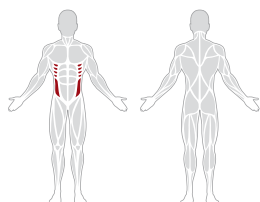

SPECIFICATIONS

Dimensions: 124,0x110,3x153,0 cm
 NET weight: 96 kg
 Category: F2

IF9332

Back Extension

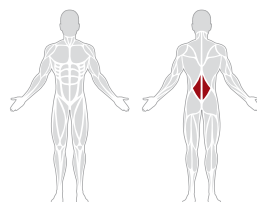

SPECIFICATIONS

Dimensions: 103,4x112,0x153,0 cm
 NET weight: 98 kg
 Category: F2

IF9335

Abductor

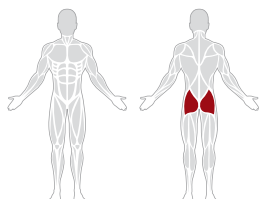

SPECIFICATIONS

Dimensions: 94,6x158,3x153,0 cm
 NET weight: 95 kg
 Category: F2

IF9326

Kick Back

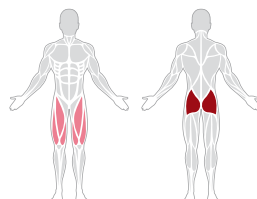

SPECIFICATIONS

Dimensions: 106,8x103,4x153,0 cm
 NET weight: 90 kg
 Category: F2

IF9308

Abductor / Adductor

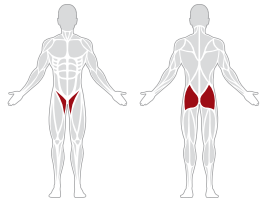

SPECIFICATIONS

Dimensions: 93,5x157,0x153,0 cm
 NET weight: 103 kg
 Category: F2

IF9305

Leg Extension

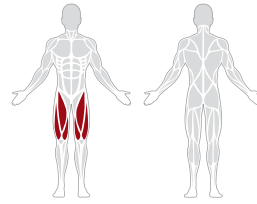

SPECIFICATIONS

Dimensions: 104,8x114,6x153,0 cm
 NET weight: 102 kg
 Category: F2

IF9306

Seated Leg Curl

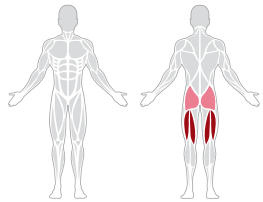

SPECIFICATIONS

Dimensions: 103,4x144,8x153,0 cm
 NET weight: 95 kg
 Category: F2

IF9316

Calf Raise

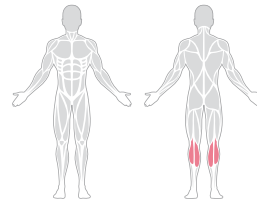

SPECIFICATIONS

Dimensions: 110,5x115,0x177,5 cm
 NET weight: 106 kg
 Category: F2

IF9328

Leg Extension / Leg Curl

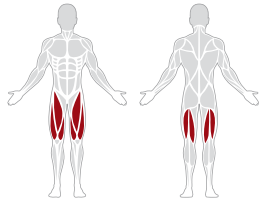

SPECIFICATIONS

Dimensions: 127,0x127,2x153,0 cm
NET weight: 105 kg
Category: F2

IF9321

Prone Leg Curl

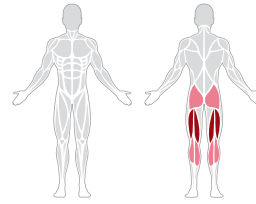

SPECIFICATIONS

Dimensions: 114,6x150,7x153,0 cm
NET weight: 102 kg
Category: F2

IF9336

Adductor

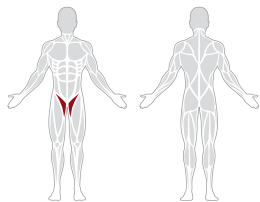

SPECIFICATIONS

Dimensions: 118,5x158,3x153,0 cm
NET weight: 95 kg
Category: F2

IF9310

Leg Press

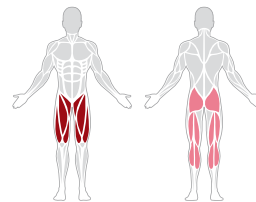

SPECIFICATIONS

Dimensions: 116,8x205,5x153,0 cm
NET weight: 121 kg
Category: F2

in impulse
IT70 Line



The Impulse IT70 line boasts high quality, commercial strength, designed to fulfill any commercial need.

Its attractive and user friendly design helps people exercise efficiently and comfortable.



Compact and durable frame from steel oval tubes

Rubber soles to protect the floor

Adjustable seating



Learn more about the IT70 line at www.amila.gr scan the QR-code

Muscle groups:
● Main ● Secondary

IT7014

Flat Bench

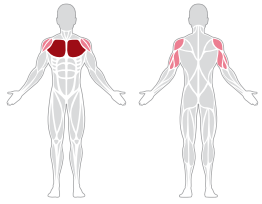

IT7014B



SPECIFICATIONS

Dimensions: 165,8x165,7x137,3 cm
 NET weight: 82 kg
 Category: F2

IT7015

Incline Bench

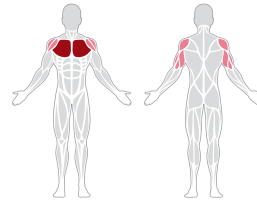

IT7015B



SPECIFICATIONS

Dimensions: 165,8x168,2x137,3 cm
 NET weight: 107 kg
 Category: F2

IT7016

Decline Bench

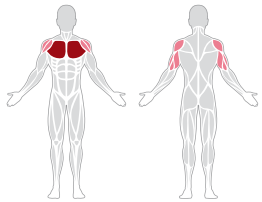

IT7016B



SPECIFICATIONS

Dimensions: 165,8x212,0x137,3 cm
 NET weight: 87 kg
 Category: F2

IT7019

Incline Row

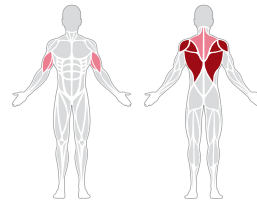

IT7019B



SPECIFICATIONS

Dimensions: 100,9x196,2x126,2 cm
 NET weight: 77,5 kg
 Weight capacity: 150 kg
 Category: F2

IT7031

Shoulder Bench Press

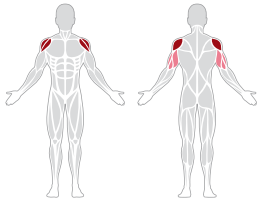

IT7031B



SPECIFICATIONS

Dimensions: 134,9x112,6x165,1 cm
 NET weight: 86,5 kg
 Weight capacity: 300 kg
 Category: F2

IT7002

Seated Preacher Curl

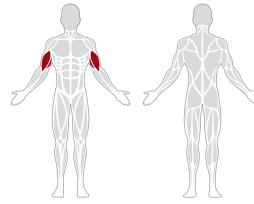

IT7002B



SPECIFICATIONS

Dimensions: 80,0x95,3x88,2 cm
 NET weight: 41 kg
 Category: F2

IT7010

Vertical Knee Raise / Dip Stand

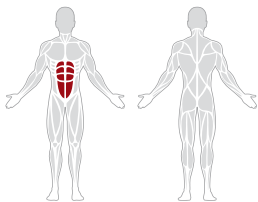

IT7010B



SPECIFICATIONS

Dimensions: 78,1x113,1x151,5 cm
 NET weight: 53 kg
 Category: F2

IT7010EOPT

Chin-Up Accessory

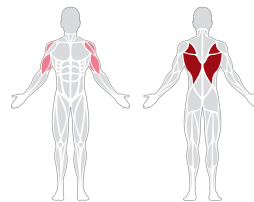

Add-on accessory
for IT7010



IT7010EOPTB



SPECIFICATIONS

Dimensions: 70,0x93,2x235,1 cm
 NET weight: 30,5 kg
 Category: F2

IT7013

Multi AB Bench

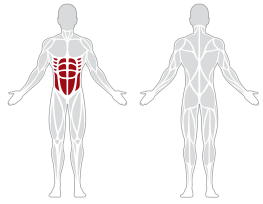

IT7003

AB Bench

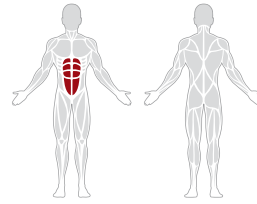

IT7013B



IT7003B

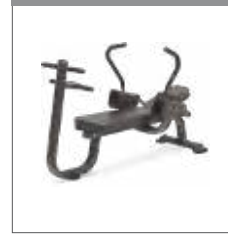

SPECIFICATIONS

Dimensions: 74,9x172,2x89,8 cm
NET weight: 42,5 kg
Category: F2

SPECIFICATIONS

Dimensions: 93,5x174,8x106,3 cm
NET weight: 57 kg
Category: F2

IT7030

Abdominal Bench

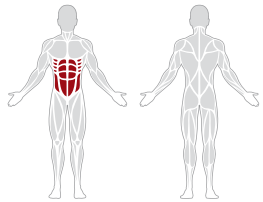

IT7007

Multi Hyperextension

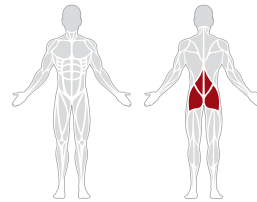

IT7030B



IT7007B

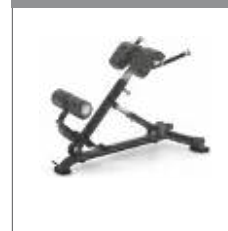

SPECIFICATIONS

Dimensions: 72,6x98,5x62,5 cm
NET weight: 35 kg
Category: F2

SPECIFICATIONS

Dimensions: 74,9x131,2x102,5 cm
NET weight: 43,5 kg
Category: F2

IT7006

Leg Press / Hack Squat

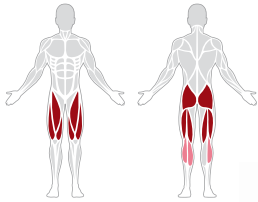

IT7006B



SPECIFICATIONS

Dimensions: 97,5x218,1x149,3 cm
 NET weight: 166 kg
 Weight capacity: 200 kg
 Category: F2

IT7020

45 Leg Press

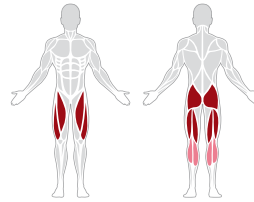

IT7020B



SPECIFICATIONS

Dimensions: 101,6x220,5x149,4 cm
 NET weight: 141 kg
 Weight capacity: 200 kg
 Category: F2

IT7005

Seated Calf Raise

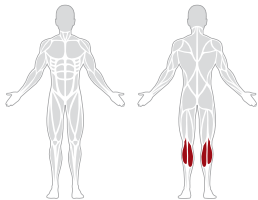

IT7005B



SPECIFICATIONS

Dimensions: 75,1x135,5x83,9 cm
 NET weight: 50 kg
 Weight capacity: 100 kg
 Category: F2

IT7004

Stretch

IT7004B



SPECIFICATIONS

Dimensions: 55,2x127,4x99,7 cm
 NET weight: 35 kg
 Category: F2

IT7009

Flat Bench



IT7009B



SPECIFICATIONS

Dimensions: 74,9x120,0x42,6 cm
 NET weight: 27,5 kg
 Category: F2

IT7011

Multi-Adjustable Bench



IT7011B



SPECIFICATIONS

Dimensions: 75,1x121,7x105,9 cm
 NET weight: 40 kg
 Category: F2

IT7001

Smith



IT7001B



SPECIFICATIONS

Dimensions: 224,1x132,6x237,0 cm
 NET weight: 178 kg
 Weight capacity: 200 kg
 Category: F2

IT7033

Max Rack



IT7033B



SPECIFICATIONS

Dimensions: 211,7x148,8x218,6 cm
 NET weight: 200 kg
 Weight capacity: 200 kg
 Category: F2

IT7012

Dumbbell Rack



IT7012B



SPECIFICATIONS

Dimensions: 158,0x81,4x98,2 cm
NET weight: 71 kg
Category: F2

IT7018

Dumbbell Rack



IT7018B



SPECIFICATIONS

Dimensions: 158,0x81,4x93,8 cm
NET weight: 68 kg
Category: F2

IT7027

Barbell Rack



IT7027B



SPECIFICATIONS

Dimensions: 91,9x94,9x161,2 cm
NET weight: 68,5 kg
Category: F2

IT7017

Weight Plate Tree



IT7017B

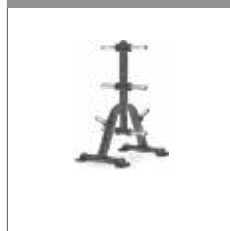

SPECIFICATIONS

Dimensions: 60,6x93,8x120,9 cm
NET weight: 26 kg
Category: F2

IT7032

Olympic Bar Rack



IT7032B



SPECIFICATIONS

Dimensions: 96,0x71,0x108,6 cm
NET weight: 47 kg
Weight capacity: 300 kg
Category: F2





ENCORE

The Complete Series

Encore line is suitable for Hotel gyms, Physical therapy centers, Hospitals, Personal training studios & Rehabilitation centers



Learn more about the Encore line at www.amila.gr scan the QR-code



ES3000

ES3000
3-station machine

» Can be combined with the
Hi / Lo Pulley Attachment
ES3000OPT
(p. 341)

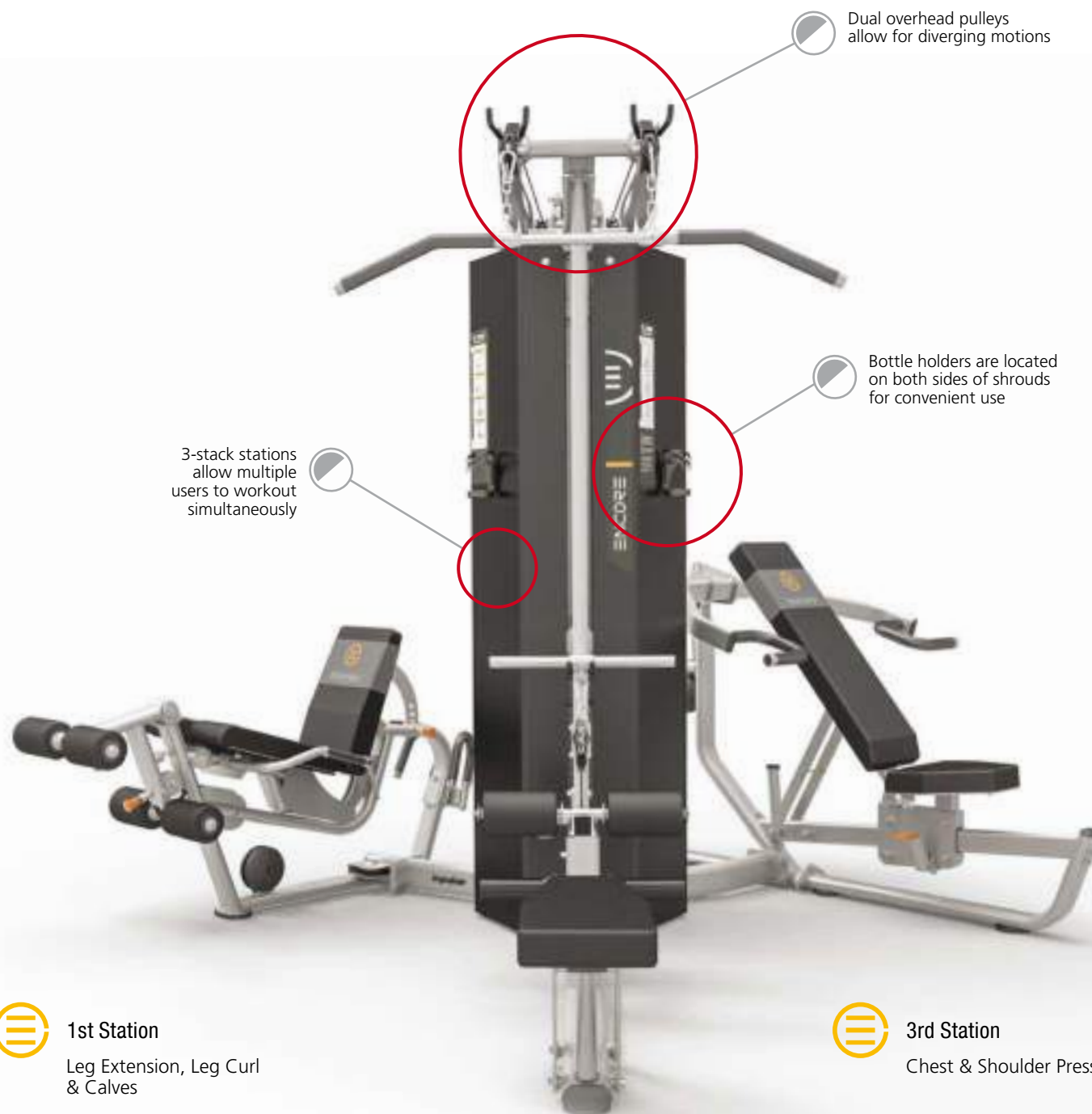

Dual overhead pulleys allow for diverging motions

Bottle holders are located on both sides of shrouds for convenient use

3-stack stations allow multiple users to workout simultaneously



1st Station

Leg Extension, Leg Curl & Calves



3rd Station

Chest & Shoulder Press



2nd Station

Lat Pulldown & Vertical Row

SPECIFICATIONS

Dimensions: 364,2x292,9x217,7 cm

NET weight: 300 kg

Weight stacks: 3x91 kg

Category: F2

ES2100

ES2100

Multi-Functional Trainer with Smith

» Accessories included:

- Handles (2 pcs)
- Triceps rope
- Dip arms
- Rowing foot pedal
- Short bar
- Barbell storage
- Ankle strap
- Support strap

» Can be combined with:

- ES2000OPT1**
(p. 341) and
- ES2000OPT2**
(p. 341)



SPECIFICATIONS

Dimensions: 192,5x144,7x218,0 cm
 NET weight: 186 kg
 Weight stacks: 2x91 kg
 Category: F2

ES9030

ES9030

Dual Pulley with Optional Bench

- » Accessories included
 - Handles (2 pcs)
 - Triceps rope
 - Leg ext/curl strap
 - Lat strap
 - Long bar retractable strap
- » Can be combined with bench
 - ES7011**
 - (p. 341)

31 vertical pulley positions for a large variety of different exercises

Chin-up/pull-up bar with ergonomic bends for regular grip, wide grip and reverse grip exercises.

Tablet stand



SPECIFICATIONS

Dimensions: 173,4x112,3x215,0 cm

NET weight: 150 kg

Weight stacks: 2x77 kg

Category: F2

ES3000OPT

- » Accessory for ES3000 (p. 338)
- » Quick installation, shares the stack with lat pull for saving space and cost
- » 31 vertical pulley positions for a large variety of different exercises



Hi / Lo Pulley Attachment

SPECIFICATIONS

Dimensions: 37,6x81,9x214,5 cm
 NET weight: 26,5 kg
 Category: F2

ES7011

- » Can be combined with ES9030 (p. 340)

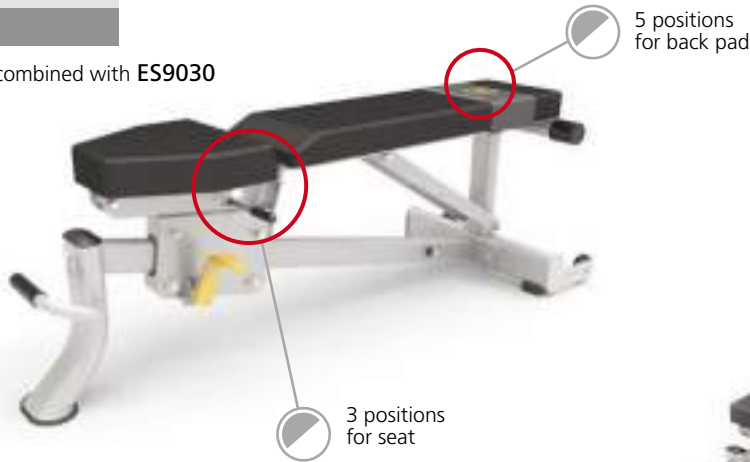

Bench

SPECIFICATIONS

Dimensions: 52,5x144,0x49,0 cm
 NET weight: 34,5 kg
 Category: F2

ES2000OPT1

- » Accessory for ES2100 (p. 339)

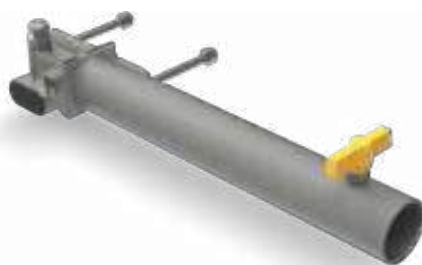

Pivot

ES2000OPT2

- » Accessory for ES2100 (p. 339)



Pull Down Bar + Roller

SPECIFICATIONS

Dimensions: 50,0x15,0x18,0 cm
 NET weight: 6,2 kg
 Category: F2

SPECIFICATIONS

Dimensions: 126,5x25,5x13,0 cm
 NET weight: 4,5 kg
 Category: F2

ECU7

ECU7



SPECIFICATIONS

Dimensions: 62,8x113,2x147,2 cm
 NET weight: 67 kg
 Disk: 8 kg
 Resistance: 20 levels
 MAX user weight: 150 kg
 Category: F2

ECR7

ECR7



SPECIFICATIONS

Dimensions: 64,2x167,1x131,9 cm
 NET weight: 83 kg
 Disk: 8 kg
 Resistance: 20 levels
 MAX user weight: 150 kg
 Category: F2

ECE5

ECE5



SPECIFICATIONS

Dimensions: 81,2x184,9x178,0 cm
 NET weight: 120 kg
 Disk: 8 kg
 Resistance: 20 levels
 MAX user weight: 150 kg
 Category: F2

ECT7

ECT7

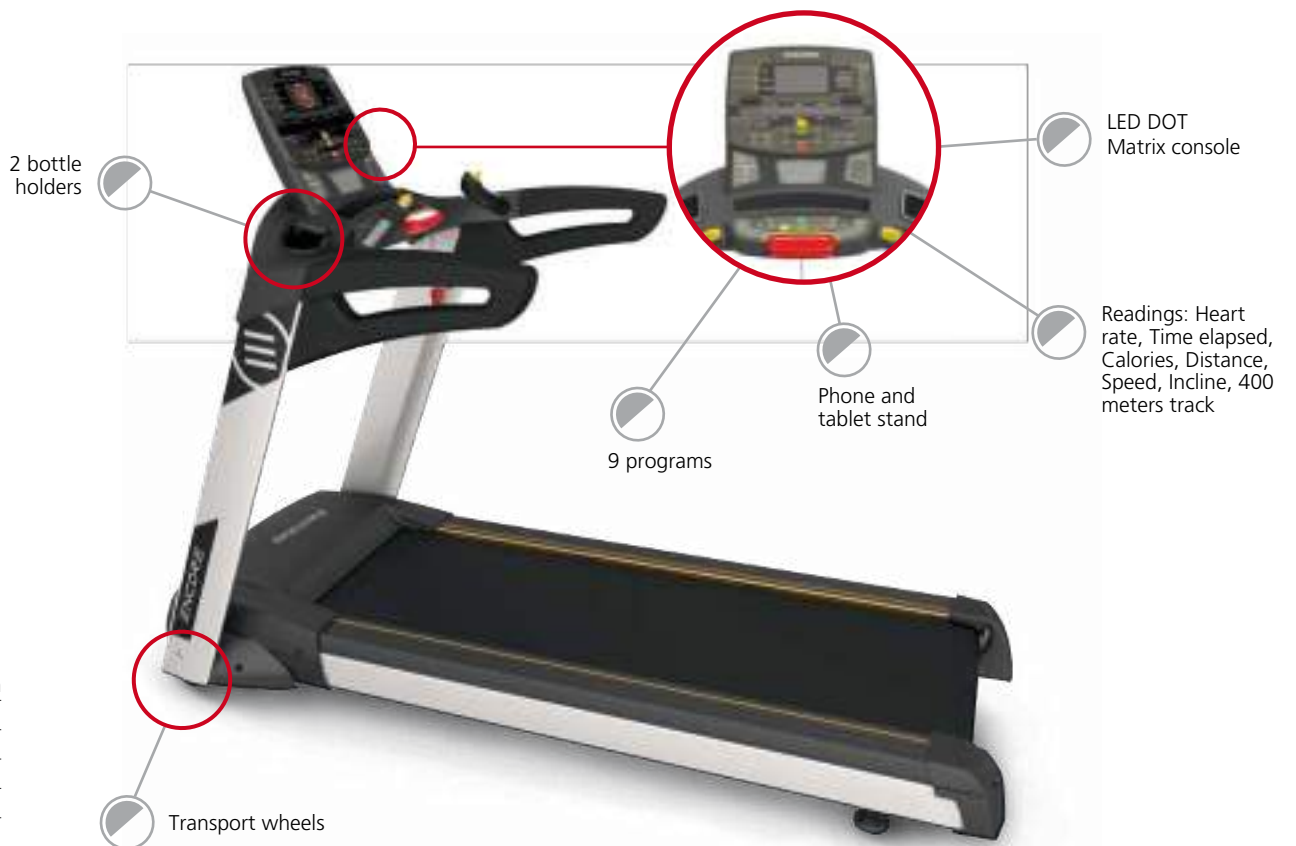
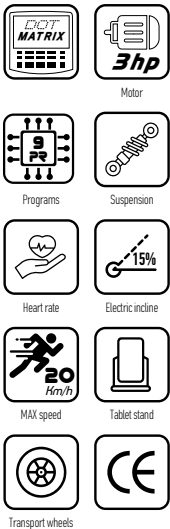

SPECIFICATIONS

Dimensions: 94,0x205,1x145,9 cm
 NET weight: 150 kg
 Motor: 3hp
 MAX speed: 20 Km/h
 Incline: Electronic 15%
 Running surface: 51,0x152,5 cm
 MAX user weight: 160 kg
 Category: F2

in impulse PL Line

The clear and precise instructions and training tips are great for individuals who are new to strength training and help users to build targeted muscles



PL line consists of high quality machines, utilizing two or more functions, intended for high commercial use, with attractive design.

The user friendly design simplifies exercising and makes it more efficient and comfortable.



Nylon pulleys, reinforced with glass fibers and deep notches, offer safe and smooth movement of the cable

Ergonomically designed grips with aluminum caps for a more refined look

Ergonomic 70mm thick pads

Stainless steel seat adjustment that provides a longer service life, easy to adjust and looks beautiful



Learn more about the PL line at www.amila.gr scan the QR-code

The weight stack is not included in the price

Muscle groups:
● Main ● Secondary

PL9022

Rear Deltoid / Pectoral Fly

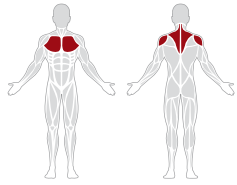

SPECIFICATIONS

Dimensions: 129,9x136,5x206,1 cm
 NET weight: 107 kg
 Category: F2

PL9021

Multi Press

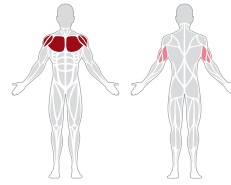

SPECIFICATIONS

Dimensions: 132,4x193,2x152,0 cm
 NET weight: 112 kg
 Category: F2

PL9002

Lat Pulldown / Seated Row

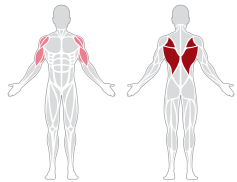

SPECIFICATIONS

Dimensions: 102,0x176,5x218,2 cm
 NET weight: 90,5 kg
 Category: F2

PL9024

Ab / Low Back

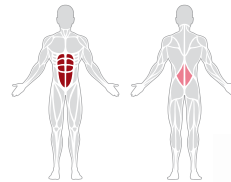

SPECIFICATIONS

Dimensions: 109,9x104,4x152,0 cm
 NET weight: 107 kg
 Category: F2

PL9016

Inner / Outer Thigh

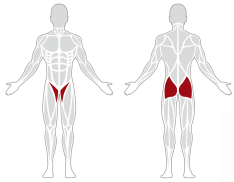

SPECIFICATIONS

Dimensions: 173,9x160,9x152,0 cm
 NET weight: 99 kg
 Category: F2

PL9019

Leg Extension / Leg Curl

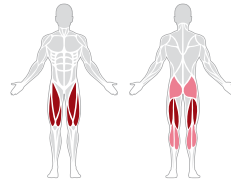

SPECIFICATIONS

Dimensions: 124,5x146,5x152,0 cm
 NET weight: 116 kg
 Category: F2

PL9010

Leg Press / Calf Raise

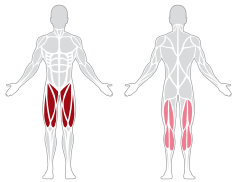

SPECIFICATIONS

Dimensions: 114,7x216,5x152,0 cm
 NET weight: 111 kg
 Category: F2

PLWS170

Weight Stack

» Weight: 77Kg/170Lbs

PLWS250

» Weight: 113Kg/250Lbs



in impulse

IT93 Line

Full-height
translucent
shroud on both
sides

Ergonomically designed TPU
grips with aluminum caps
for a more refined look

Ergonomic seat, back
and chest cushions

When the IT93 line was first introduced, revolutionized sports equipment with huge innovations, due to its meticulous in every detail design, its construction quality and luxurious appearance.

Today, although Impulse has produced much better series, such as FE97 and IT95, the IT93 series still remains an attractive buy, because of its timeless design and its comparatively lower price.



Diverging motion structure allows the arm training simultaneously and alternately

Concise and easy to read exercise placards offer a quick reference to targeted muscle groups and proper machine use

All moving part incorporate high quality bearings ensuring smooth motion

Lathed pulley with less tolerance



Learn more about the IT93 line at www.amila.gr scan the QR-code

Muscle groups:
● Main ● Secondary

46161

Chest Press

IT9301

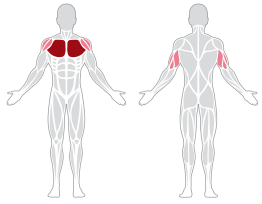

SPECIFICATIONS

Dimensions: 141,2x153,6x149,0 cm

NET weight: 128 kg

Weight stack: 91 kg

Category: F2

46170

Weight Assisted Chin / Dip Combo

IT9320

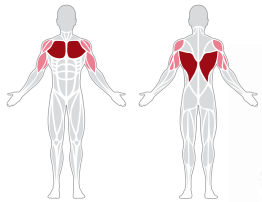

SPECIFICATIONS

Dimensions: 117,8x133,2x228,7 cm

NET weight: 151 kg

Weight stack: 91 kg

Category: F2

46254

Lat Pull

IT9302

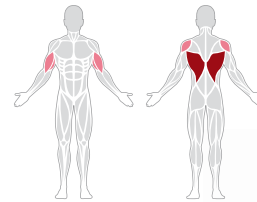

SPECIFICATIONS

Dimensions: 137,5x145,1x190,0 cm

NET weight: 141 kg

Weight stack: 91 kg

Category: F2

46157

Abdominal
IT9314

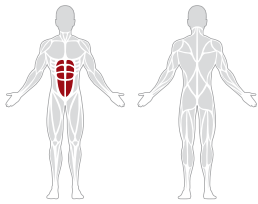

SPECIFICATIONS

Dimensions: 116,3x153,3x156,1 cm
NET weight: 130 kg
Weight stack: 91 kg
Category: F2

46158

Torso Rotation
IT9318

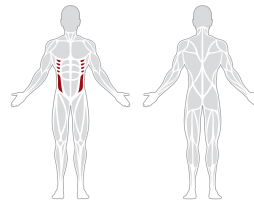

SPECIFICATIONS

Dimensions: 126,2x124,0x149,0 cm
NET weight: 139 kg
Weight stack: 91 kg
Category: F2

4616301

Total Hip
IT9309

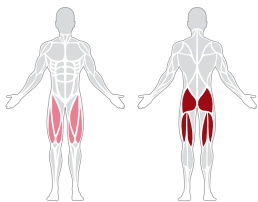

SPECIFICATIONS

Dimensions: 97,4x132,5x149,0 cm
NET weight: 141 kg
Weight stack: 125 kg
Category: F2

46145

Seated Leg Curl
IT9306

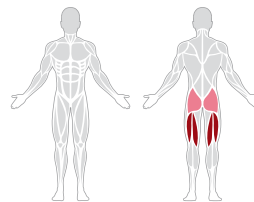

SPECIFICATIONS

Dimensions: 116,2x163,0x149,0 cm
NET weight: 147 kg
Weight stack: 91 kg
Category: F2

4616501

Leg Extension
IT9305

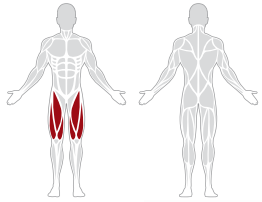

SPECIFICATIONS

Dimensions: 118,1x133,9x149,0 cm
NET weight: 129 kg
Weight stack: 125 kg
Category: F2

46160

Rotary Calf
IT9316

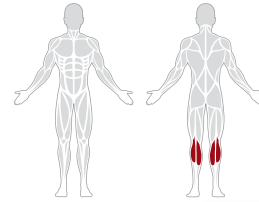

SPECIFICATIONS

Dimensions: 121,2x167,9x149,0 cm
NET weight: 131 kg
Weight stack: 91 kg
Category: F2

46187

SPECIFICATIONS

Dimensions: 209,0x335x232,9 cm
NET weight: 313 kg
Weight stack: 4x91 kg
Category: F2

4618701

SPECIFICATIONS

Dimensions: 209,0x335x232,9 cm
NET weight: 313 kg
Weight stack: 4x125 kg
Category: F2



4 Stack Station
IT9327

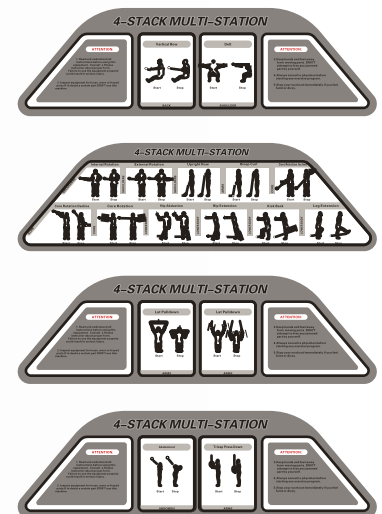

in *impulse*

IFP Line



IFP line consists of machines for various muscle groups, such as chest, shoulders, back, legs and arms. It is strictly designed according to parameters as human mechanics and muscle strength lines. The included machines can perform different functions and exercise different muscle groups.

Without decreasing the functionality of the machines, IFP line requires less space due to their structural design, so that more machines can fit in a given space.

Disk placement
to change the
resistance

Safety
limiters

Auxiliary
handles

Plate storage

Ergonomic
pads



Learn more about the IFP line at
www.amila.gr scan the QR-code

Muscle groups:

● Main ● Secondary

IFP1101

Seated Shoulder Press

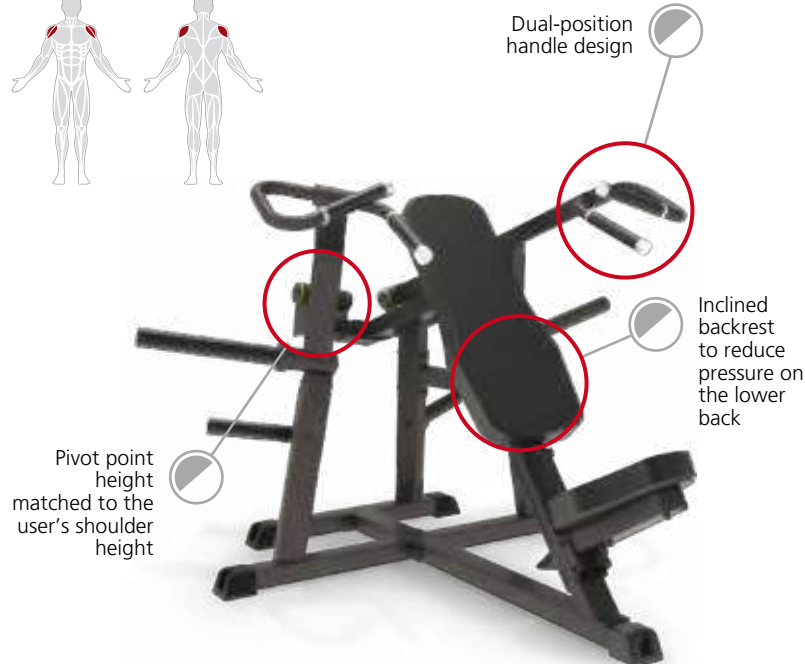
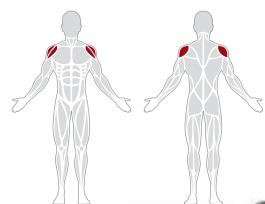

SPECIFICATIONS

Dimensions: 157,9x152,0x106,9 cm
 NET weight: 87,0 kg
 Weight capacity: 300 kg
 Category: F2

IFP1201

Seated Chest Press

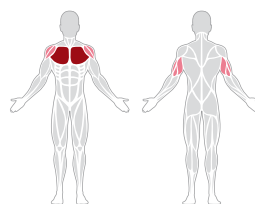

SPECIFICATIONS

Dimensions: 127,6x98,4x124,8 cm
 NET weight: 64,2 kg
 Weight capacity: 200 kg
 Category: F2

IFP1206

Standing Chest Fly

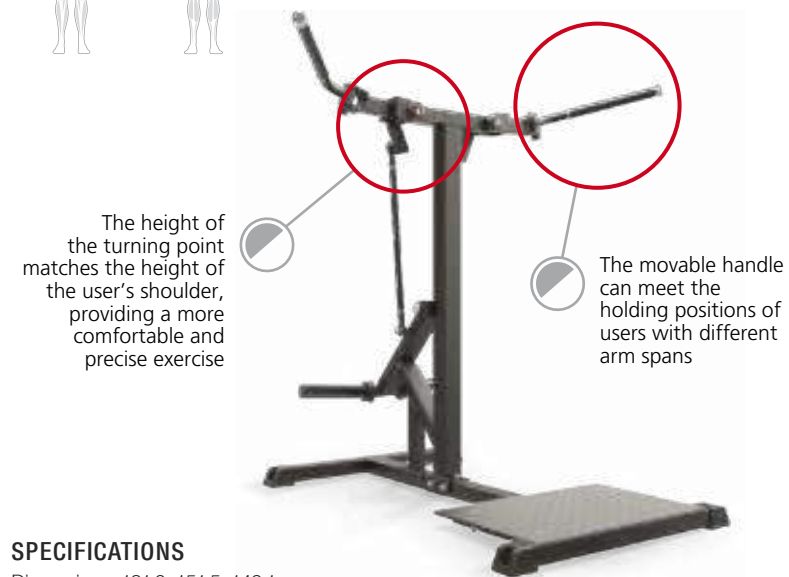
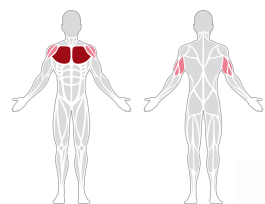

SPECIFICATIONS

Dimensions: 131,0x151,5x149,1 cm
 NET weight: 70 kg
 Weight capacity: 200 kg
 Category: F2

IFP1103

Standing Lateral Raise

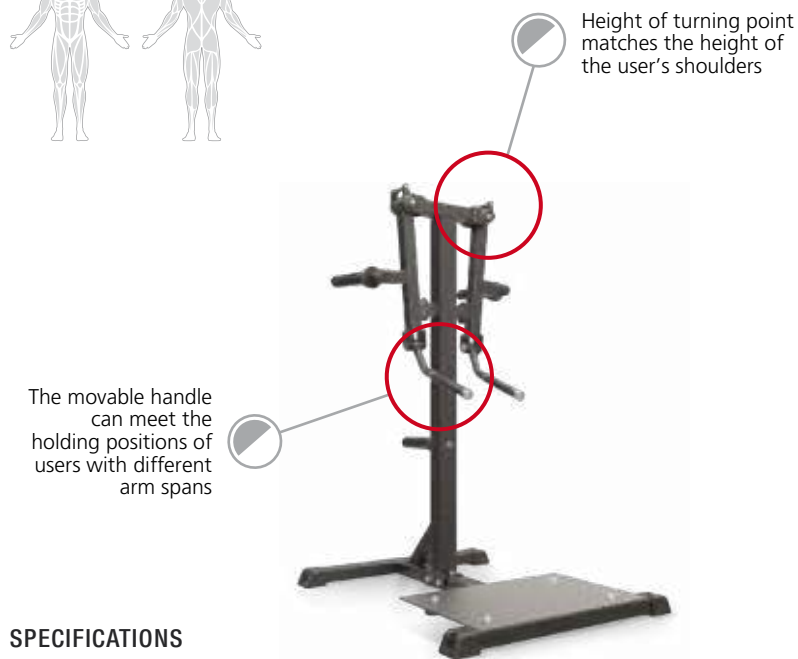
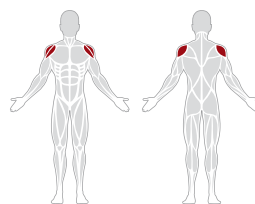

SPECIFICATIONS

Dimensions: 116,5x88,5x155,0 cm
 NET weight: 57,3 kg
 Weight capacity: 200 kg
 Category: F2

IFP1706

Biceps / Triceps

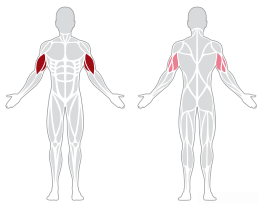

Short bar for bicep curl training



Inclined back pad for greater back support

Seat adjustable by tooth plate

SPECIFICATIONS

Dimensions: 70,8x109,2x128,7 cm
 NET weight: 47,3 kg
 Weight capacity: 200 kg
 Category: F2

IFP1501

Bicep Curl

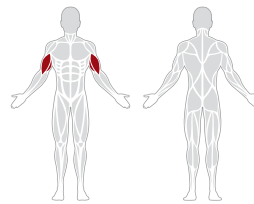

Seat easily adjustable with one hand



The belt-connected resistance system follows the muscle strength curve

Highly ergonomic inward angle of the handles

SPECIFICATIONS

Dimensions: 130,2x70,7x98,8 cm
 NET weight: 56,0 kg
 Weight capacity: 200 kg
 Category: F2

IFP1301

Lat Pulldown

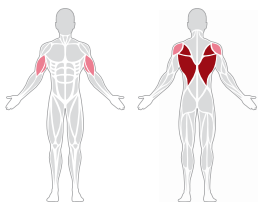

Movable handle makes the wrist more comfortable

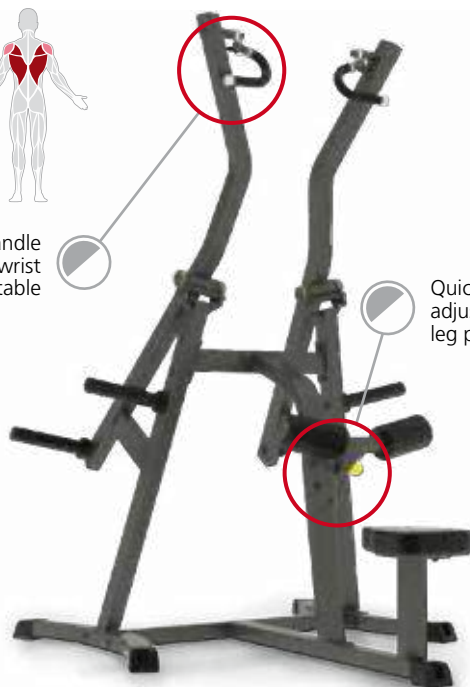

Quick-release adjustment for the leg pad height

SPECIFICATIONS

Dimensions: 170,3x133,9x204,7 cm
 NET weight: 95,0 kg
 Weight capacity: 200 kg
 Category: F2

IFP1302

Seated Row

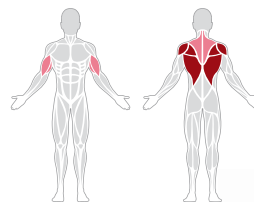

Diverging split-motion training track



Seat adjustable by tooth plate

Auxiliary pedals to get on and off the machine

SPECIFICATIONS

Dimensions: 102,0x147,0x134,0 cm
 NET weight: 77,5 kg
 Weight capacity: 200 kg
 Category: F2

IFP1305

T-Bar Row

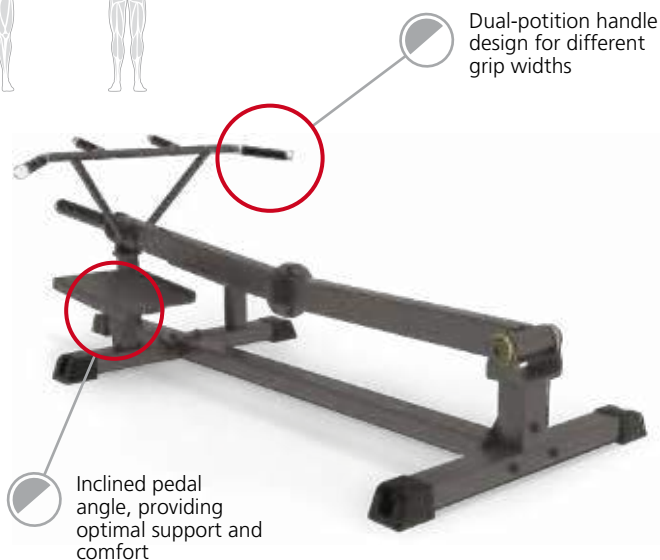
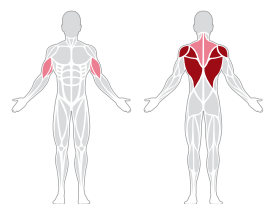

SPECIFICATIONS

Dimensions: 207,9x90,8x63,5 cm
 NET weight: 23,0 kg
 Weight capacity: 150 kg
 Category: F2

IFP1721

Half Cage / Smith Machine

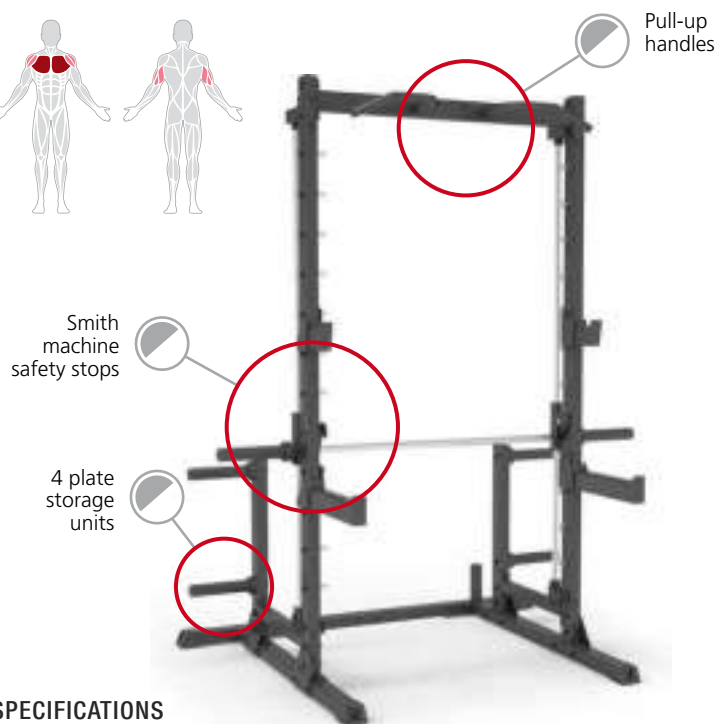
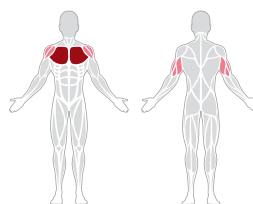

SPECIFICATIONS

Dimensions: 185,0x140,4x234,3 cm
 NET weight: 77,5 kg
 Weight capacity: 250 kg
 Category: F2

IFP1721OPT

**Lat Pulldown
Seated Row Attachment**

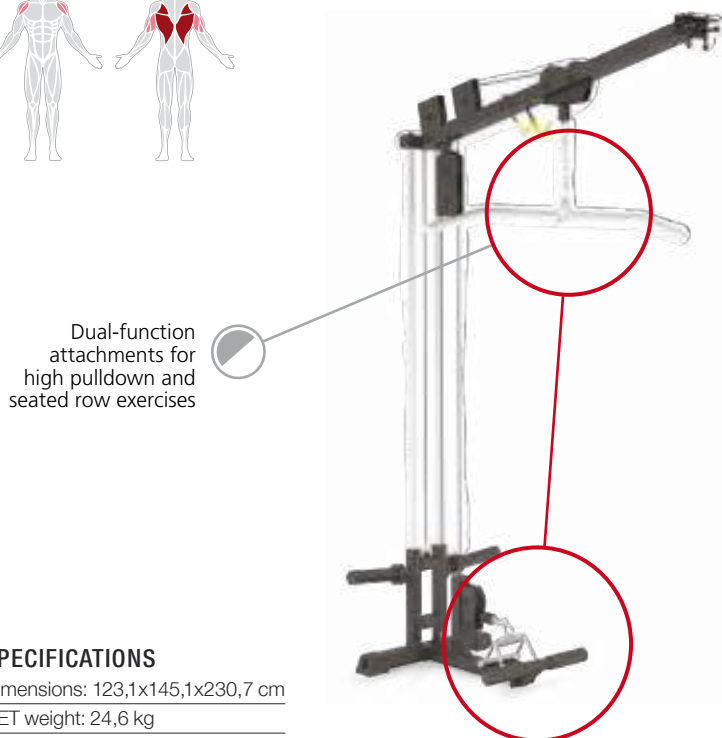
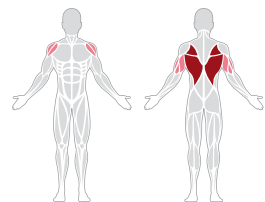

SPECIFICATIONS

Dimensions: 123,1x145,1x230,7 cm
 NET weight: 24,6 kg
 Weight capacity: 200 kg
 Category: F2

IFP1616

Vertical Hip Thrust

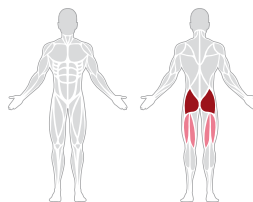

SPECIFICATIONS

Dimensions: 122,0x109,8x116,5 cm
 NET weight: 67,5 kg
 Weight capacity: 150 kg
 Category: F2

IFP1619

Reverse Hyperextension

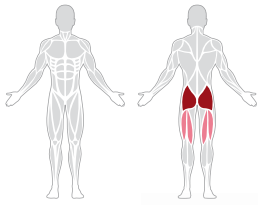

SPECIFICATIONS

Dimensions: 79,7x131,0x115,3 cm
 NET weight: 66,0 kg
 Weight capacity: 100 kg
 Category: F2

IFP1622

Standing Hip Abductor

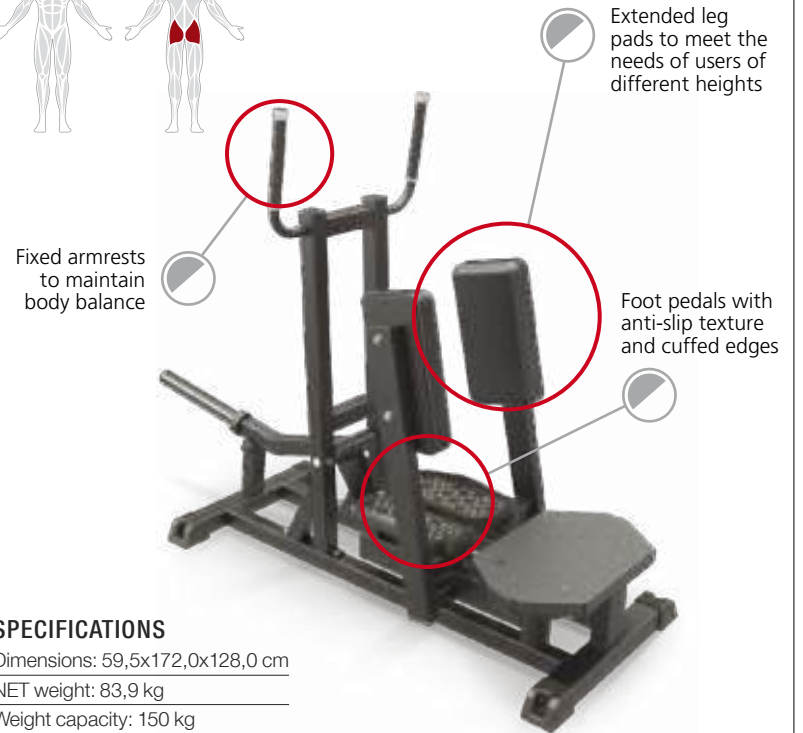
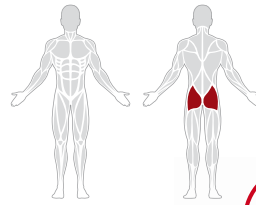

SPECIFICATIONS

Dimensions: 59,5x172,0x128,0 cm
 NET weight: 83,9 kg
 Weight capacity: 150 kg
 Category: F2

IFP1604

Prone Leg Curl

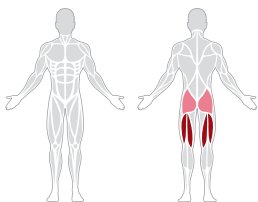

SPECIFICATIONS

Dimensions: 120,2x162,3x79,8 cm
 NET weight: 75,5 kg
 Weight capacity: 150 kg
 Category: F2

IFP1605

Seated Leg Extension

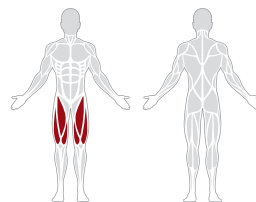

SPECIFICATIONS

Dimensions: 117,3x124,6x99,5 cm
 NET weight: 63,4 kg
 Weight capacity: 150 kg
 Category: F2

IFP1623

Seated Calf Raise

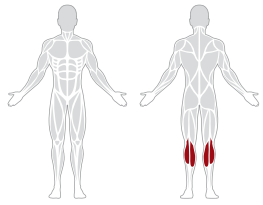

SPECIFICATIONS

Dimensions: 56,6x136,8x84,9 cm
 NET weight: 38,5 kg
 Weight capacity: 100 kg
 Category: F2

IFP1707

Leverage Squat / Calf

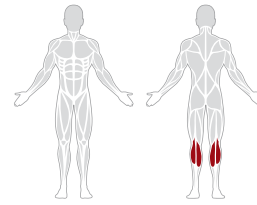

SPECIFICATIONS

Dimensions: 144,5x149,0x155,0 cm
 NET weight: 115,5 kg
 Weight capacity: 350 kg
 Category: F2

IFP1613

Vertical Leg Press

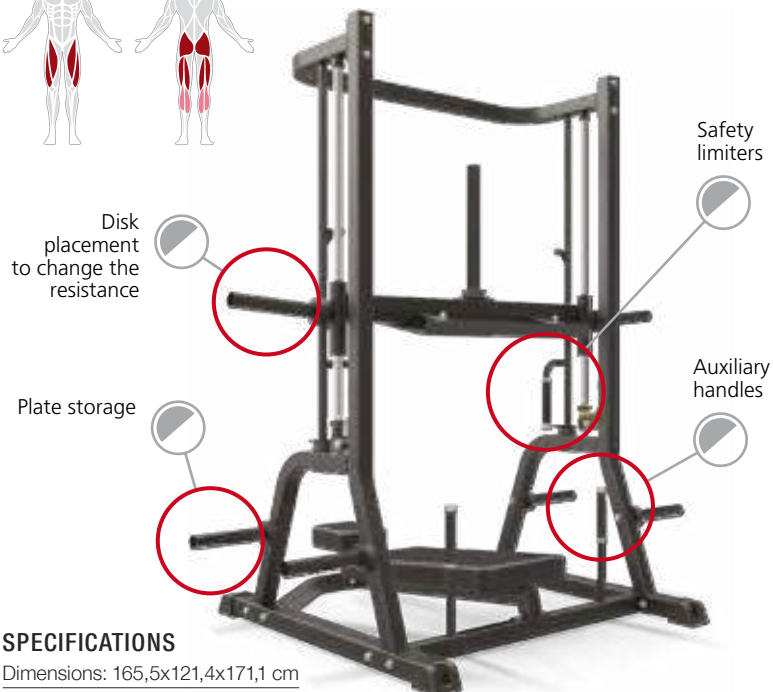
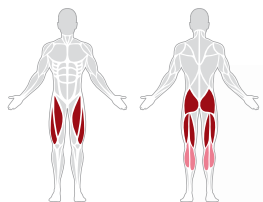

SPECIFICATIONS

Dimensions: 165,5x121,4x171,1 cm
 NET weight: 110,4 kg
 Weight capacity: 350 kg
 Category: F2

IFP1615

Belt Squat

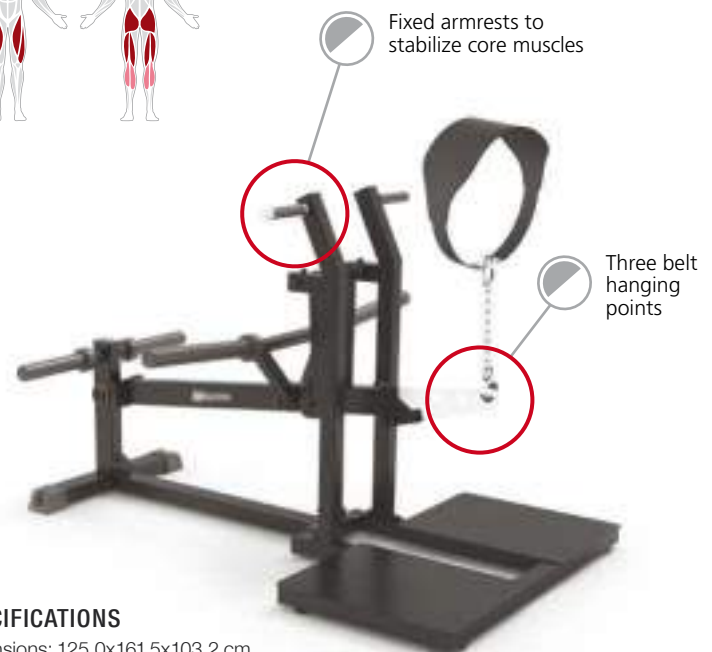
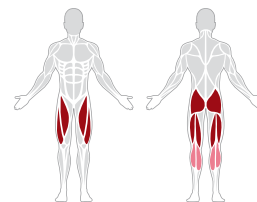

SPECIFICATIONS

Dimensions: 125,0x161,5x103,2 cm
 NET weight: 77,5 kg
 Weight capacity: 350 kg
 Category: F2

IFP1617

Hack Squat

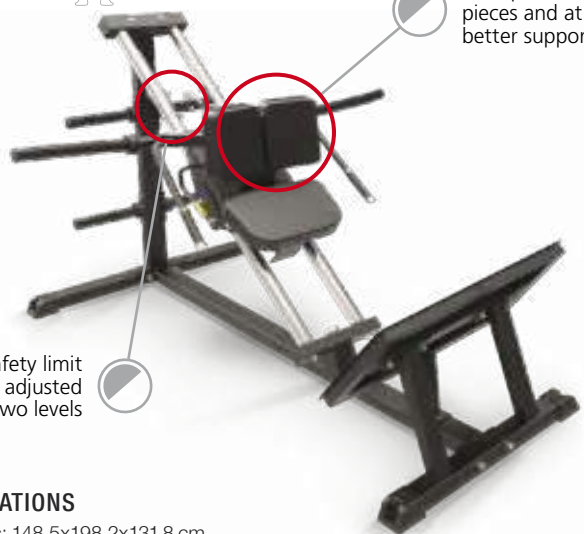
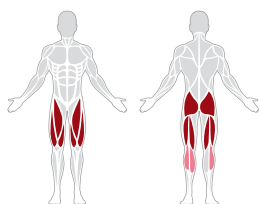

Back pad divided in two pieces and at an angle to better support the back

The safety limit can be adjusted to two levels

SPECIFICATIONS

Dimensions: 148,5x198,2x131,8 cm
 NET weight: 100,6 kg
 Weight capacity: 350 kg
 Category: F2

IFP1711

Hack Squat / Leg Press

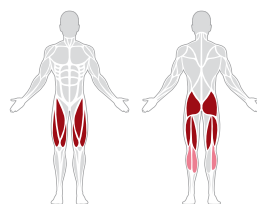

Both the foot pedal and shoulder pads can be folded and retracted with one hand to easily switch between the two functions

Foot pedal angle adjustment can be operated with one hand

Safety handles

SPECIFICATIONS

Dimensions: 102,0x263,4x137,3 cm
 NET weight: 150,5 kg
 Weight capacity: 350 kg
 Category: F2



CODE



PRICE



NAME

















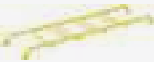



DIMENSIONS (cm)









PAGE















IZ Line (I-Zone)







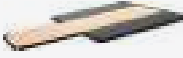
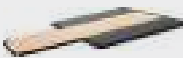









	IZ7001		Stretching	165,5 × 168,3 × 236,4	263
	IZ7002		Box	165,5 × 112,6 × 239,0	263
	IZ7003		Rebound	165,5 × 107,2 × 234,0	263
	IZ7004		Half Rack	174,7 × 140,9 × 244,3	263
	IZ7005		Dap	182,6 × 75,6 × 236,5	264
	IZ7006		Connector	152,8 × 17,8 × 20,5	264
	IZ7007		Stair 2	285,0 × 111,7 × 20,4	265
	IZ7008		Stair 1	351,0 × 101,0 × 20,5	265
	IZ7009		Step Attachment	75,0 × 65,0 × 28,9	265
	IZ7010		Dip Attachment	94,0 × 62,4 × 28,9	265
	IZ7011		“S” Joint	17,8 × 10,0 × 5,0	264

				
CODE	PRICE	NAME	DIMENSIONS (cm)	PAGE
	IZ7012	Pivot	53,1 × 12,6 × 17,8	265
	IZ7014	Stair	243,5 × 120,7 × 20,5 .	265
	IZ7015	Stair	240,6 × 170,4 × 20,5 .	265
	IZ7017	Battle Rope Reel	65,0 × 65,0 .	265

MS Line (Mega Space)

	MS00	Stand - Single Storage	179,0 × 60,9 × 261,4 .	269
	MS01	Half Rack	137,7 × 126,1 × 261,4 .	269
	MS02	Power Rack	137,7 × 230,6 × 261,4 .	269
	MS11	LAT Pulldown / Vertical Row	122,6 × 216,0 × 259,6 .	268
	MS12	Functional Cable Pulley	49,6 × 131,3 × 259,9 .	268
	MS13	Jammer Arms	87,5 × 36,9 × 139,5 .	270
	MS14	Belt Squat	111,2 × 55,0 × 67,7 .	272

				
CODE	PRICE	NAME	DIMENSIONS (cm)	PAGE
	MS15	Endless Rope Trainer	26,6 × 52,7 × 53,7 .	270
	MS21	Rack Connected Bridge	205,6 × 24,0 × 19,2 .	271
	MS22	Rack Connected Bridge	275,6 × 24,0 × 19,2 .	271
	MS23	Bumper Plate Storage Connector Between Rack	212,0 × 38,5 × 28,6 .	271
	MS24	Kettlebell Storage Connector Between Rack	212,0 × 44,1 × 10,7 .	271
	MS25	Ball Storage Connector Between Rack	212,0 × 38,5 × 10,8 .	271
	MS26	Dumbbell Storage Connector Between Rack	212,0 × 38,5 × 227,0 .	271
	MS27	Side Storage	99,5 × 41,6 × 76,3 .	272
	MS31	Platform	244,6 × 342,1 × 5,0 .	270
	MS32	Platform	257,6 × 382,5 × 5,4 .	270
	MS41	Side Storage	134,0 × 40,0 × 7,7 .	273
	MS43	Adjustable Utility Pins	59,0 .	273

				
CODE	PRICE	NAME	DIMENSIONS (cm)	PAGE
	MS44	Barbell-Utility Platform Storage Attachment	28,0 × 24,0 × 18,0 .	272
	MS45	Foam Roller Pads	55,9 .	273
	HSPCF28	Multi Angle Pull Up Handle	114,3 × 32,4 × 10,9 .	279
	HSPCF29	Triphasic Training Arms	72,1 × 108,1 × 10,5 .	271
	HSPCF42	Tricep Dip Attachment	64,9 × 77,9 × 25,0	272
	HSPCF47	Resistant Band Anchor	30,5 .	273
	HSPCF49	Safety Straps	115,0 × 5,0 × 1,0 .	273
	HSPCF51	Battle Rope Anchor	7,0 × 15,2 × 18,0 .	273
	HSPCF52	Landmine Rack Attachment	12,6 × 53,0 × 24,0 .	272
	HSPCF54	J Hook Attachment	22,4 × 29,6 × 22,4 .	273
	HSPCF59	Ball Grip Attachment	20,7 × 20,9 × 7,6 .	273
	IZCFA12	Wall Ball Target	55,0 × 24,6 × 60,8 .	272



CODE



PRICE



NAME



DIMENSIONS (cm)



PAGE



IZCFA16

Heavy Bag Hanger

96,3 × 76,2 × 6,0 .

271

SE Series (Sterling Elite)



SE5001

Half Rack

133,8 × 130,1 × 247,6 .

277



SE5002

Power Rack

133,8 × 196,8 × 247,6 .

277



SE5011

Stand-Single Storage

184,2 × 56,3 × 246,6 .

277



SE5012

Combo Storage-Single

184,2 × 103,1 × 246,6 .

277

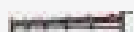

SE5021

Rack Connector / Multi-Grip

190,0 × 22,5 × 23,0 .

278



SE5022

Rack Connector-Thick Straight

190,0 × 7,6 × 23,0 .

278

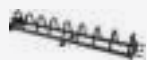

SE5023

Bumper Plate Storage Connector

190,0 × 7,6 × 23,0 .

278



SE5024

Free Storage Connector

190,0 × 43,2 × 17,1 .

278



SE5025

Ball Storage Connector

190,0 × 28,0 × 26,0 .

278



SE5041

Band Pegs

32,5 × 10,1 × 5,0 .

279

CODE

PRICE

NAME

DIMENSIONS (cm)

PAGE

	SE5042		Reverse J-Hooks	9,5 × 25,2 × 25,0 .	279
	SE5043		Spotter Stands	40,0 × 23,5 × 44,2 .	278
	HZ7008		Battle Rope Attachment	17,8 × 12,9 × 6,0 .	279
	HZ7009		Step Attachment	66,1 × 77,3 × 33,8 .	279
	HZ7010		Dip Attachment	62,5 × 94,6 × 33,9 .	279
	IZ7012		Landmine Rack Attachment	12,6 × 53,0 × 28,9 .	279

















HZ Line (H-Zone)

















	HZ7001		Power Rack Station	173,7 × 172,3 × 255,8 .	285
	HZ7002		Hi-Low Pulley Station	110,6 × 110,9 × 241,3 .	285
	HZ7003		Multi-Function Station	114,2 × 112,3 × 241,1 .	285
	HZ7004		Multi-Function Connector	228,4 × 45,3 × 20,3 .	285
	HZ7006		Wall Connector	86,6 × 20,0 × 7,5 .	285

















	CODE	PRICE	NAME	DIMENSIONS (cm)	PAGE
	HZ7008		Battle Rope Attachment	17,8 × 12,9 × 6,0 .	284
	HZ7009		Step Attachment	66,1 × 77,3 × 33,8 .	284
	HZ7010		Dip Attachment	62,5 × 94,6 × 33,9 .	284
	IZ7012		Pivot	12,6 × 53,0 × 28,9 .	284

SL Line

	SL7001		Chest Press	198,0 × 137,5 × 171,8	288
	SL7002		Pulldown	140,8 × 165,9 × 197,3	288
	SL7003		Shoulder Press	175,4 × 154,5 × 148,2	288
	SL7004		Low Row	152,6 × 176,1 × 165,2	288
	SL7005		Incline Chest Press	207,2 × 152,3 × 176,5	289
	SL7006		Leg Press	142,1 × 226,6 × 141,5	291
	SL7007		Row	145,0 × 181,5 × 133,4	289

 CODE	 PRICE	 NAME	 DIMENSIONS (cm)	 PAGE
	SL7008	Rear Kick	129,9 × 1680 × 163,8	293
	SL7009	Power Rack	149,9 × 203,1 × 227,8	296
	SL7009OPT	Weight Platre Rack Option	167,3 × 71,7 × 219,9	296
	SL7010	Plate Rack	62,8 × 90,3 × 123,9	299
	SL7011	FID Bench	63,9 × 150,2 × 114,8	298
	SL7012	FI Bench	63,9 × 154,4 × 99,2	298
	SL7013	Glute Ham Bench	89,9 × 155,9 × 148,2	293
	SL7014	Half Rack	174,6 × 139,9 × 244,2	297
	SL7015	Full Rack	174,6 × 196,6 × 244,2	297
	SL7016	Dumbbell Rack	225,8 × 75,9 × 73,8	299
	SL7017	Seated Calf Raise	75,7 × 147,5 × 84,4	292
	SL7018	Arm Curl	86,0 × 113,6 × 101,6	298

 CODE	 PRICE	 NAME	 DIMENSIONS (cm)	 PAGE
	SL7019		Incline Row 104,8 × 196,3 × 126,2	290
	SL7020		Reverse Leg Press 193,3 × 246,1 × 153,4	291
	SL7021		Hack Squat 188,0 × 220,6 × 128,6	291
	SL7022		Utility Bench 63,1 × 119,0 × 82,2	299
	SL7023		Bicep Curl 104,5 × 149,4 × 119,9	290
	SL7024		Tricep Dip 157,8 × 173,1 × 120,4	289
	SL7025		Leg Extension 169,0 × 134,5 × 103,7	291
	SL7026		Leg Curl 130,0 × 152,7 × 140,6	292
	SL7028		Flat Bench 173,8 × 191,0 × 131,5	294
	SL7029		Incline Bench 171,8 × 205,9 × 149,6	294
	SL7030		Decline Bench 171,8 × 237,0 × 131,5	294
	SL7031		Shoulder Bench Press 171,9 × 126,1 × 192,0	293

 CODE	 PRICE	 NAME	 DIMENSIONS (cm)	 PAGE
	SL7032	Standing Calf Raise	160,5 × 148,5 × 181,3	290
	SL7034	Squat	155,5 × 230,2 × 126,6	290
	SL7035	Flat Bench	63,0 × 128,1 × 42,6	298
	SL7036	Abdominal	134,4 × 126,7 × 164,2	295
	SL7038	Total Hip	160,8 × 161,8 × 110,6	292
	SL7040	Squat Lunge	169,4 × 166,8 × 63,6	292
	SL7041	Super Olympic Bench	241,0 × 174,3 × 162,2	294
	SL7042	Magic Rack / Smith Machine	227,4 × 231,4 × 238,6	296
	SL7043	Multi AB Bench	63,0 × 172,2 × 91,2	295
	SL7045	Vertical Knees Raise / Dip Stand	76,5 × 118,9 × 153,7	295
	SL7045OPT	Chin-up and Dip	113,0 × 118,9 × 238,7	295
	SL7046	Iso-Lateral Super Chest Press	217,1 × 249,2 × 113,2	289

	CODE				
	SL7047		Multi Hyper Extension	94,7 × 134,0 × 87,2	293

FE Line (EXOFORM)

	FE9701		Chest Press	156,5 × 122,9 × 149,0	302
	FE9701B				
	FE9702		Lat Pulldown	130,4 × 122,6 × 210,9	303
	FE9702B				
	FE9703		Arm Curl	156,7 × 114,9 × 149,0	302
	FE9703B				
	FE9705		Leg Extension	124,0 × 149,2 × 149,0	304
	FE9705B				
	FE9706		Seated Leg Curl	124,0 × 154,1 × 148,8	304
	FE9706B				

	 CODE	 PRICE	 NAME	 DIMENSIONS (cm)	 PAGE
	FE9708		Abductor-Adductor	151,4 × 172,7 × 148,8	305
	FE9708B				
	FE9710		Leg Press	134,8 × 178,6 × 148,9	305
	FE9710B				
	FE9712		Shoulder Press	142,2 × 176,5 × 149,0	302
	FE9712B				
	FE9714		Abdominal	120,2 × 138,3 × 149,1	304
	FE9714B				
	FE9715		Pec Fly / Rear Delt	172,1 × 134,0 × 149,0	302
	FE9715B				
	FE9716		Calf Raise	118,7 × 123,0 × 174,5	305
	FE9716B				

 CODE	 PRICE	 NAME	 DIMENSIONS (cm)	 PAGE	
	FE9719		Row	112,7 × 199,6 × 149,2	303
	FE9719B				
	FE9720		Weight Assisted Chin / Dip Combo	175,0 × 138,0 × 219,8	303
	FE9720B				
	FE9721		Prone Leg Curl	119,3 × 170,5 × 149,2	306
	FE9721B				
	FE9723		Tricep	158,0 × 114,9 × 149,0	303
	FE9723B				
	FE9726		Glute	130,7 × 155,8 × 148,8	305
	FE9726B				
	FE9732		Back Extension	122,3 × 138,3 × 148,9	304
	FE9732B				



CODE



PRICE



NAME



DIMENSIONS (cm)

















PAGE

	FE97WS200		Weight Stack	—	306
	FE97WS235		Weight Stack	—	306
	FE97WS295		Weight Stack	—	306

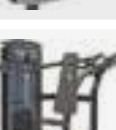
IT95 Line

	IT9501		Chest Press	147,5 × 119,1 × 150,6	311
	IT9501S				
	IT9502		Lat Pull	138,0 × 143,4 × 188,9	314
	IT9502S				
	IT9503		Arm Curl	120,8 × 122,5 × 150,7	313
	IT9503S				
	IT9504		Pectoral	144,9 × 136,1 × 150,7	312
	IT9504S				

 CODE	 PRICE	 NAME	 DIMENSIONS (cm)	 PAGE
	IT9505	Leg Extension	118,5 × 122,0 × 150,6	317
	IT9505S			
	IT9506	Seated Leg Curl	118,6 × 153,6 × 150,6	317
	IT9506S			
	IT9508	Abductor and Adductor	89,7 × 155,3 × 150,6	316
	IT9508S			
	IT9510	Leg Press	113,7 × 185,0 × 150,6	316
	IT9510S			
	IT9512	Shoulder Press	144,3 × 156,0 × 151,0	314
	IT9512S			
	IT9514	AB Machine	114,8 × 134,6 × 158,1	315
	IT9514S			

	 CODE	 PRICE	 NAME	 DIMENSIONS (cm)	 PAGE
	IT9515		Pec Fly / Rear Delt	127,5 × 127,1 × 204,8	312
	IT9515S				
	IT9516		Calf Raise	115,6 × 128,7 × 173,9	317
	IT9516S				
	IT9517		Dip Press	123,3 × 169,4 × 150,6	312
	IT9517S				
	IT9518		Torso Rotation	119,0 × 114,9 × 150,6	315
	IT9518S				
	IT9519		Row	126,4 × 161,6 × 150,6	314
	IT9519S				
	IT9520		Weight Assisted Chin / Dip Combo	157,3 × 131,5 × 228,6	312
	IT9520S				

 CODE	 PRICE	 NAME	 DIMENSIONS (cm)	 PAGE	
	IT9521		Prone Leg Curl	114,5 × 145,8 × 150,6	316
	IT9521S				
	IT9522		Lat Pulldown / Vertical Row	122,3 × 189,7 × 222,8	313
	IT9522S				
	IT9524		Lateral Raise	121,3 × 122,2 × 150,6	314
	IT9524S				
	IT9525		Adjustable Hi/Lo Pulley	146,3 × 126,2 × 235,8	311
	IT9525S				
	IT9526		Glute	121,7 × 161,5 × 150,6	316
	IT9526S				
	IT9527		4 Stack Multi-Station	221,4 × 348,9 × 238,2	311
	IT9527S				



CODE



PRICE



NAME



DIMENSIONS (cm)



PAGE

	IT9527OPTS		Cable Crossover Traditional	282,4 × 47,7 × 22,1	310
	IT9527OPT				
	IT9528		Leg Extension / Leg Curl	123,0 × 137,5 × 150,6	317
	IT9528S				
	IT9529		Multi Press	143,7 × 182,7 × 166,9	313
	IT9529S				
	IT9530		Dual Adjustable Pulley	162,0 × 137,0 × 227,0	311
	IT9530S				
	IT9532		Back Extension	118,8 × 123,3 × 150,6	315
	IT9532S				
	IT9533		Bicep/Tricep	122,5 × 130,0 × 150,6	313
	IT9533S				

	CODE	PRICE	NAME	DIMENSIONS (cm)	PAGE
	IT9534		Abdominal / Back Extension	118,9 × 119,6 × 150,6	315
	IT9534S				
	IT95WS160		Weight Stack	—	310
	IT95WS200		Weight Stack	—	310
	IT95WS235		Weight Stack	—	310
	IT95WS295		Weight Stack	—	310

IF93 Line

	IF9301		Chest Press	136,0 × 118,8 × 153,0	321
	IF9302		Lat Pulldown	131,8 × 158,3 × 189,1	324
	IF9303		Arm Curl	102,8 × 121,6 × 153,0	323
	IF9304		Pectoral	173,6 × 80,6 × 153,0	321
	IF9305		Leg Extension	104,8 × 114,6 × 153,0	326

 CODE	 PRICE	 NAME	 DIMENSIONS (cm)	 PAGE
	IF9306	Seated Leg Curl	103,4 × 144,8 × 153,0	326
	IF9308	Adbuctor / Adductor	93,5 × 157,0 × 153,0	326
	IF9310	Leg Press	116,8 × 205,5 × 153,0	327
	IF9312	Shoulder Press	145,6 × 145,0 × 153,0	323
	IF9314	Abdominal	100,8 × 108,5 × 153,0	324
	IF9315	Pectoral	149,3 × 142,1 × 186,3	322
	IF9316	Calf Raise	110,5 × 115,0 × 177,5	326
	IF9317	Seated Dip	121,2 × 122,7 × 153,0	323
	IF9318	Torso Rotation	124,0 × 110,3 × 153,0	325
	IF9319	Vertical Row	85,8 × 180,4 × 153,0	324
	IF9320	Weight Assisted Chin / Dip Combo	130,9 × 125,6 × 249,8	322
	IF9321	Prone Leg Curl	114,6 × 150,7 × 153,0	327

 CODE	 PRICE	 NAME	 DIMENSIONS (cm)	 PAGE	
	IF9322		Lat Pulldown	122,3 × 188,6 × 222,7	324
	IF9324		Lateral Raise	75,0 × 119,7 × 153,0	322
	IF9325		Adjustable Hi/Lo Pulley	144,9 × 125,8 × 233,8	321
	IF9326		Kick Back	106,8 × 103,4 × 153,0	325
	IF9327		4 Stack Multi-Station	244,5 × 342,7 × 233,8	321
	IF9327OPT		Cable Crossover Traditional	250,5 × 44,1 × 19,8	320
	IF9328		Leg Extension / Leg Curl	127,0 × 127,2 × 153,0 .	327
	IF9329		Multi-Press	144,6 × 202,6 × 153,0 .	322
	IF9330		Dual Adjustable Pulley	163,9 × 88,2 × 227,0.	320
	IF9332		Back Extension	103,4 × 112,0 × 153,0	325
	IF9333		Bicep Curl / Tricep Extension	120,3 × 132,7 × 153,0 .	323
	IF9335		Abductor	94,6 × 158,3 × 153,0	325



CODE



PRICE



NAME









DIMENSIONS (cm)



















PAGE

	IF9336		Adductor	118,5 × 158,3 × 153,0	327
	IF93WS160		Weight Stack	—	320
	IF93WS200		Weight Stack	—	320
	IF93WS235		Weight Stack	—	320
	IF93WS295		Weight Stack	—	320

IT70 Line

	IT7001		Smith	224,1 × 132,6 × 237,0	334
	IT7001B				
	IT7002		Seated Preacher Curl	80,0 × 95,3 × 88,2	331
	IT7002B				
	IT7003		AB Bench	93,5 × 174,8 × 106,3	332
	IT7003B				

 CODE	 PRICE	 NAME	 DIMENSIONS (cm)	 PAGE	
	IT7004		Stretch	55,2 × 127,4 × 99,7	333
	IT7004B				
	IT7005		Seated Calf Raise	75,1 × 135,5 × 83,9	333
	IT7005B				
	IT7006		Leg Press / Hack Squat	97,5 × 218,1 × 149,3	333
	IT7006B				
	IT7007		Multi Hyperextension	74,9 × 131,2 × 102,5	332
	IT7007B				
	IT7009		Flat Bench	74,9 × 120,0 × 42,6	334
	IT7009B				
	IT7010		Vertical Knee Raise / Dip Stand	78,1 × 113,1 × 151,5	331
	IT7010B				



CODE



PRICE



NAME















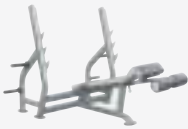

DIMENSIONS (cm)

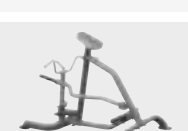

PAGE

	IT7010EOPT		Chin-Up Accessory	70,0 × 93,2 × 235,1	331
	IT7010EOPTB				
	IT7011		Multi-Adjustable Bench	75,1 × 121,7 × 105,9	334
	IT7011B				
	IT7012		Dumbbell Rack	158,0 × 81,4 × 98,2	335
	IT7012B				
	IT7013		Multi AB Bench	74,9 × 172,2 × 89,8	332
	IT7013B				
	IT7014		Flat Bench	165,8 × 165,7 × 137,3	330
	IT7014B				
	IT7015		Incline Bench	165,8 × 168,2 × 137,3	330
	IT7015B				

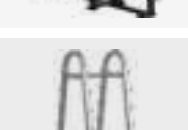
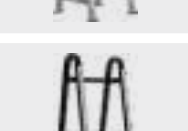
 CODE	 PRICE	 NAME	 DIMENSIONS (cm)	 PAGE	
	IT7016		Decline Bench	165,8 × 212,0 × 137,3	330
	IT7016B				
	IT7017		Weight Plate Tree	60,6 × 93,8 × 120,9	335
	IT7017B				
	IT7018		Dumbbell Rack	158,0 × 81,4 × 93,8	335
	IT7018B				
	IT7019		Incline Row	100,9 × 196,2 × 126,2	330
	IT7019B				
	IT7020		45 Leg Press	101,6 × 220,5 × 149,4	333
	IT7020B				
	IT7027		Barbell Rack	91,9 × 94,9 × 161,2	335
	IT7027B				



CODE



PRICE











NAME



DIMENSIONS (cm)















PAGE



	IT7030		Abdominal Bench	72,6 × 98,5 × 62,5 .	332
	IT7030B				
	IT7031		Shoulder Bench Press	134,9 × 112,6 × 165,1 .	331
	IT7031B				
	IT7032		Olympic Bar Rack	96,0 × 71,0 × 108,6	335
	IT7032B				
	IT7033		Max Rack	211,7 × 148,8 × 218,6	334
	IT7033B				

Encore Line

	ECE5		ECE5	81,2 × 184,9 × 178,0	343
	ECR7		ECR7	64,2 × 167,1 × 131,9	342
	ECT7		ECT7	94,0 × 205,1 × 145,9	343

				
CODE	PRICE	NAME	DIMENSIONS (cm)	PAGE
	ECU7	ECU7	62,8 × 113,2 × 147,2	342
	ES2000OPT1	Pivot	50,0 × 15,0 × 18,0	341
	ES2000OPT2	Pull Down Bar + Roller	126,5 × 25,5 × 13,0	341
	ES2100	ES2100	192,5 × 144,7 × 218,0	339
	ES3000	ES3000	364,2 × 292,9 × 217,7	338
	ES3000OPT	HiLo Pulley Attachment	37,6 × 81,9 × 214,5	341
	ES7011	Bench	52,5 × 144,0 × 49,0	341
	ES9030	ES9030	173,4 × 112,3 × 215,0	340

PL Line

	PL9002	Lat Pulldown / Seated Row	102,0 × 176,5 × 218,2	346
	PL9010	Leg Press / Calf Raise	114,7 × 216,5 × 152,0	347
	PL9016	Inner / Outer Thigh	173,9 × 160,9 × 152,0	347

CODE

PRICE

NAME

DIMENSIONS (cm)

PAGE

	PL9019		Leg Extension / Leg Curl	124,5 × 146,5 × 152,0	347
	PL9021		Multi Press	132,4 × 193,2 × 152,0	346
	PL9022		Rear Deltoid / Pectoral Fly	129,9 × 136,5 × 206,1	346
	PL9024		Ab / Low Back	109,9 × 104,4 × 152,0	346
	PLWS170		Weight Stack	—	347
	PLWS250		Weight Stack	—	347

IT93 Line

	IT9301 46161		Chest Press (91 kg weight stack included)	141,2 × 153,6 × 149,0	350
	IT9302 46254		Lat Pull (91 kg weight stack included)	137,5 × 145,1 × 190,0	350
	IT9305 4616501		Leg Extension (125 kg weight stack included)	118,1 × 133,9 × 149,0	352
	IT9306 46145		Seated Leg Curl (91 kg weight stack included)	116,2 × 163,0 × 149,0	351
	IT9309 4616301		Total Hip (125 kg weight stack included)	97,4 × 132,5 × 149,0	351

	CODE	PRICE	NAME	DIMENSIONS (cm)	PAGE
	IT9314 46157		Abdominal (91 kg weight stack included)	116,3 × 153,3 × 156,1	351
	IT9316 46160		Rotary Calf (91 kg weight stack included)	121,2 × 167,9 × 149,0	352
	IT9318 46158		Torso Rotation (91 kg weight stack included)	126,2 × 124,0 × 149,0	351
	IT9320 46170		Weight Assisted Chin / Dip Combo (91 kg weight stack included)	117,8 × 133,2 × 228,7	350
	IT9327 46187		4 Stack Station (4x91 kg weight stack included)	209,0 × 335,0 × 232,9	352
	IT9327 4618701		4 Stack Station (4x125 kg weight stack included)		352

IFP Line

	IFP1101		Seated Shoulder Press	157,9 × 152,0 × 106,9 .	356
	IFP1103		Standing Lateral Raise	116,5 × 88,5 × 155,0 .	356
	IFP1201		Seated Chest Press	127,6 × 98,4 × 124,8 .	356
	IFP1206		Standing Chest Fly	131,0 × 151,5 × 149,1 .	356
	IFP1301		Lat Pulldown Όργανο Έλξεων Πλάτης	70,8 × 109,2 × 128,7 .	357

CODE





PRICE

NAME

DIMENSIONS (cm)

PAGE

	IFP1302		Seated Row	102,0 × 147,0 × 134,0 .	357
	IFP1305		T-Bar Row Όρθια Κωπηλατική	207,9 × 90,8 × 63,5 .	358
	IFP1501		Bicep Curl Όργανο Κάμψεων Δικεφάλων	130,2 × 70,7 × 98,8 .	357
	IFP1604		Prone Leg Curl	120,2 × 162,3 × 79,8 .	359
	IFP1605		Seated Leg Extension	117,3 × 124,6 × 99,5 .	359
	IFP1613		Vertical Leg Press	165,5 × 121,4 × 171,1 .	360
	IFP1615		Belt Squat	125,0 × 161,5 × 103,2 .	360
	IFP1616		Vertical Hip Thrust	122,0 × 109,8 × 116,5 .	358
	IFP1617		Hack Squat	148,5 × 198,2 × 131,8 .	361
	IFP1619		Reverse Hyperextension	79,7 × 131,0 × 115,3 .	359
	IFP1622		Standing Hip Abductor	59,5 × 172,0 × 128,0 .	359
	IFP1623		Seated Calf Raise	56,6 × 136,8 × 84,9 .	360

 CODE	 PRICE	 NAME	 DIMENSIONS (cm)	 PAGE
	IFP1706		Biceps / Triceps	70,8 × 109,2 × 128,7 . 357
	IFP1707		Leverage Squat / Calf	144,5 × 149,0 × 155,0 . 360
	IFP1711		Hack Squat / Leg Press	102,0 × 263,4 × 137,3 . 361
	IFP1721		Half Cage / Smith Machine	185,0 × 140,4 × 234,3 . 358
	IFP1721OPT		Lat Pulldown Seated Row Attachment	123,1 × 145,1 × 230,7 . 358

Χάρτες των περιοχών στέγασης των εγκαταστάσεων της ΕΛΔΙΚΟ ΣΠΟΡ ΜΟΝ. ΑΕΕ σε Αθήνα και Θεσσαλονίκη



ΚΕΝΤΡΙΚΟ ΚΑΤΑΣΤΗΜΑ: Κασσάνδρας 30, Τ.Κ.: 104 47 Αθήνα (Βοτανικός) • Τηλ.: 210 34 78 279 (6 γραμμές), Fax: 210 34 50 168

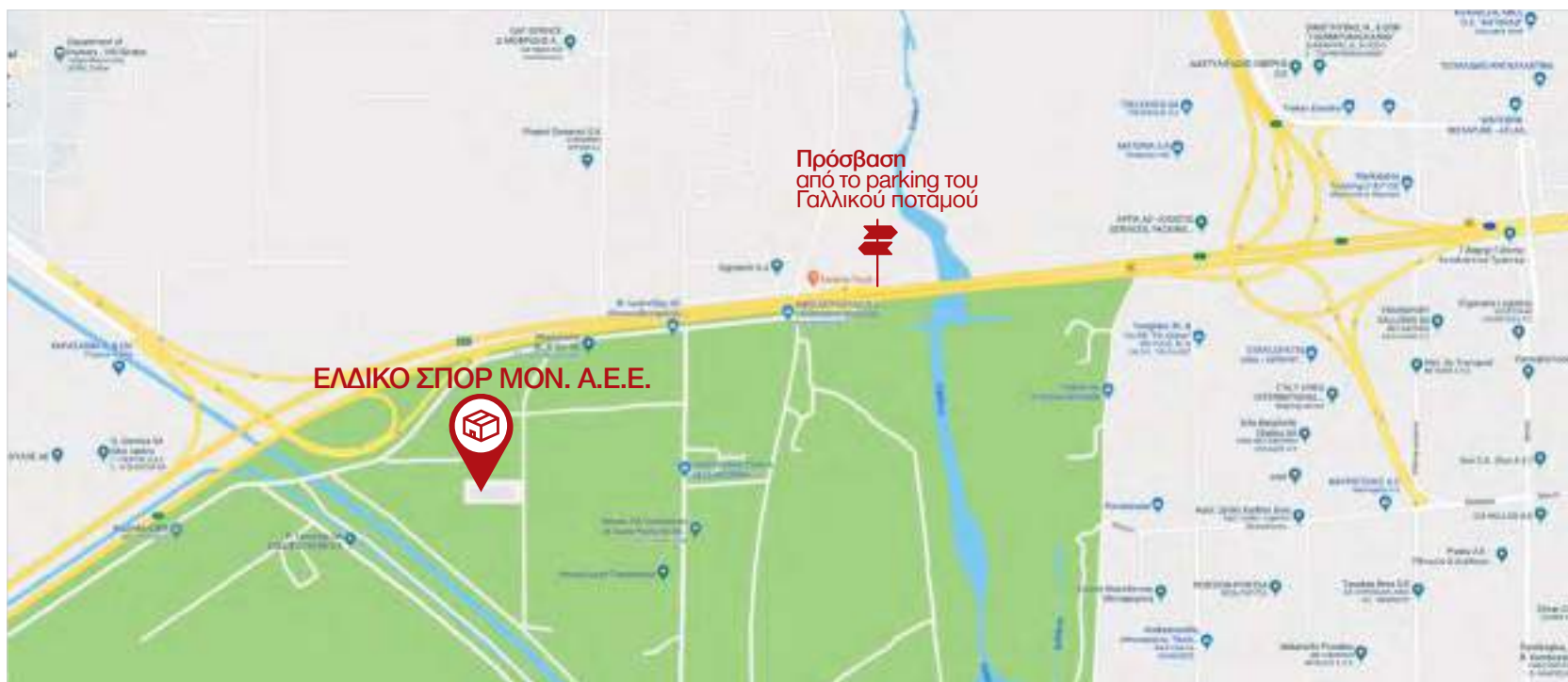

ΥΠΟΚΑΤΑΣΤΗΜΑ: 8^ο χλμ. Θεσ/νίκης-Αθήνας, Τ.Κ.: 574 00 Σίνδος (Θεσ/νίκη) • Τηλ.: 2310 57 00 37 (4 γραμμές), Fax: 2310 79 69 58

AMiLA SPIRIT SOLE TOTALGYM MİKASA FOX40 Butterfly. STAG

Για την αποστολή επιταγών μπορείτε να χρησιμοποιήσετε: Γενική Ταχυδρομική, Speedex Courier και Συστημένη Επιστολή των Ελληνικών Ταχυδρομείων (ΕΛΤΑ) - ΠΡΟΣΟΧΗ: για ταχυδρομικές αποστολές μόνο στη διεύθυνση Αθηνών

**ΤΡΑΠΕΖΙΚΟΙ
ΛΟΓΑΡΙΑΣΜΟΙ
ΚΑΤΑΘΕΣΕΩΝ**

EuroBank: 00260204250200103614
IBAN: GR 7002602040000250200103614

AlphaBank: 105002002018462
IBAN: GR 9201401050105002002018462

ΠΕΙΡΑΙΩΣ: 5082023708714
IBAN: GR 2601720820005082023708714

ΕΘΝΙΚΗ: 138/470625-05
IBAN: GR 6601101380000013847062505

Σημαντική Προσθήκη: παρακαλούμε στην “αιτιολογία” να αναγράφεται πάντοτε η επωνυμία της επιχείρησης

κατάλογος και
τιμοκατάλογος

2024

Σύμβουλος Αγορών

AMILA®

in impulse

ReNeGaDE

SPIRIT

SOLE

TOTAL GYM 

BODYCRAFT

Κεντρική Αποθήκη: ΚΑΣΣΑΝΔΡΑΣ 30, Τ.Κ. 104 47
ΑΘΗΝΑ (ΒΟΤΑΝΙΚΟΣ)

Τηλ. Κέντρο: 210 34 78 279 (6 γραμμές), Fax: 210 34 50 168

Υπ/μα Β. Ελλάδος: 8° χλμ. ΘΕΣ/ΝΙΚΗΣ - ΑΘΗΝΩΝ
Τ.Κ. 574 00 ΣΙΝΔΟΣ (ΘΕΣΣΑΛΟΝΙΚΗ)

Τηλ. Κέντρο: 2310 57 00 37 (4 γραμμές), Fax: 2310 79 69 58

e-mail: support@eldico.gr • web site: <http://www.eldico.gr/>

ELDICO
sport

ISO 9001
BUREAU VERITAS
Certification



In conformity with the
alternative packing
management system























www.amiLa.gr

























AMILA *in* impulse ReNeGaDE SPIRIT SOLE TOTALGYM 
BODYCRAFT MIKASA FOX40 SUNFLEX  Butterfly STAG

News/Updates

CHANGES IN THE CATALOGUE

 = IMPORTANT CHANGE /  = NEW ITEM /  = SMALL CHANGE IN SPECS /  = PRICE CHANGE

Date	Code	Change	Go
09/02/2024	95340	7lt Tactical Chest Bag	
02/02/2024	—	Impulse's IFP line just keeps on growing, go have a look...	
	95910-95911	NBR mats, 90 kg/m ³ density, dimensions 183x60cm x 15mm, with belt for storage, in grey and black color	
29/11/2023	IT70 line	This line of products is now also available in black color	
	FE97 line	This line of products is now also available in black color	
20/10/2023	—	This is the new version of our catalogue, with freshly pages for the commercial machines	—
	IT7005B	Well known machines by Impulse, now also in black color	
	IT7007B		
	IT7009B		
	IT7012B		
	IT7014B		
	96629	Multi-grip soft-strap tricep rope	
	96907	Gym towel with stitched pocket on the back to safely attach to the top of exercise benches	
	83332-83335	Neoprene weight lifting belts with pillow, 15cm wide	
	83336-83339	Leather weight lifting belts with pillow, genuine C' quality leather, 10cm wide, suede lining	
	44301-44302	Leather weight lifting belts with pillow, genuine A' quality leather, 10cm wide, suede lining	
	96905	Reformer towel with 2 Special covers for the Pilates bed	
	94920-94923	Leather weight lifting belts with pillow, genuine B' quality leather, 15cm wide, suede lining	
	45734	10m elastic band with velcro fastening on both ends	
	96831-96835	Cotton Yoga Belt in 4 colors, one of which made from Organic Cotton	
	96843-96844	Mint and Beige colored Yoga blocks	
	48193	Commercial Grade Balance Ball in black color	
	95110	12m Battle Rope	

Date	Code	Change	Go
	84588	36kg Competition Kettlebell	
	95312-95314	Liquid chalk, 3 bottles of different quantities	
	96920-96921	Swings for aerial yoga, 5 & 6 meters long, in black color	
	94251	Safe Squat Transpose Bar	
	92223	Eolos F300PI treadmill	
	92230	VELOS F200PI treadmill	
	92231	VELOS F300PI treadmill	
	92232	VELOS NF400PI treadmill	
	44807	Sole F80 Treadmill (2023 model)	
	44806	Sole F65 Treadmill (2023 model)	
	44805	Sole F63 Treadmill (2023 model)	
	44801	Spirit CT800+ Treadmill	
	43366	Spirit CR800+ Recumbent Bike	
	43394	Spirit CE800+ Elliptical	
	95200	Power Rack Compact Training Camp with lots of accessories to customize it according to your needs	
	90473, 90474, 90476	More sizes of 100% natural rubber kettlebells	
	83280	Head harness	
	94900	Dip belt	
	94901	Dip belt reinforced	
	95139	Drop Pad	
	95136	Plyometric box with 50, 60 & 75cm sides	
	37140-37143	"Re-Born" Boxing Gloves	
	46074	Full Spectrum 3 person infrared sauna	
25/07/2023	44729	RFT Functional Trainer (for F430 Power Rack)	
	44718	F430 Power Rack	
	41910	Pocket Gym Timer	
	95309	Crossfit TireFlip 180°	